



VRF catalogue 50/60Hz



Carrier VRF 2021
Cat-V.01

The specifications, designs, and information in this brochure are subject to change without notice

Products Lineup

Super X/Xi Series

Capacity Range	HP	8	10	12	14	16	18	20	22	24	26	28	30	32
	KW	25.2	28.0	33.5	40.0	45.0	50.0	56.0	61.5	67	73	78.5	85	90
	Btu/h	86,000	95,500	114,300	136,500	153,500	170,600	191,100	209,800	228,600	249,100	267,800	290,000	307,100
Appearance														

Super XC Series

Capacity Range	HP	8	10	12	14	16	18	20	22	24	26	28	30
	KW	22.4	28.0	33.5	40.0	45.0	50.0	56.0	61.5	67.0	73.0	78.5	85.0
	kBtu/h	76.5	95.6	114.4	136.6	153.7	170.8	191.3	210.0	228.8	249.3	268.1	290.3
Appearance													

Super Plus Series

Capacity Range	HP	8	10	12	14	16	18	20	22
	KW	25.2	28.0	33.5	40.0	45.0	50.0	56.0	61.5
	Btu/h	86,000	95,500	114,300	136,500	153,500	170,600	191,100	209,800
Appearance									

Super XR Series

Capacity Range	HP	8	10	12	14	16	18	20
	KW	22.4	28.0	33.5	40.0	45.0	50.0	56.0
	Btu/h	76,500	95,500	114,300	136,500	153,500	170,600	191,000
Appearance								

Water Cooled VRF Series

Capacity Range	HP	8	10	12
	KW	25.2	28.0	33.5
	Btu/h	86,000	95,500	114,300
Appearance				

Side discharge Series

Capacity Range	HP	3	4	4	5	6	7	8	10	12	14	16
	KW	8	10.5	12	14	16	20	22.4	26	33.5	40	45
	Btu/h	27,300	35,830	40,950	47,770	54,600	68,240	76,430	88,700	105,190	136,480	153,540
Appearance												

CONTENTS



- >> 03 Super X/Xi Series
- >> 20 Super XC Series
- >> 31 Super Plus Series
- >> 43 Super XR Series
- >> 51 Water Cooled VRF Series
- >> 57 Side discharge Series
- >> 73 2nd Generation VRF DC Indoor Units
- >> 90 Control Solutions
- >> 119 BMS Gateway
- >> 143 PURO - AIR KIT
- >> 147 Heat Recovery Ventilator
- >> 152 Branch Joints

Super X Series Heat Pump VRF



3 Unique Innovations

Energy Management System (EMS)

- Floating refrigerant temperature to balance comfort and efficiency
The evaporating temperature (in cooling) and condensing temperature (in heating) are automatically adjusted according to both indoor and outdoor temperature to maximize the comfort and energy efficiency.
- Output limitation during electricity supply restrictions
With the integration of EMS, for projects with temporary electricity supply restrictions, Super X can be set to output 40-100% capacity.

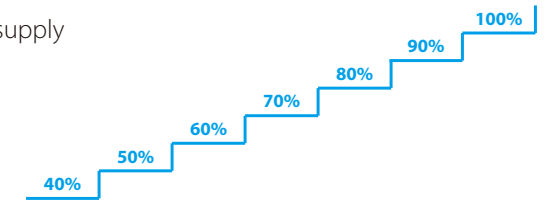
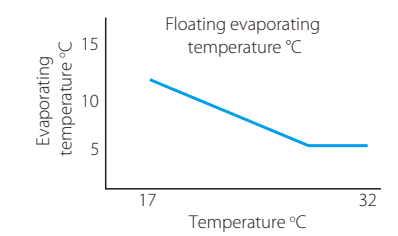

Enhanced Vapor Injection (EVI) Compressor

Thanks to the vapor injection DC inverter compressor, the Super X VRF can run heating mode stably down to -23°C, and the heating capacity can be improved greatly.

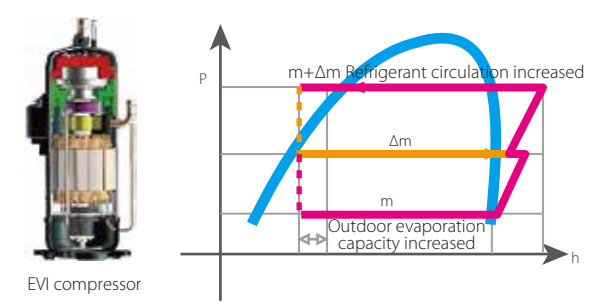

Triple Configurations

Triple (local/remote/network) configurations greatly simplified installation, commissioning and servicing.

- Field local configuration achieves quick and easy on-site settings, simplifies installation and commissioning.
- System checking and settings also can be easily achieved via wired and centralized controller, making the configuration more flexible and convenient.
- A desktop or laptop PC can be used for browser-based access to achieve system configurations through IMM Pro gateway via a LAN connection.



High Efficiency

Plate Heat Exchanger (PHE) Subcooling

Plate Heat Exchanger as a secondary intercooler boosts up refrigerant subcooling and improves 10% energy efficiency.

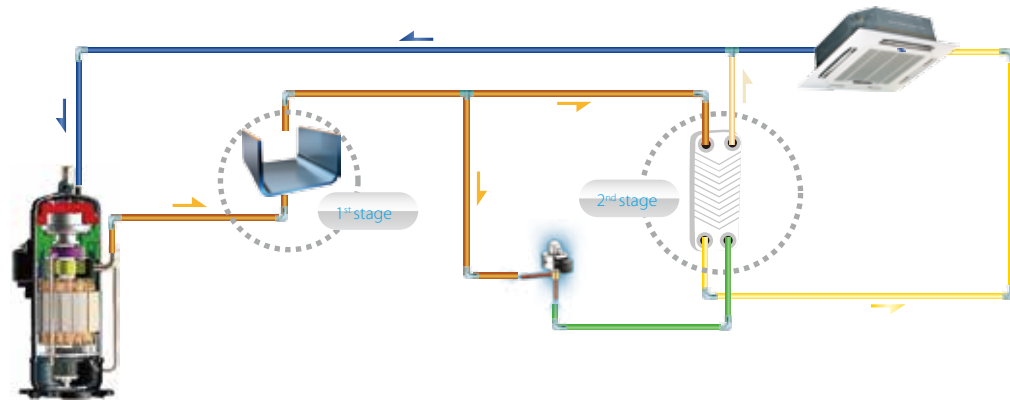

High Efficiency G-Type Heat Exchanger

24-32HP units use a high efficiency 3-row G-type heat exchanger with a heat exchange area 1.5 times that of the 22HP unit. The 24-32HP units also use super big size fan which diameter is up to 750mm.



3-rows G-type heat exchanger



Super big size fan

Wide Application Range

Wide Capacity Range

Starting at 8HP, capacity increases in 2HP increments up to 96HP, which is the world's largest single-system VRF capacity. (Samples below show 380V unit, for 220V please reference specification and combination table)

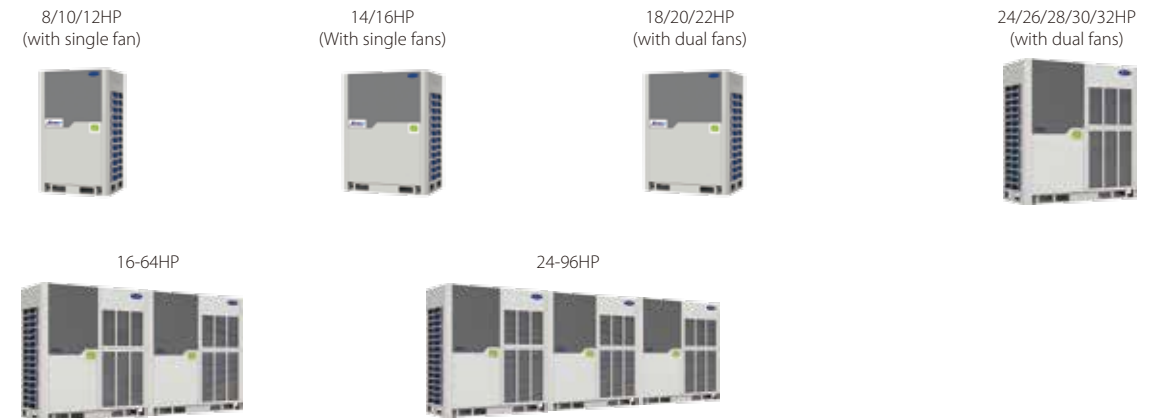

Wide Operation Range

The Super X VRF can operate stably in a wide ambient temperature range: from -5°C to 54°C in cooling mode and from -25°C to 24°C in heating mode.

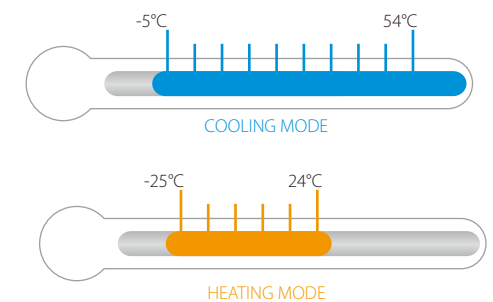

- Total piping length: 1000m
- Longest piping length – actual (equivalent): 175m (200m)
- Longest piping length after first branch: 90m
- Level difference between IDUs and ODU – ODU above (below): 90m (110m)
- Level difference between IDUs: 30m

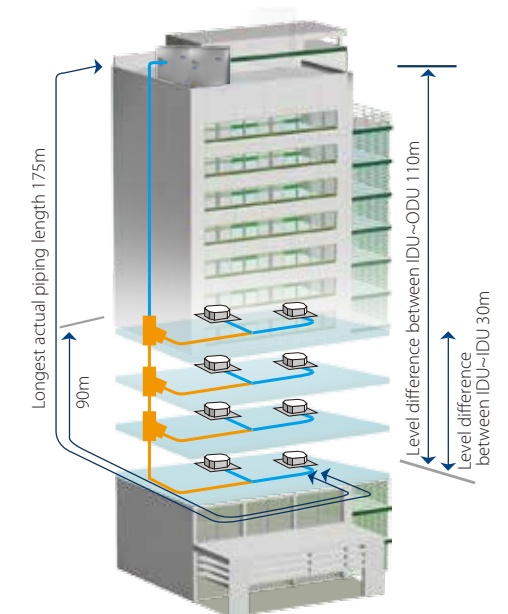

High Reliability

Duty Cycling

Duty cycling equalizes the running time of the outdoor units in a multiple-unit system and of the compressors in each unit, significantly extending compressor lifespan.(Super X)

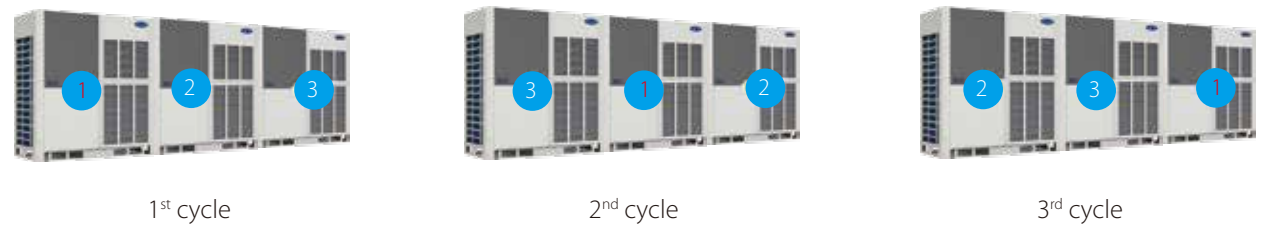

Precise Oil Control Technology

Four stages of oil control technology ensure all outdoor compressor oil is always kept at a safe level, eliminating any compressor oil shortage problems.

- Compressor internal oil separation.
- High-efficiency centrifugal oil separator (with separation efficiency of up to 99%) ensures that oil is separated from the discharge gas and returned to the compressors in a timely fashion.
- Oil balance pipes between compressors ensure even oil distribution to keep compressors running normally.
- Auto oil return program monitors the running time and system status to ensure reliable oil return.

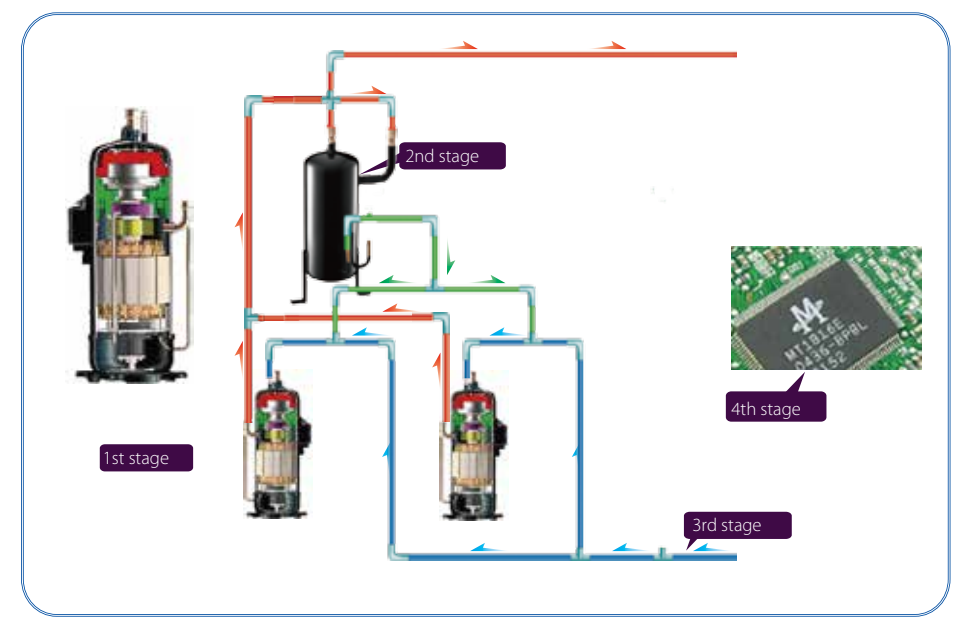

High Reliability

Backup Operation

In units with two compressors, if one compressor fails, the other compressor can run on its own for up to 4 days, allowing time for maintenance or repair whilst maintaining comfort.

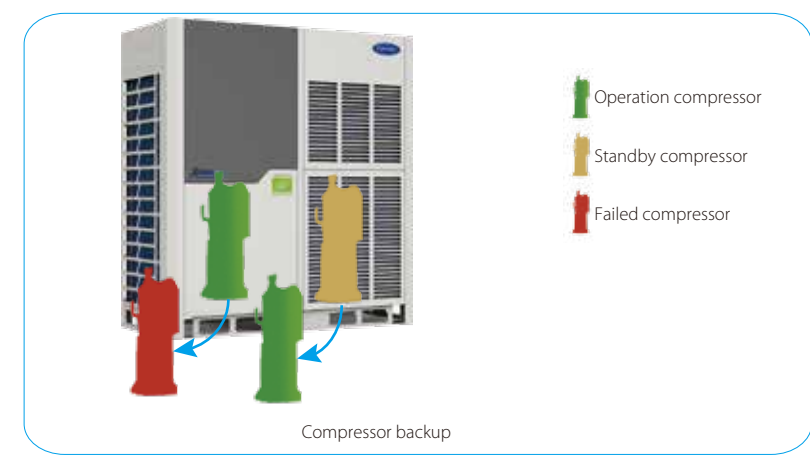

Anti-corrosion Protection

Outdoor units are given anti-corrosion treatment for non-extreme conditions as standard and can also be customized with heavy anti-corrosion treatment on main components for surface protection against corrosive air, acid rain and saline air (for installations in coastal regions) to extend overall useful life. The integrity of the anti-corrosion treatment is ensured by subjecting major components and parts to salt mist testing, moisture and heating testing and light aging testing.

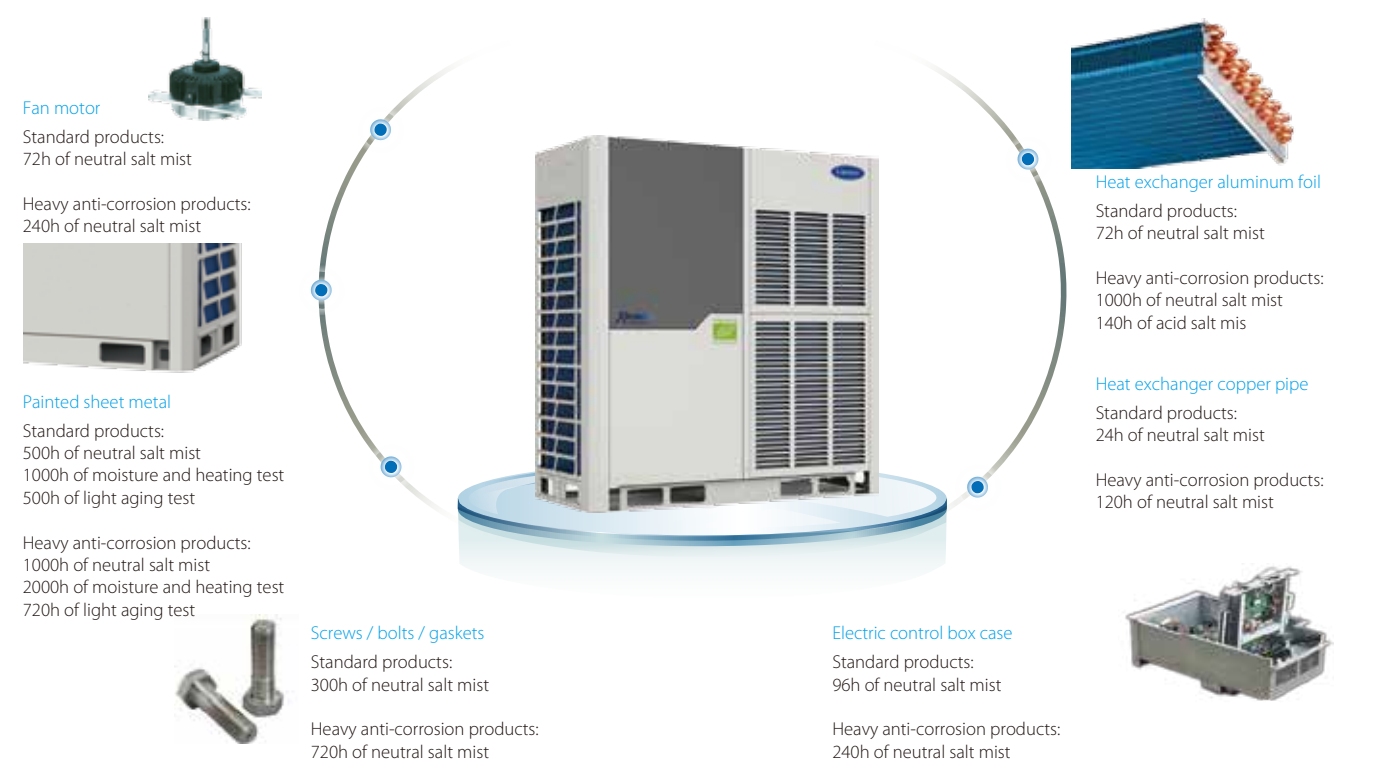

High Reliability

Refrigerant Cooling PCB

The Super X VRF uses refrigerant cooling technology to cool the electric control box. It decreases the average temperature of electrical control components by about 8 degrees, guaranteeing the stable and safe running of the control system.

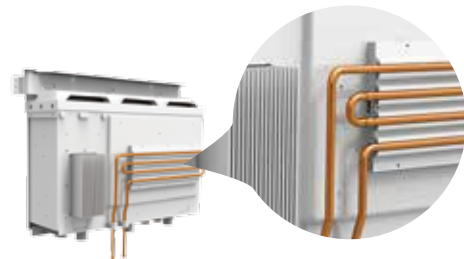

Real-time Refrigerant Amount Monitoring

The temperature and pressure of refrigerant can be real-time monitored by the outdoor unit. When the level of refrigerant is too low or too high, this can cause damage to the unit and poor performance. Super X outdoor unit can detect excessive or insufficient amounts of refrigerant, to ensure consistent performance.

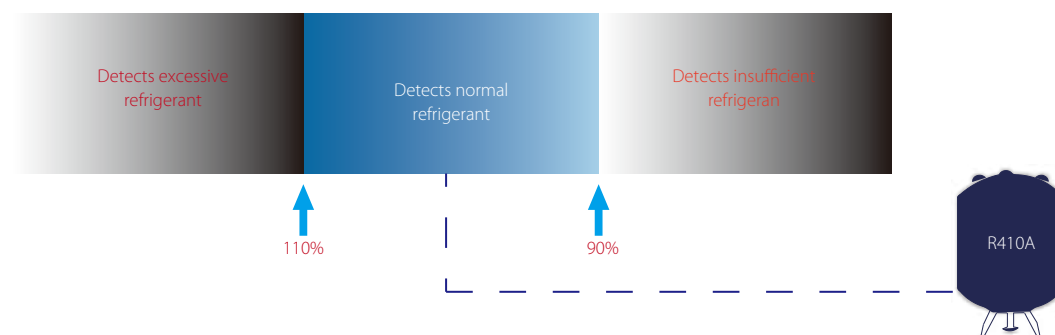

Auto Snow-blowing Function*

The innovatively designed auto snow-blowing function enables the outdoor unit to prevent the accumulation of snow by itself.

*This function is available as a customization option.



Dust-clean function*

The innovatively designed dust-clean function enables the outdoor unit to prevent the dust by itself.

*This function is available as a customization option.



Enhanced Comfort

Night Silent Mode

The night silent mode feature, which is easily configured on the outdoor unit's PCB, includes various scheduling options that can be used to reduce noise levels at times when low noise operation is required.

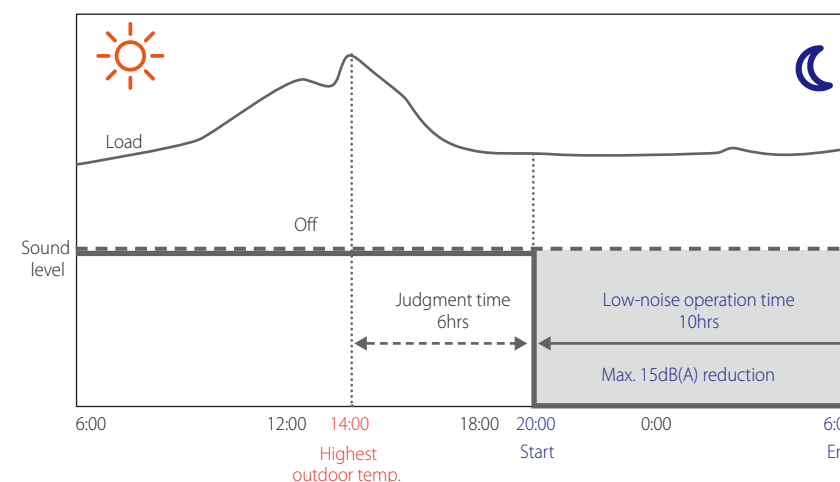

Enhanced Heating Capacity

Heating capacity is 100% of rated capacity at ambient temperatures as low as -5°C and 90% of rated capacity at -15°C.

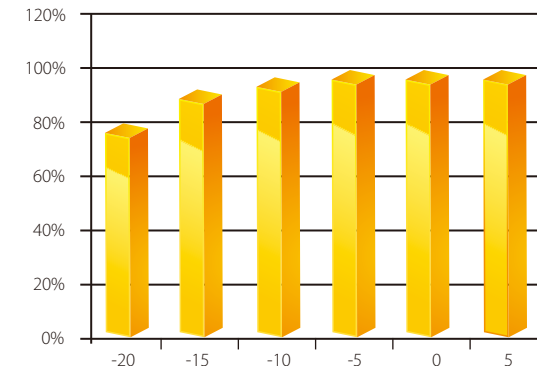

Intelligent Defrosting Technology

The intelligent defrosting program calculates the time required for defrosting according to the actual system status, eliminating heat losses from unnecessary defrosting. A specialized defrosting valve reduces time required for defrosting to as little as four minutes.

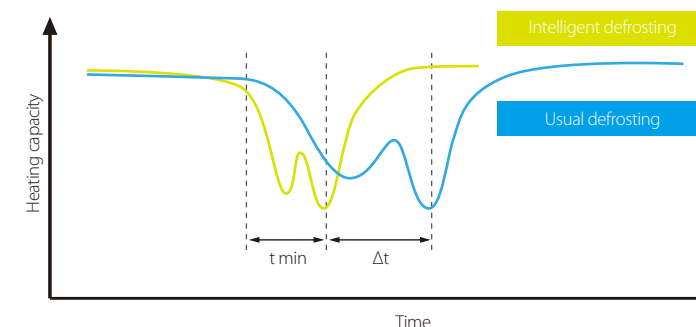

Easy Installation and Service

Non-polarized Communication Wiring*

Only one chain of 2-core non-polarized shielded communication wiring required for indoor and outdoor unit communication.

*In installations where relatively strong electromagnetic fields are present, 3-core shielded wiring should be used in order to prevent interference.

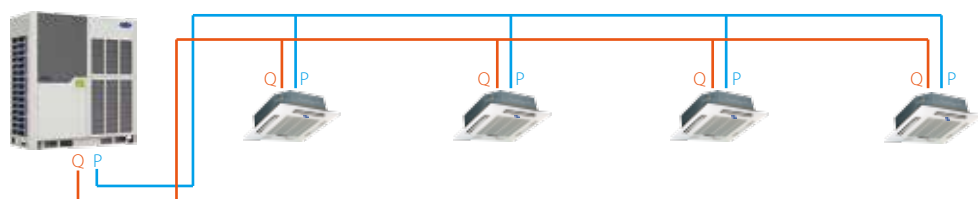

Auto Addressing

Outdoor units can distribute addresses to indoor units automatically. Remote and wired controllers can be used to query or modify each indoor unit's address.

Automatic Refrigerant Charging/Recycling Function*

Automatic refrigerant charging and recycling make installation and service easier and more efficient.

*This function is available as a customization option.

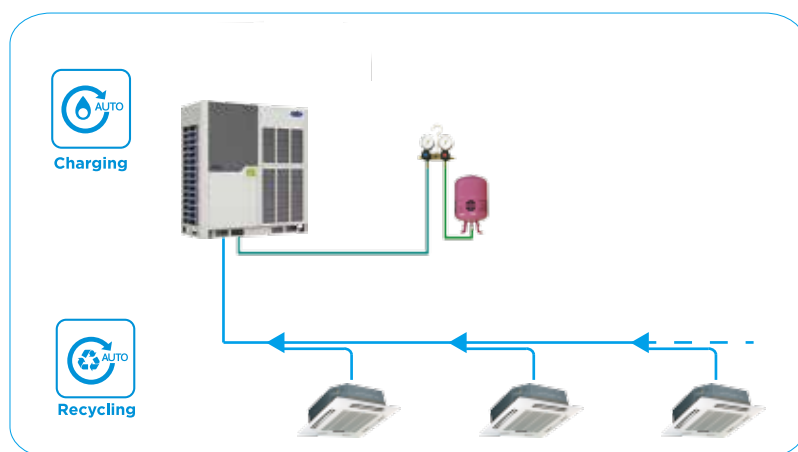

Optional Multifunctional PCB

An optional multifunctional small PCB can be installed on the unit's side columns, enabling installation and service engineers to activate Auto-commissioning or check the operating status without removing the front panel. It can also perform automatic data backup of the last 30 minutes' operating record.



Specifications(Super X 380V)



Capacity	HP	8	10	12	14	
Model		38VF008H119016	38VF010H119016	38VF012H119016	38VF014H119016	
Power supply	V/Ph/Hz	380-415/3/50(60)				
Cooling ¹	Capacity	kW	25.2	28.0	33.5	40.0
		kBtu/h	86.0	95.5	114.3	136.5
	Power input	kW	5.3	6.3	8.7	9.9
Heating ²	EER	kW/kW	4.75	4.45	3.85	4.05
	Capacity	kW	25.2	28.0	33.5	40.0
		kBtu/h	86.0	95.5	114.3	136.5
Connectable Indoor Unit	Power input	kW	4.6	5.2	6.6	8.5
	Max. quantity		13	16	20	23
Compressors	COP	kW/kW	5.50	5.40	5.10	4.70
	Total capacity		50-130% of outdoor unit capacity			
Fan motors	Type		DC inverter			
	Quantity		1			
Refrigerant	Type		DC			
	Quantity		1			
Pipe connections ³	Max. ESP	Pa	20 default; 60 customization option			
	Type		R410A			
Airflow rate	Factory charge	kg	11			
	Type		R410A			
Sound pressure level ⁴	Liquid pipe	mm	Φ12.7		Φ15.9	Φ15.9
	Gas pipe	mm	Φ25.4		Φ28.6	Φ31.8
Net dimensions (WxHxD)	m ³ /h		11000			13000
	dB(A)		58			60
Packed dimensions (WxHxD)	mm		990x1635x790			1340x1635x825
	mm		1090x1805x860			1405x1805x910
Net weight	kg		227			282
	kg		242			311
Ambient temp. operating range	Cooling	°C	-5 to 54			
	Heating	°C	-25 to 24			



Capacity	HP	16	18	20	22	
Model		38VF016H119016	38VF018H119016	38VF020H119016	38VF022H119016	
Power supply	V/Ph/Hz	380-415/3/50(60)				
Cooling ¹	Capacity	kW	45.0	50.0	56.0	61.5
		kBtu/h	153.5	170.6	191.1	209.8
	Power input	kW	12.0	12.5	15.1	18.4
Heating ²	EER	kW/kW	3.75	4.00	3.70	3.35
	Capacity	kW	45.0	50.0	56.0	61.5
		kBtu/h	153.5	170.6	191.1	209.8
Connectable Indoor Unit	Power input	kW	9.8	10.6	12.7	15.0
	Max. quantity		26	29	33	36
Compressors	COP	kW/kW	4.60	4.70	4.40	4.10
	Total capacity		50-130% of outdoor unit capacity			
Fan motors	Type		DC inverter			
	Quantity		2			
Refrigerant	Type		DC			
	Quantity		2			
Pipe connections ³	Max. ESP	Pa	20 default; 60 customization option			
	Type		R410A			
Airflow rate	Factory charge	kg	13		17	
	Type		R410A			
Sound pressure level ⁴	Liquid pipe	mm	Φ15.9		Φ19.1	
	Gas pipe	mm	Φ31.8		Φ31.8	
Net dimensions (WxHxD)	m ³ /h		13000		17000	
	dB(A)		61			63
Packed dimensions (WxHxD)	mm		1340x1635x825		1340x1635x790	
	mm				1405x1805x910	
Net weight	kg		282		352	
	kg		311		375	
Ambient temp. operating range	Cooling	°C	-5 to 54			
	Heating	°C	-25 to 24			

Notes:
 1. Indoor temperature 27°C DB, 19°C WB; outdoor temperature 35°C DB; equivalent refrigerant piping length 7.5m with zero level difference.
 2. Indoor temperature 20°C DB; outdoor temperature 7°C DB, 6°C WB; equivalent refrigerant piping length 7.5m with zero level difference.
 3. Diameters given are those of the unit's stop valves.
 4. Sound pressure level is measured at a position 1m in front of the unit and 1.3m above the floor in a semi-anechoic chamber.

Specifications(Super X 380V)



Capacity		HP	24	26	28
Model			38VF024H119016	38VF026H119016	38VF028H119016
Power supply		V/Ph/Hz	380-415/3/50(60)		
Cooling ¹	Capacity	kW	67.0	73.0	78.5
		kBtu/h	228.6	249.1	267.8
	Power input	kW	18.1	20.9	24.2
	EER	kW/kW	3.70	3.49	3.25
Heating ²	Capacity	kW	67.0	73.0	78.5
		kBtu/h	228.6	249.1	267.8
	Power input	kW	14.9	17.6	20.7
	COP	kW/kW	4.50	4.15	3.80
Connectable Indoor Unit	Total capacity	50-130% of outdoor unit capacity			
	Max. quantity		39	43	46
Compressors	Type	DC inverter			
	Quantity	2			
Fan motors	Type	DC			
	Quantity	2			
	Max. ESP	Pa	20 default; 60 customization option		
Refrigerant	Type	R410A			
	Factory charge	kg	22		
Pipe connections ³	Liquid pipe	mm	Φ19.1	Φ22.2	
	Gas pipe	mm	Φ31.8	Φ31.8	
Airflow rate		m ³ /h	25000		
Sound pressure level ⁴		dB(A)	64		
Net dimensions (WxHxD)		mm	1730 × 1830 × 825		
Packed dimensions (WxHxD)		mm	1800×2000×910		
Net weight		kg	435		
Gross weight		kg	458		
Ambient temp. operating range	Cooling	°C	-5 to 54		
	Heating	°C	-25 to 24		



Capacity		HP	30	32
Model			38VF030H119016	38VF032H119016
Power supply		V/Ph/Hz	380-415/3/50(60)	
Cooling ¹	Capacity	kW	85.0	90.0
		kBtu/h	290.0	307.1
	Power input	kW	27.4	31.0
	EER	kW/kW	3.10	2.90
Heating ²	Capacity	kW	85.0	90.0
		kBtu/h	290.0	307.1
	Power input	kW	23.0	25.7
	COP	kW/kW	3.70	3.50
Connectable Indoor Unit	Total capacity	50-130% of outdoor unit capacity		
	Max. quantity		50	53
Compressors	Type	DC inverter		
	Quantity	2		
Fan motors	Type	DC		
	Quantity	2		
	Max. ESP	Pa	20 default; 60 customization option	
Refrigerant	Type	R410A		
	Factory charge	kg	25	
Pipe connections ³	Liquid pipe	mm	Φ22.2	
	Gas pipe	mm	Φ38.1	
Airflow rate		m ³ /h	24000	
Sound pressure level ⁴		dB(A)	64	
Net dimensions (WxHxD)		mm	1730 × 1830 × 825	
Packed dimensions (WxHxD)		mm	1800×2000×910	
Net weight		kg	480	
Gross weight		kg	512	
Ambient temp. operating range	Cooling	°C	-5 to 54	
	Heating	°C	-25 to 24	

- Notes:
- Indoor temperature 27°C DB, 19°C WB; outdoor temperature 35°C DB; equivalent refrigerant piping length 7.5m with zero level difference.
 - Indoor temperature 20°C DB; outdoor temperature 7°C DB, 6°C WB; equivalent refrigerant piping length 7.5m with zero level difference.
 - Diameters given are those of the unit's stop valves.
 - Sound pressure level is measured at a position 1m in front of the unit and 1.3m above the floor in a semi-anechoic chamber.

Recommended combination table

Model	No. of units	No. of compressor	Modules ¹														Max No. of connectable indoor unit	Cooling/heating capacity	
			8	10	12	14	16	18	20	22	24	26	28	30	32	kW		kBtu/h	
8	1	1	•														13	25.2	86.0
10	1	1		•													16	28	95.5
12	1	1			•												20	33.5	114.3
14	1	1				•											23	40	136.5
16	1	1					•										26	45	153.5
18	1	2						•									29	50	170.6
20	1	2							•								33	56	191.1
22	1	2								•							36	61.5	209.8
24	1	2									•						39	67	228.6
26	1	2										•					43	73	249.1
28	1	2											•				46	78.5	267.8
30	1	2												•			50	85	290.0
32	1	2													•		53	90	307.1
34	2	3			•										•		56	95	324.1
36	2	3				•									•		59	101.5	346.3
38	2	3					•								•		63	106.5	363.4
40	2	3			•			•							•		64	112	382.1
42	2	4							•						•		64	117.5	400.9
44	2	4												•	•		64	123	419.7
46	2	4												•	•		64	128.5	438.4
48	2	4												•	•		64	134.5	458.9
50	2	4												•	•		64	140	477.7
52	2	4												•	•		64	146	498.2
54	2	4												•	•		64	151.5	516.9
56	2	4												•	•		64	157	535.7
58	2	4												•	•		64	163.5	557.9
60	2	4												•	•		64	168.5	574.9
62	2	4												•	•		64	175	597.1
64	2	4												•	•		64	180	614.2
66	3	5			•									•	•		64	185	631.2
68	3	5				•								•	•		64	191.5	653.4
70	3	5					•							•	•		64	196.5	670.5
72	3	5			•									•	•		64	202	689.2
74	3	6							•					•	•		64	207.5	708.0
76	3	6												•	•		64	213	726.8
78	3	6												•	•		64	218.5	745.5
80	3	6												•	•		64	224.5	766.0
82	3	6												•	•		64	230	784.8
84	3	6												•	•		64	236	805.2
86	3	6												•	•		64	241.5	824.0
88	3	6												•	•		64	247	842.8
90	3	6												•	•		64	253.5	864.9
92	3	6												•	•		64	258.5	882.0
94	3	6												•	•		64	265	904.2
96	3	6												•	•		64	270	921.2

Notes:

Capacities are based on the following conditions:

Cooling: Indoor temperature 27°C(80.6°F) DB/19°C(66.2°F) WB; Outdoor temperature 35°C(95°F) DB/24°C(75.2°F) WB

Heating: Indoor temperature 20°C(68°F) DB/15°C(59°F) WB; Outdoor temperature 7°C(44.6°F) DB/6°C(42.8°F) WB

Piping length: Interconnecting piping length is 7.5m(24.6ft), level difference is zero.

The above combination models are factory-recommended models

Specifications(Super Xi 380V)



Capacity		HP	8	10	12
Model			38VF008H119011	38VF010H119011	38VF012H119011
Power supply		V/Ph/Hz	380-415/3/50(60)		
Cooling ¹	Capacity	kW	25.2	28	33.5
		kBtu/h	86	95.5	114.3
	Power input	kW	5.5	6.7	8.9
		EER	4.55	4.2	3.75
Heating ²	Capacity	kW	25.2	28	33.5
		kBtu/h	86	95.5	114.3
	Power input	kW	4.8	5.5	7.6
		COP	5.2	5.1	4.4
Connected indoor unit	Total capacity	50-130% of outdoor unit capacity			
	Maximum quantity		13	16	20
Compressors	Type	DC inverter			
	Quantity	1			
Fan motors	Type	DC			
	Quantity	1			
Refrigerant	Type	R410A			
	Factory charge	kg	11		
Pipe connections ³	Liquid pipe	mm	Φ12.7		Φ15.9
	Gas pipe	mm	Φ25.4		Φ28.6
Airflow rate		m ³ /h	11000		
Sound pressure level ⁴		dB(A)	58	58	60
Net dimensions (WxHxD)		mm	990x1635x790		
Packed dimensions (WxHxD)		mm	1090x1805x860		
Net weight		kg	227		
Gross weight		kg	242		
Ambient temp. operating range	Cooling	°C	-5 to 54		
	Heating	°C	-25 to 24		



Capacity		HP	14	16	18
Model			38VF014H119011	38VF016H119011	38VF018H119011
Power supply		V/Ph/Hz	380-415/3/50(60)		
Cooling ¹	Capacity	kW	40	45	50
		kBtu/h	136.5	153.5	170.6
	Power input	kW	11	12.9	14.7
		EER	3.65	3.5	3.4
Heating ²	Capacity	kW	40	45	50
		kBtu/h	136.5	153.5	170.6
	Power input	kW	9.3	10.7	12.2
		COP	4.3	4.2	4.1
Connected indoor unit	Total capacity	50-130% of outdoor unit capacity			
	Maximum quantity		23	26	29
Compressors	Type	DC inverter			
	Quantity	1			
Fan motors	Type	DC			
	Quantity	1			
Refrigerant	Type	R410A			
	Factory charge	kg	13		
Pipe connections ³	Liquid pipe	mm	Φ15.9		Φ19.1
	Gas pipe	mm	Φ31.8		Φ31.8
Airflow rate		m ³ /h	13000		
Sound pressure level ⁴		dB(A)	60	61	62
Net dimensions (WxHxD)		mm	1340x1635x825		
Packed dimensions (WxHxD)		mm	1405x1805x910		
Net weight		kg	282		300
Gross weight		kg	311		329
Ambient temp. operating range	Cooling	°C	-5 to 54		
	Heating	°C	-25 to 24		

Notes:

- Indoor temperature 27°C DB, 19°C WB; outdoor temperature 35°C DB; equivalent refrigerant piping length 7.5m with zero level difference.
- Indoor temperature 20°C DB; outdoor temperature 7°C DB, 6°C WB; equivalent refrigerant piping length 7.5m with zero level difference.
- Diameters given are those of the unit's stop valves.
- Sound pressure level is measured at a position 1m in front of the unit and 1.3m above the floor in a semi-anechoic chamber.

Specifications(Super Xi 380V)



Capacity		HP	20	22
Model			38VF020H119011	38VF022H119011
Power supply		V/Ph/Hz	380-415/3/50(60)	
Cooling ¹	Capacity	kW	56	61.5
		kBtu/h	191.1	209.8
	Power input	kW	16	20.2
		EER	3.5	3.05
Heating ²	Capacity	kW	56	61.5
		kBtu/h	191.1	209.8
	Power input	kW	13.8	17.6
		COP	4.05	3.5
Connected indoor unit	Total capacity	50-130% of outdoor unit capacity		
	Maximum quantity		33	36
Compressors	Type	DC inverter		
	Quantity	2		
Fan motors	Type	DC		
	Quantity	2		
Refrigerant	Type	R410A		
	Factory charge	kg	17	
Pipe connections ³	Liquid pipe	mm	Φ19.1	
	Gas pipe	mm	Φ31.8	
Airflow rate		m ³ /h	17000	
Sound pressure level ⁴		dB(A)	63	
Net dimensions (WxHxD)		mm	1340x1635x790	
Packed dimensions (WxHxD)		mm	1405x1805x910	
Net weight		kg	348	
Gross weight		kg	371	
Ambient temp. operating range	Cooling	°C	-5 to 54	
	Heating	°C	-25 to 24	



Capacity		HP	24	26	28	30	32
Model			38VF024H119011	38VF026H119011	38VF028H119011	38VF030H119011	38VF032H119011
Power supply		V/Ph/Hz	380-415/3/50(60)				
Cooling ¹	Capacity	kW	67	73	78.5	85	90
		kBtu/h	228.6	249.1	267.8	290	307.1
	Power input	kW	21.6	21.6	24.9	28.3	32.1
		EER	3.1	3.4	3.15	3	2.8
Heating ²	Capacity	kW	67	73	78.5	85	90
		kBtu/h	228.6	249.1	267.8	290	307.1
	Power input	kW	16.8	18.1	21.8	24.3	26.5
		COP	4	4.05	3.6	3.5	3.4
Connected indoor unit	Total capacity	50-130% of outdoor unit capacity					
	Maximum quantity		39	43	46	50	53
Compressors	Type	DC inverter					
	Quantity	2					
Fan motors	Type	DC					
	Quantity	2					
Refrigerant	Type	R410A					
	Factory charge	kg	22		25		
Pipe connections ³	Liquid pipe	mm	Φ19.1		Φ22.2		
	Gas pipe	mm	Φ31.8		Φ38.1		
Airflow rate		m ³ /h	25000				24000
Sound pressure level ⁴		dB(A)	64				
Net dimensions (WxHxD)		mm	1730x1830x825				
Packed dimensions (WxHxD)		mm	1800x2000x910				
Net weight		kg	412	434		480	
Gross weight		kg	435	457		512	
Ambient temp. operating range	Cooling	°C	-5 to 54				
	Heating	°C	-25 to 24				

Notes:

- Indoor temperature 27°C DB, 19°C WB; outdoor temperature 35°C DB; equivalent refrigerant piping length 7.5m with zero level difference.
- Indoor temperature 20°C DB; outdoor temperature 7°C DB, 6°C WB; equivalent refrigerant piping length 7.5m with zero level difference.
- Diameters given are those of the unit's stop valves.
- Sound pressure level is measured at a position 1m in front of the unit and 1.3m above the floor in a semi-anechoic chamber.

Specifications(Super X 220V)



HP			8	10	12	14	16	
Model			38VF008H11B016	38VF010H11B016	38VF012H11B016	38VF014H11B016	38VF016H11B016	
Power supply	V/Ph/Hz	208-230/3/60&220-240/3/50						
Cooling ¹	Capacity	kW	25.2	28.0	33.5	40.0	45.0	
		kBtu/h	86.0	95.5	114.3	136.5	153.5	
	Power input (ISO)	kW	4.80	5.70	7.08	8.70	10.27	
	EER (ISO)	kW/kW	5.25	4.91	4.73	4.60	4.38	
Heating ²	Capacity	kW	25.2	28.0	33.5	40.0	45.0	
		kBtu/h	86.0	95.5	114.3	136.5	153.5	
	Power input(ISO)	kW	4.56	5.12	6.65	8.47	9.62	
	EER (ISO)	kW	5.53	5.47	5.04	4.72	4.68	
Connected indoor unit	Total capacity	50-130% of outdoor unit capacity						
	Maximum quantity		13	16	20	23	26	
Compressor	Type	DC inverter						
	Quantity	1						
Fan motor	Motor type	DC						
	Quantity	1						
Fan motor	Airflow rate	m ³ /h	11000	11000	11000	14000	14000	
	Static pressure	Pa	0-20 (default); 20-60 (customized)					
Refrigerant Pipe	Type	R410A						
	Factory charge	kg	11	11	11	13	13	
connections ³	Liquid pipe	mm	Φ12.7	Φ12.7	Φ15.9	Φ15.9	Φ15.9	
	Gas pipe	mm	Φ25.4	Φ25.4	Φ28.6	Φ31.8	Φ31.8	
Sound pressure level ⁴	dB(A)	58						
Net dimensions (WxHxD)	mm	990x1635x790				1340x1635x790		
Packed dimensions (WxHxD)	mm	1090x1805x860				1405x1805x910		
Net weight	kg	227	227	227	289	289		
Gross weight	kg	248	248	248	318	318		
Ambient temp.	Cooling	°C	-5 ~ 54					
	Heating	°C	-25 ~ 24					



HP			18	20	22	24	26	28	
Model			38VF018H11B016	38VF020H11B016	38VF022H11B016	38VF024H11B016	38VF026H11B016	38VF028H11B016	
Power supply	V/Ph/Hz	208-230/3/60&220-240/3/50							
Cooling ¹	Capacity	kW	50.0	56.0	61.5	67.0	73.0	78.5	
		kBtu/h	170.6	191.1	209.8	228.6	249.1	267.8	
	Power input (ISO)	kW	11.57	13.66	15.19	16.58	19.11	23.43	
	EER (ISO)	kW/kW	4.32	4.10	4.05	4.04	3.82	3.35	
Heating ²	Capacity	kW	50.0	56.0	61.5	67.0	73.0	78.5	
		kBtu/h	170.6	191.1	209.8	228.6	249.1	267.8	
	Power input (ISO)	kW	10.53	12.56	14.61	15.12	17.38	20.23	
	EER (ISO)	kW	4.75	4.46	4.21	4.43	4.20	3.88	
Connected indoor unit	Total capacity	50-130% of outdoor unit capacity							
	Maximum quantity		29	33	36	39	43	46	
Compressor	Type	DC inverter							
	Quantity	2							
Fan motor	Motor type	DC							
	Quantity	2							
Fan motor	Airflow rate	m ³ /h	17000	17000	17000	25000	25000	25000	
	Static pressure	Pa	0-20 (default); 20-60 (customized)						
Refrigerant Pipe	Type	R410A							
	Factory charge	kg	17	17	17	21	21	21	
connections ³	Liquid pipe	mm	Φ19.1	Φ19.1	Φ19.1	Φ19.1	Φ22.2	Φ22.2	
	Gas pipe	mm	Φ31.8	Φ31.8	Φ31.8	Φ31.8	Φ31.8	Φ31.8	
Sound pressure level ⁴	dB(A)	62							
Net dimensions (WxHxD)	mm	1340x1635x790				1730x1830x825			
Packed dimensions (WxHxD)	mm	1405x1805x910				1800x2000x910			
Net weight	kg	370	370	370	443	443	443		
Gross weight	kg	393	393	393	466	466	466		
Ambient temp.	Cooling	°C	-5 ~ 54						
	Heating	°C	-25 ~ 24						

- Notes:
- Indoor temperature 27°C DB, 19°C WB; outdoor temperature 35°C DB; equivalent refrigerant piping length 7.5m with zero level difference.
 - Indoor temperature 20°C DB; outdoor temperature 7°C DB, 6°C WB; equivalent refrigerant piping length 7.5m with zero level difference.
 - Diameters given are those of the unit's stop valves.
 - Sound pressure level is measured at a position 1m in front of the unit and 1.3m above the floor in a semi-anechoic chamber.

Recommended combination table

Model	No. of units	No. of compressor	Modules ¹											Max No. of connectable indoor unit	Cooling/heating capacity		
			8	10	12	14	16	18	20	22	24	26	28		kW	kBtu/h	
8	1	1	•												13	25.2	86.0
10	1	1		•											16	28	95.5
12	1	1			•										20	33.5	114.3
14	1	1				•									23	40	136.5
16	1	1					•								26	45	153.5
18	1	2						•							29	50	170.6
20	1	2							•						33	56	191.1
22	1	2								•					36	61.5	209.8
24	1	2									•				39	67	228.6
26	1	2										•			43	73	249.1
28	1	2											•		46	78.5	267.8
30	2	2					•	•							50	85	290.0
32	2	2						••							53	90	307.1
34	2	3				•							•		56	95	324.1
36	2	3					•						•		59	101.5	346.3
38	2	3						•					•		63	106.5	363.4
40	2	3				•								•	64	112	382.1
42	2	3					•							•	64	117.5	400.9
44	2	3						•						•	64	123	419.7
46	2	4										•	•		64	128.5	438.4
48	2	4										•		•	64	134.5	458.9
50	2	4										•		•	64	140	477.7
52	2	4											••		64	146	498.2
54	2	4											•	•	64	151.5	516.9
56	2	4												••	64	157	535.7
58	3	4					•	•						•	64	163.5	557.9
60	3	4						••						•	64	168.5	574.9
62	3	5				•							•	•	64	175	597.1
64	3	5					•						•	•	64	180	614.2
66	3	5						•					•	•	64	185	631.2
68	3	5				•								••	64	191.5	653.4
70	3	5					•							••	64	196.5	670.5
72	3	5						•						••	64	202	689.2
74	3	6											•	•	64	207.5	708.0
76	3	6											•	•	64	213	726.8
78	3	6											•	••	64	218.5	745.5
80	3	6												••	64	224.5	766.0
82	3	6											•	••	64	230	784.8
84	3	6												•••	64	236	803.5
86 ³	4	8								•			•••		64	241.5	820.8
88 ³	4	8											••••		64	246.0	839.6
96 ³	4	8												••••	64	268.0	914.7

Notes:

- The combinations of units shown in the table are factory-recommended. Other combinations of units are also possible.
- For systems with two or more outdoor units, outdoor branch joints (sold separately) are required.
- 86HP, 88HP and 96HP need to be customized.

Dimensions

Body dimension

Unit: in.(mm)

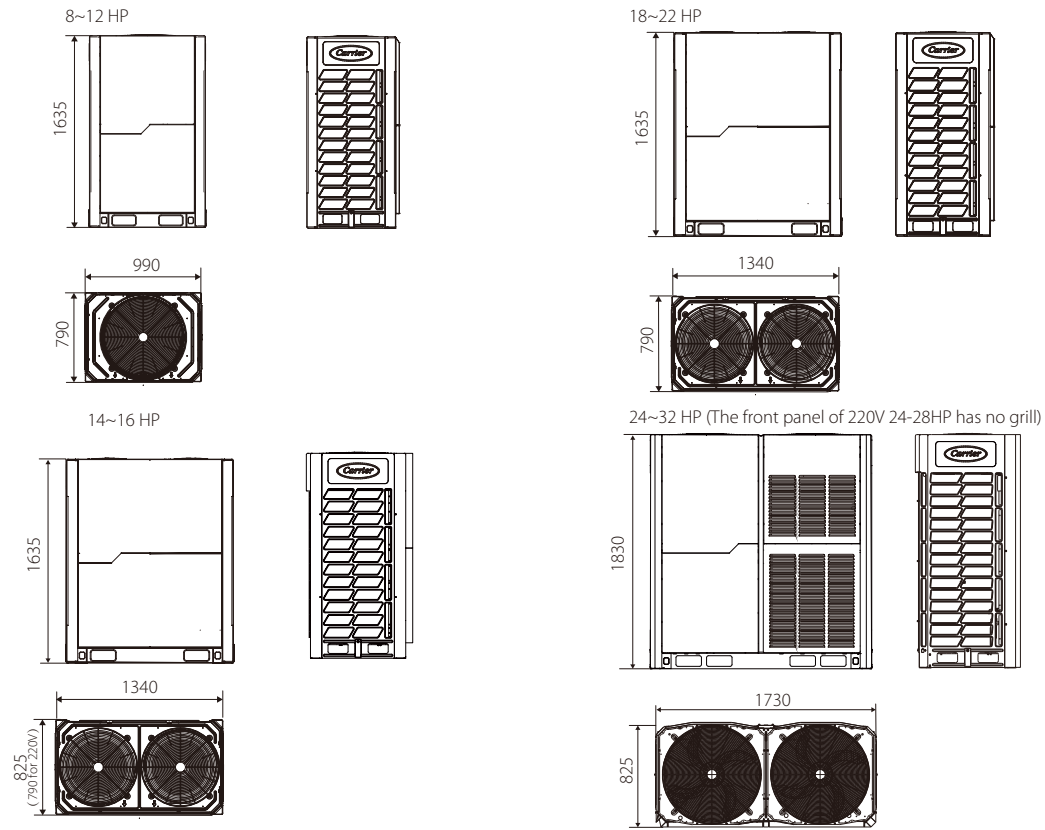

Installation dimension

Unit: in.(mm)

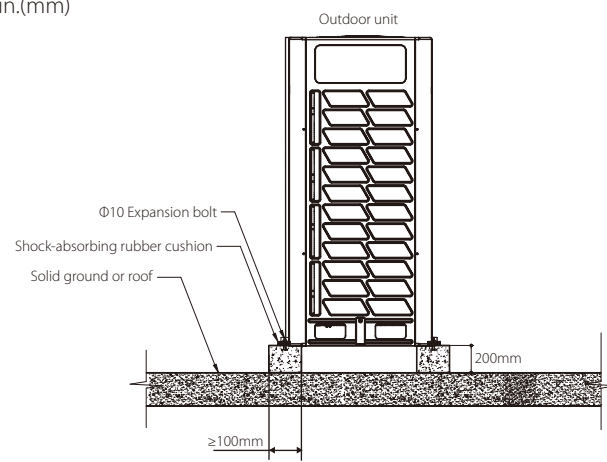

Expansion bolt positioning (Unit: mm)

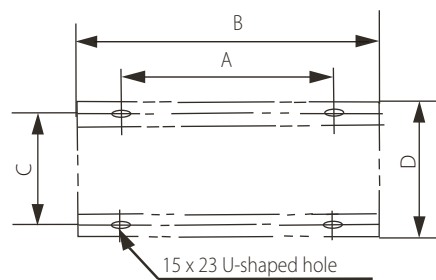

HP	8,10,12	14,16,18,20,22	24,26,28,30,32
SIZE			
A	740	1090	1480
B	990	1340	1730
C	723	723	723
D	790	790	790

Super XC Series Cooling Only VRF



Energy saving

Energy Management System (EMS)

- Floating refrigerant temperature to balance comfort and efficiency
The evaporating temperature is automatically adjusted according to both indoor and outdoor temperature to maximize the comfort and energy efficiency.
- Output limitation during electricity supply restrictions
With the integration of EMS, for projects with temporary electricity supply restrictions, CO VRF can be set to output 40-100% capacity.

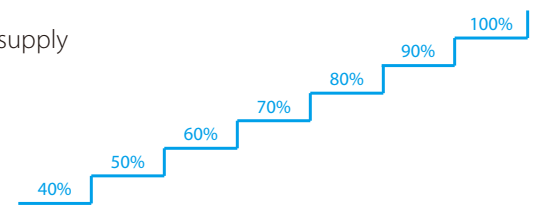
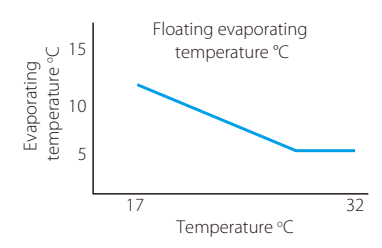

4-side heat exchanger

G-type heat exchangers have higher energy efficiency than the U-type.

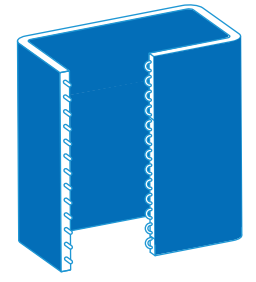

2-rows G-type heat exchanger

High efficiency "2-1" refrigerant flow

The high efficiency "2-1" refrigerant flow increases the proportion of liquid refrigerant in heat exchanger and improve heat exchange efficiency.

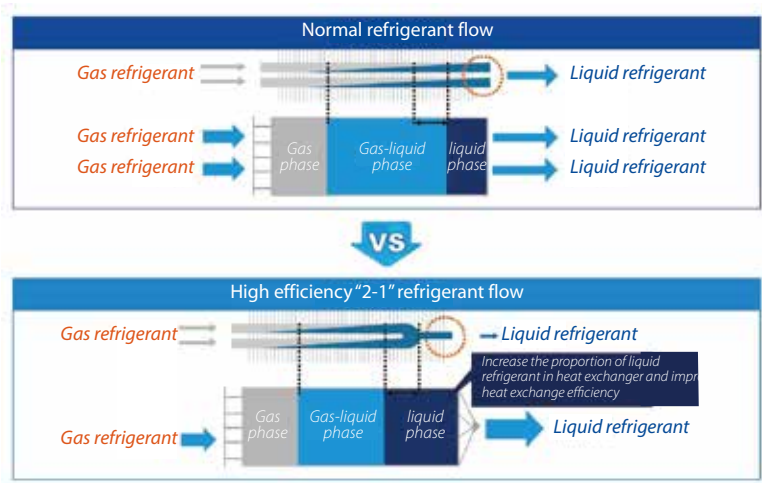

Wide Application Range

Wide Capacity Range

For single unit, the footprint is small and maximum capacity is up to 30HP. For combined units, maximum three 30HP units can be combined with capacity up to 90HP.



Wide Operation Rang

The CO VRF can operate stably in a wide ambient temperature range: from -5°C to 55°C in cooling mode.

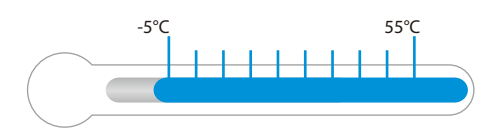

Long Piping Capability

- Total piping length: 1000m
- Longest piping length-actual (equivalent): 175m(200m)
- Longest piping length after first branch: 40/90*m
- Level difference between IDUs and ODU-ODU above (below): 90m (110m)
- Level difference between IDUs: 30m

*The longest length after 1st branch is 40m as standard but can be extended up to 90m under certain conditons. Please contact your local Carrier dealer for further information

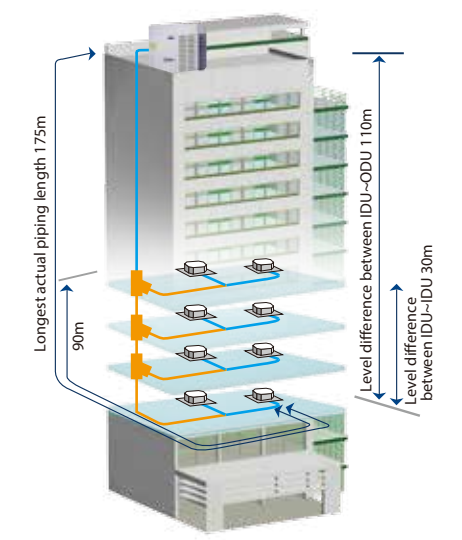

Selectable ESP of outdoor unit*

Selectable external static pressure of outdoor unit: 0Pa, 20Pa, 40Pa, 60 Pa which can meet most of installation requirements.

*This function is available as a customization option.



High Reliability

Real-time Refrigerant Amount Monitoring

The temperature and pressure of refrigerant can be real-time monitored by the outdoor unit. When the level of refrigerant is too low or too high, it can cause damage to the unit and poor performance. CO outdoor unit can detect excessive or insufficient amounts of refrigerant to ensure consistent performance.

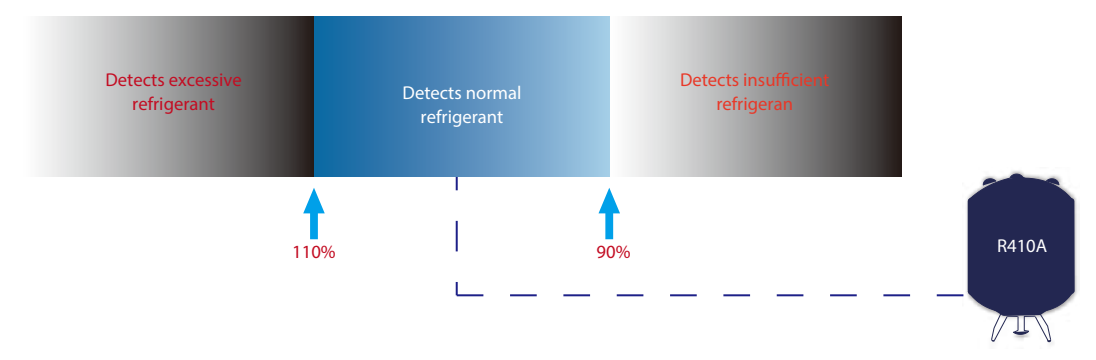

Duty Cycling

Duty cycling equalizes the running time of the outdoor units in a multiple-unit system and of the compressors in each unit, significantly extending compressor lifespan.



In units with two compressors, if one compressor fails, the other compressor can run on its own for up to 4 days, allowing time for maintenance or repair whilst maintaining comfort.

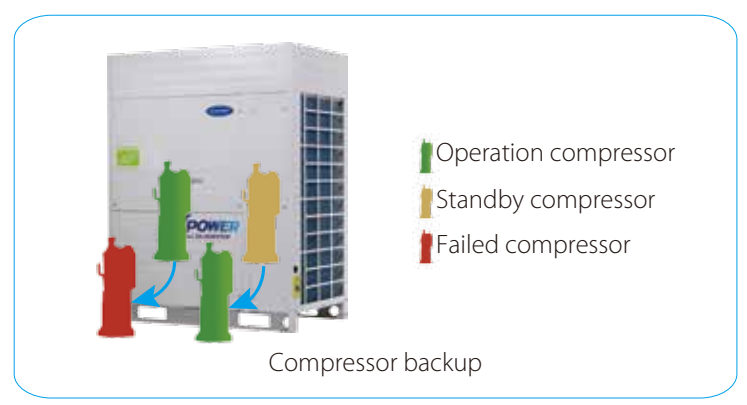

High Reliability

Refrigerant cooling PCB

The CO VRF uses refrigerant cooling technology to cool the electric control box. It decreases the average temperature of electrical control components by about 8 degrees, guaranteeing the stable and safe running of the control system.

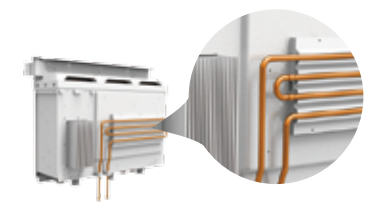

Intelligent Configurations

Intelligent configurations greatly simplify installation, commissioning and servicing.

- Field local configuration achieves quick and easy on-site settings, simplifies installation and commissioning.
- System checking and settings also can be easily achieved via wired controller making the configuration more flexible and convenient.
- A desktop or laptop PC can be used for browser-based access to achieve system configurations through IMMPRO gateway via a LAN connection.



Automatic Refrigerant Charging

Automatic refrigerant charging makes installation and service easier and more efficient.

**This function is available as a customization option.*



Dust-clean function*

The innovatively designed dust-clean function enables the outdoor unit to prevent the dust by itself.

**This function is available as a customization option.*



Enhanced Comfort

Optional silent modes

CO VRF has optional silent modes including night silent mode and non-night silent mode which provides more freedom and convenience to match the customers' needs. Different silent mode is achieved by setting up field settings or through the centralized controller.

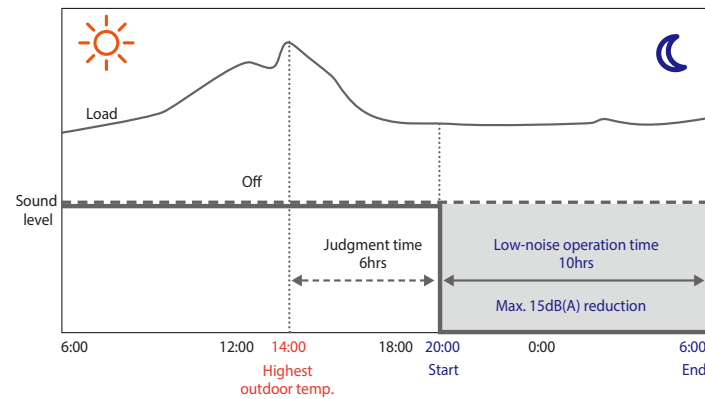

Silent technology features

Several noise reducing components reduce the running noise of outdoor units.



Precise temperature control

CO outdoor unit uses multiple and high precision EXVs to create comfortable indoor environment. The EXV control precision is up to 3000-stage which can precisely control refrigerant flow and guarantee stable indoor temperature. In this way, temperature setting can be adjusted in 0.5°C step, enabling precise comfort control.



Specifications (Super XC 220V)



HP			8	10	12	14	16	18
Model name			38VF008C11B016	38VF010C11B016	38VF012C11B016	38VF014C11B016	38VF016C11B016	38VF018C11B016
Power supply	V/Ph/Hz		220-240V 3Ph 50Hz&208-230V 3Ph 60Hz					
Cooling ¹	Capacity	kW	22.4	28.0	33.5	40.0	45.0	50.0
		kBtu/h	76.5	95.6	114.4	136.6	153.7	170.8
	Power input	kW	5.25	7.10	8.90	10.30	12.00	13.70
	EER		4.27	3.94	3.76	3.88	3.75	3.65
Connected indoor unit	Total capacity	50-130%						
	Maximum quantity		13	16	20	23	26	29
Compressor	Type	DC inverter						
	Quantity		1			1		2
	Oil type	FV 50s						
	Start-up method	Soft start						
Fan	Type	DC						
	Quantity		1			1		2
	Motor output	kW	0.56			0.75		0.56x2
	Static pressure	Pa(in.wg)	20(0.08) default;60(0.24) customization option					
	Airflow rate	m ³ /h(CFM)	10400(6121)		10800(6357)		11600(6828)	
Refrigerant	Type	Direct R410A						
	Factory charge	kg(lbs)	8(17.6)			11(24.3)		13(28.7)
Pipe connections ²	Liquid pipe	mm(inch)	Φ12.7(1/2)			Φ12.7(1/2)		Φ15.9(5/8)
	Gas pipe	mm(inch)	Φ25.4(1)			Φ28.6(1-1/8)		Φ31.8(1-1/4)
Sound pressure level ³		dB(A)	57	58	60	60	61	62
Net dimensions (WxHxD)		mm	960x1615x765			960x1615x765		1250x1615x765
		inch	37-13/16x63-9/16x30-1/8			37-13/16x63-9/16x30-1/8		49-1/4x63-9/16x30-1/8
Packed dimensions (WxHxD)		mm	1025x1790x830			1025x1790x830		1305x1790x820
		inch	40-3/8x70-1/2x32-11/16			40-3/8x70-1/2x32-11/16		51-3/8x70-1/2x32-1/4
Net weight		kg	193			200		296
		lbs	425			441		653
Gross weight		kg	209			216		313
		lbs	461			476		690
Ambient temp.	Cooling	°C(°F)	-5(23) to 55(131)					



HP			20	22	24	26	28	30
Model name			38VF020C11B016	38VF022C11B016	38VF024C11B016	38VF026C11B016	38VF028C11B016	38VF030C11B016
Power supply	V/Ph/Hz		220-240V 3Ph 50Hz&208-230V 3Ph 60Hz					
Cooling ¹	Capacity	kW	56.0	61.5	67.0	73.0	78.5	85.0
		kBtu/h	191.3	210.0	228.8	249.3	268.1	290.3
	Power input	kW	16.50	19.65	20.10	22.20	24.18	27.51
	EER		3.39	3.13	3.33	3.29	3.25	3.09
Connected indoor unit	Total capacity	50-130%						
	Maximum quantity		33	36	39	43	46	50
Compressor	Type	DC inverter						
	Quantity		2			2		2
	Oil type	FV 50s						
	Start-up method	Soft start						
Fan	Type	DC						
	Quantity		2			2		2
	Motor output	kW	0.56x2			0.56x2		0.56x2
	Static pressure	Pa(in.wg)	20(0.08) default;60(0.24) customization option					
	Airflow rate	m ³ /h(CFM)	12200(7181)	12200(7181)	19600(11536)		20600(12125)	
Refrigerant	Type	Direct R410A						
	Factory charge	kg(lbs)	13(28.7)	13(28.7)	19(41.9)		19(41.9)	
Pipe connections ²	Liquid pipe	mm(inch)	Φ15.9(5/8)			Φ19.1(3/4)		Φ19.1(3/4)
	Gas pipe	mm(inch)	Φ31.8(1-1/4)			Φ31.8(1-1/4)		Φ34.9(1-3/8)
Sound pressure level ³		dB(A)	63	63	64		64	
Net dimensions (WxHxD)		mm	1250x1615x765	1250x1615x765	1585x1615x765		1585x1615x765	
		inch	49-1/4x63-9/16x30-1/8	49-1/4x63-9/16x30-1/8	62-3/8x63-9/16x30-1/8		62-3/8x63-9/16x30-1/8	
Packed dimensions (WxHxD)		mm	1305x1790x820	1305x1790x820	1650x1810x840		1650x1810x840	
		inch	51-3/8x70-1/2x32-1/4	51-3/8x70-1/2x32-1/4	64-15/160x71-1/4x33-1/16		64-15/160x71-1/4x33-1/16	
Net weight		kg	296	296	352		352	
		lbs	653	653	776		776	
Gross weight		kg	313	313	376		376	
		lbs	690	690	829		829	
Ambient temp.	Cooling	°C(°F)	-5(23) to 55(131)					

Notes:

1. Indoor temperature 27°C DB, 19°C WB; outdoor temperature 35°C DB; equivalent refrigerant piping length 7.5m with zero level difference.
2. Diameters given are those of the unit's accessories.
3. Sound pressure level is measured at a position 1m in front of the unit and 1.3m above the floor in a semi-anechoic chamber. Product specifications change from time to time as product improvements and developments are released and may vary from those in this document.

Specification (Super XC 380V)



HP	8		10		12	
Model name	38VF008C119016		38VF010C119016		38VF012C119016	
Power supply	V/Ph/Hz		380-415V 3N~ 50/60Hz			
Cooling ¹	Capacity (T1/T3)	kW	22.4/20.56	28.0/25.53	33.5/30.21	
		kBtu/h	76.5/70.2	95.6/87.1	114.4/103.1	
	Power input (T1/T3)	kW	5.17/5.71	6.81/7.48	9.13/9.91	
	EER (T1/T3)		4.33/3.60	4.11/3.41	3.67/3.05	
Connected indoor unit	Total capacity		50-130%			
	Maximum quantity		13	16	20	
Compressor	Type		DC inverter			
	Quantity		1			
Fan	Type		DC			
	Model		ZKSN-560-8-42L			
	Quantity		1			
	Motor output	kW	0.56			
	Max. ESP	Pa	20 default;60 customization option			
	Airflow rate	m ³ /h	10400		10800	
Refrigerant	Type		R410A			
	Factory charge	kg	8			
Pipe connections ²	Liquid pipe	mm	Φ12.7	Φ12.7	Φ15.9	
	Gas pipe	mm	Φ25.4	Φ25.4	Φ28.6	
Sound pressure level ³		dB(A)	57	58	60	
Net dimensions (WxHxD)		mm	960x1615x765			
Packed dimensions (WxHxD)		mm	1025x1790x830			
Net weight		kg	188			
Gross weight		kg	204			
Ambient temp.	Cooling	°C	-5 °C to 55 °C			



HP	14		16		18		20	
Model name	38VF014C119016		38VF016C119016		38VF018C119016		38VF020C119016	
Power supply	V/Ph/Hz		380-415V 3N~ 50/60Hz					
Cooling ¹	Capacity (T1/T3)	kW	40/36.71	45/40.58	50/45.89	56/51.06		
		kBtu/h	136.6/125.3	153.7/138.5	170.8/156.6	191.3/174.3		
	Power input (T1/T3)	kW	10.58/11.69	12.26/13.30	14.88/16.44	17.66/19.39		
	EER (T1/T3)		3.78/3.14	3.67/3.05	3.36/2.79	3.17/2.63		
Connected indoor unit	Total capacity		50-130%					
	Maximum quantity		23	26	29	33		
Compressor	Type		DC inverter					
	Quantity		1		2			
Fan	Type		DC					
	Model		ZKSN-750-8-2		ZKSN-560-8-42L			
	Quantity		1		2			
	Motor output	kW	0.75		0.56x2			
	Max. ESP	Pa	20 default;60 customization option					
	Airflow rate	m ³ /h	11600		12000		12200	
Refrigerant	Type		R410A		R410A			
	Factory charge	kg	11		13			
Pipe connections ²	Liquid pipe	mm	Φ15.9		Φ19.1		Φ22.2	
	Gas pipe	mm	Φ31.8		Φ31.8		Φ31.8	
Sound pressure level ³		dB(A)	60		63			
Net dimensions (WxHxD)		mm	960x1615x765		1250x1615x765			
Packed dimensions (WxHxD)		mm	1025x1790x830		1305x1790x820			
Net weight		kg	197		278			
Gross weight		kg	213		297			
Ambient temp.	Cooling	°C	-5 °C to 55 °C					

Notes:

- T1 Cooling: Indoor temperature 27°CDB/19°C WB; Outdoor temperature 35°C DB/24°C WB;
T3 Cooling: Indoor temperature 29°C DB/19°C WB; Outdoor temperature 46°C DB/24°C WB;
Piping length: Interconnecting piping length is 7.5m, level difference is zero.
- Diameters given are those of the unit's accessories.
- Sound pressure level is measured at a position 1m in front of the unit and 1.3m above the floor in a semi-anechoic chamber.

Specification (Super XC 380V)



HP	22		24		26	
Model name	38VF022C119016		38VF024C119016		38VF026C119016	
Power supply	V/Ph/Hz		380-415V 3N~ 50/60Hz			
Cooling ¹	Capacity (T1/T3)	kW	61.5/55.46	67/61.49	73/66.56	
		kBtu/h	210.0/189.3	228.8/209.9	249.3/227.2	
	Power input (T1/T3)	kW	20.23/21.96	20.68/22.85	23.4/25.69	
	EER (T1/T3)		3.04/2.53	3.24/2.69	3.12/2.59	
Connected indoor unit	Total capacity		50-130%		50-130%	
	Maximum quantity		36	39	43	
Compressor	Type		DC inverter			
	Quantity		2			
Fan	Type		DC			
	Model		ZKSN-560-8-42L			
	Quantity		2			
	Motor output	kW	0.56x2			
	Max. ESP	Pa	20 default;60 customization option			
	Airflow rate	m ³ /h	12200		19600	
Refrigerant	Type		R410A			
	Factory charge	kg	13		19	
Pipe connections ²	Liquid pipe	mm	Φ19.1		Φ22.2	
	Gas pipe	mm	Φ31.8		Φ31.8	
Sound pressure level ³		dB(A)	63		64	
Net dimensions (WxHxD)		mm	1250x1615x765		1585x1615x765	
Packed dimensions (WxHxD)		mm	1305x1790x820		1650x1810x840	
Net weight		kg	278		338	
Gross weight		kg	297		362	
Ambient temp.	Cooling	°C	-5 °C to 55 °C			



HP	28		30	
Model name	38VF028C119016		38VF030C119016	
Power supply	V/Ph/Hz		380-415V 3N~ 50/60Hz	
Cooling ¹	Capacity (T1/T3)	kW	78.5/70.79	85/76.65
		kBtu/h	268.1/241.6	290.3/261.6
	Power input (T1/T3)	kW	26.08/28.3	29.51/32.02
	EER (T1/T3)		3.01/2.50	2.88/2.39
Connected indoor unit	Total capacity		50-130%	
	Maximum quantity		46	
Compressor	Type		DC inverter	
	Quantity		2	
Fan	Type		DC	
	Model		ZKSN-560-8-42L	
	Quantity		2	
	Motor output	kW	0.56x2	
	Max. ESP	Pa	20 default;60 customization option	
	Airflow rate	m ³ /h	20600	
Refrigerant	Type		R410A	
	Factory charge	kg	19	
Pipe connections ²	Liquid pipe	mm	Φ22.2	
	Gas pipe	mm	Φ31.8	Φ38.1
Sound pressure level ³		dB(A)	64	
Net dimensions (WxHxD)		mm	1585x1615x765	
Packed dimensions (WxHxD)		mm	1650x1810x840	
Net weight		kg	338	
Gross weight		kg	362	
Ambient temp.	Cooling	°C	-5 °C to 55 °C	

Notes:

- T1 Cooling: Indoor temperature 27°CDB/19°C WB; Outdoor temperature 35°C DB/24°C WB;
T3 Cooling: Indoor temperature 29°C DB/19°C WB; Outdoor temperature 46°C DB/24°C WB;
Piping length: Interconnecting piping length is 7.5m, level difference is zero.
- Diameters given are those of the unit's accessories.
- Sound pressure level is measured at a position 1m in front of the unit and 1.3m above the floor in a semi-anechoic chamber.

Outdoor unit combinations

System capacity		Number of units	Modules ¹												Outdoor branch joint kit ²			
kW	HP		8	10	12	14	16	18	20	22	24	26	28	30				
22.4	8	1	●															
28.0	10	1		●														
33.5	12	1			●													
40.0	14	1				●												
45.0	16	1					●											
50.0	18	1						●										
56.0	20	1							●									
61.5	22	1								●								
67.0	24	1									●							
73.0	26	1										●						
78.5	28	1											●					
85.0	30	1												●				
90.0	32	2						●	●									
95.0	34	2			●					●								
101.0	36	2						●			●							
106.5	38	2							●			●						
112.0	40	2									●							
118.0	42	2										●						
123.5	44	2											●					
130.0	46	2												●				
134.5	48	2													●			
140.0	50	2														●		
146.5	52	2															●	
151.5	54	2																●
157.0	56	2															●	●
163.5	58	2																●
170.0	60	2																●
175.0	62	3																●
179.5	64	3																●
185.0	66	3																●
191.5	68	3																●
196.5	70	3																●
202.0	72	3																●
208.5	74	3																●
215.0	76	3																●
218.5	78	3																●
225.0	80	3																●
231.5	82	3																●
235.5	84	3																●
242.0	86	3																●
248.5	88	3																●
255.0	90	3																●

Notes:
 1.The combinations of units shown in the table are factory-recommended. Other combinations of units are also possible.
 2.For systems with two or more outdoor units, outdoor branch joints (sold separately) are required.

Dimensional Drawing (mm)

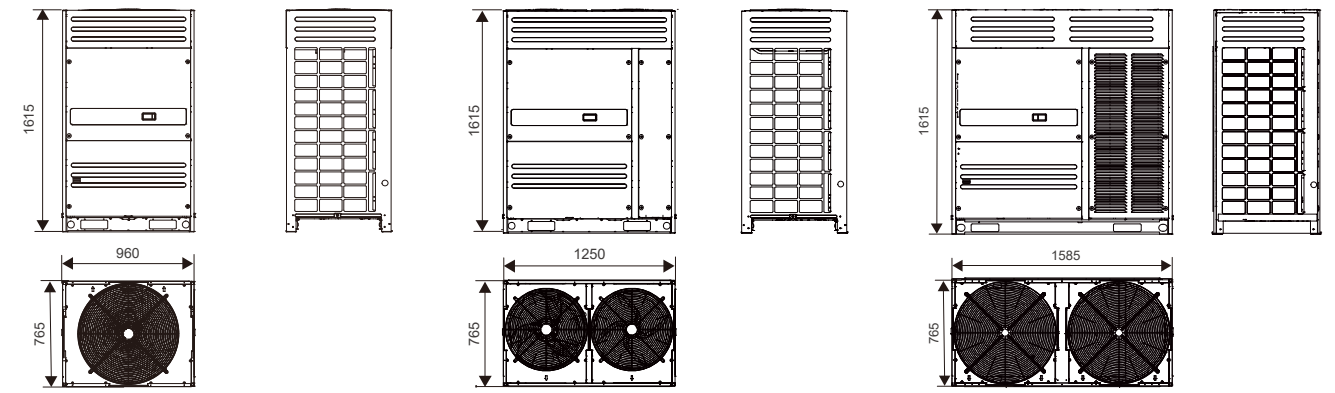

8-16HP

18-22HP

24-30HP

Single Unit installation (mm)

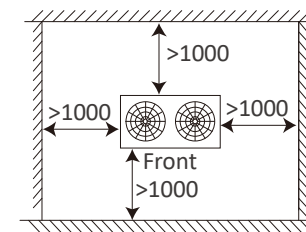

Single Row Installation

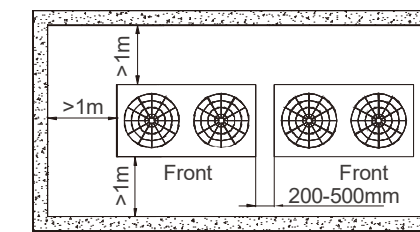

Multi-Row Installation

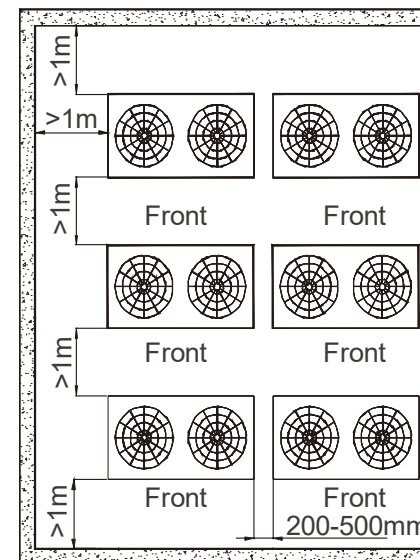

Outdoor unit typical concrete base structure design

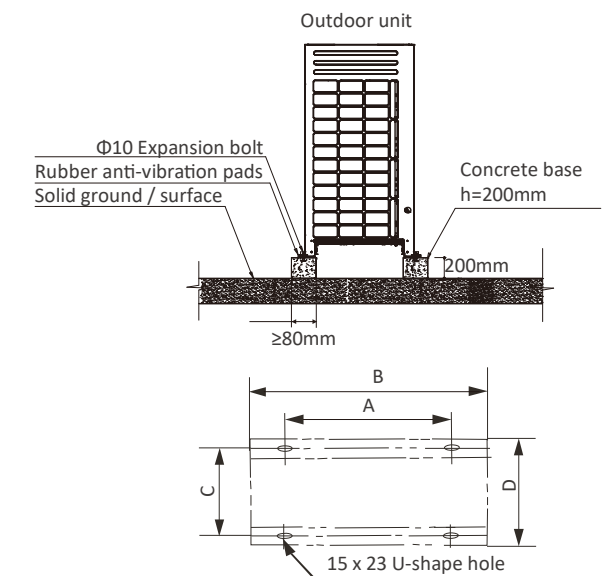

Dimension(mm)	8-16HP	18-22HP	24-30HP
A	830	1120	1455
B	960	1250	1585
C	736	736	736
D	765	765	765

Super Plus Series Heat Pump VRF



High Efficiency

High EER and COP

DC compressors and fan motors together with a high-efficiency heat exchanger combine to give the Super Plus Series top-class energy efficiency in cooling and heating.

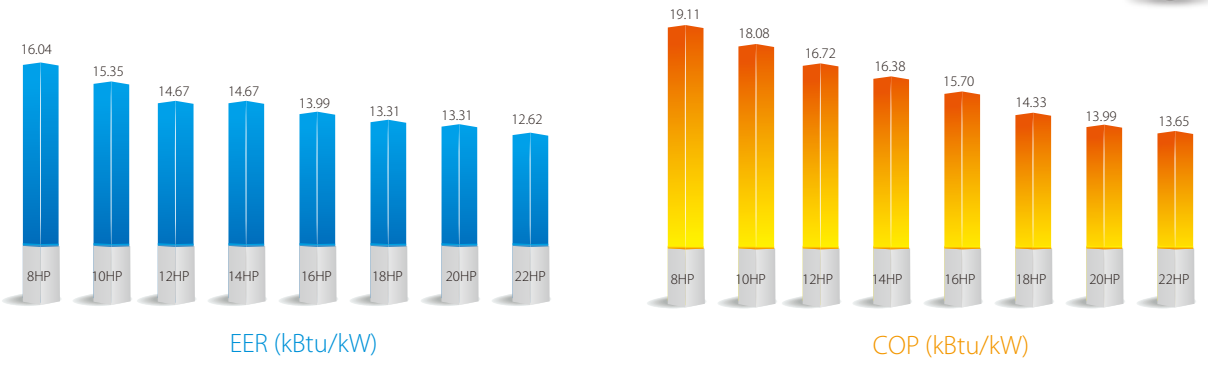

All DC Inverter Compressors

At the heart of the Super Plus Series outdoor unit lies a world-leading DC inverter scroll compressor. The compressor's innovative design and numerous high performance features reduce power consumption by 25%.



All DC Fan Motors

Fan speed is controlled according to the system pressure and system load, minimizing energy consumption.

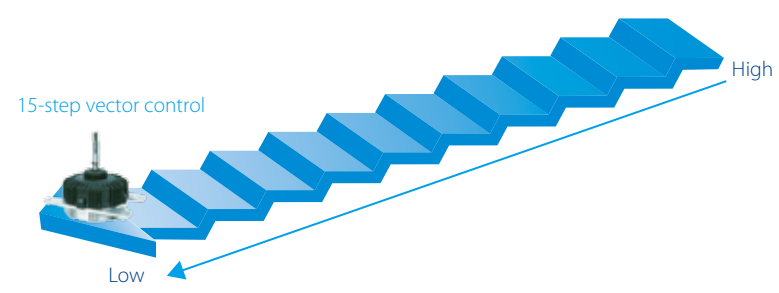

High Efficiency Heat Exchanger

Newly designed fins enlarge the heat exchange area and decrease air resistance, enhance heat exchange performance and save more energy. Hydrophilic fins and internally threaded copper pipes optimize heat exchange efficiency. δ design increases the degree of liquefaction in the condenser and improves heat-exchange efficiency.

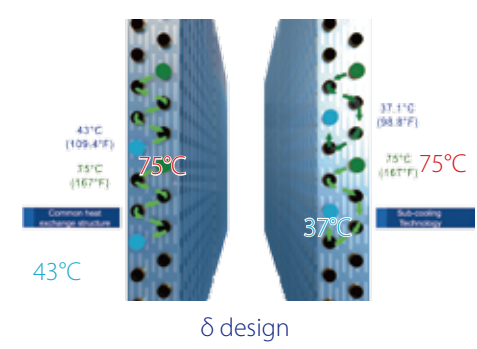
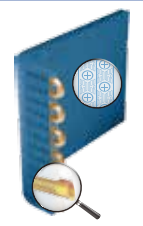

Newly Designed Fan

A new blade with sharp edges and a slight curve increases the airflow rate and lowers vibration and airflow resistance.

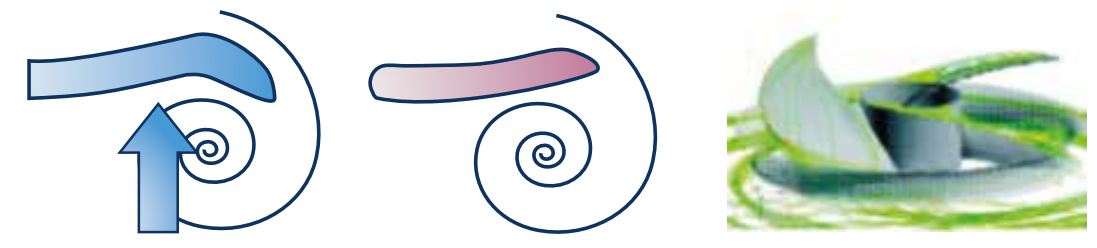

Precise Control

Multiple solenoid valves ensure precise temperature control, stable and efficient operation, and improved comfort.

Dual EXVs Control

Dual EXVs in one system, each EXV part achieves 480 Pulse rate to precisely adjust refrigerant flow.

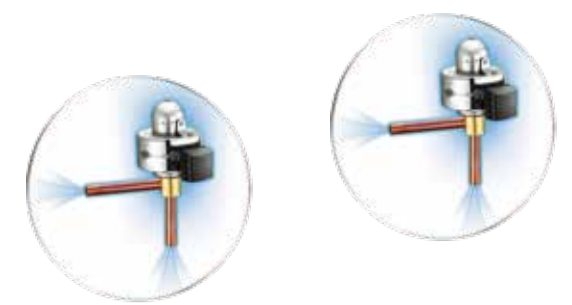

Wide Application Range

Wide Capacity Range

The Super Plus series has an extensive range of capacities, from 8HP to 88HP(max.72HP for tropical model combination), meeting all customer requirements from small to large buildings.



Wide Range of Indoor Units

Carrier provides 12 types and more than 100 models of VRF indoor units to meet varied customer requirements in a wide range of locations including shopping malls, hospitals, office buildings, hotels and airports.

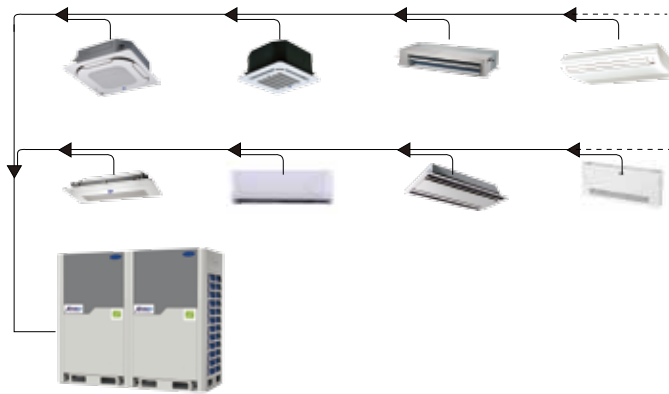

Wide Operation Range

Super Plus Series operates stably under extreme conditions, ranging from minus 20° C to 48° C. (-20° C to 54° C for tropical model).

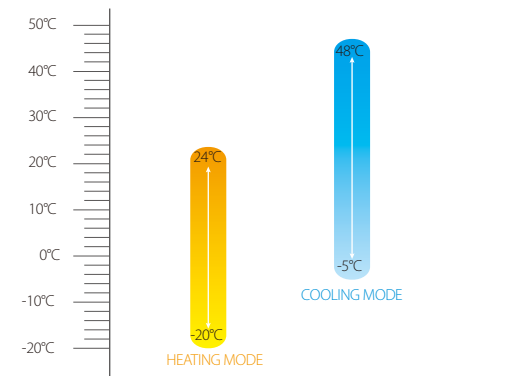

Long Piping Capability

Piping length	Capability
Total piping length	1000m
Longest length - actual (equivalent)	175m (200m)
Longest length after first branch	90m*
Largest height difference between indoor and outdoor units - ODU up (down)	90m (110m)
Largest height difference between indoor units	30m

*The longest length after first branch is 40m as standard but can be extended to up to 90m under certain conditions. Please contact your local Carrier sales companies for further information.

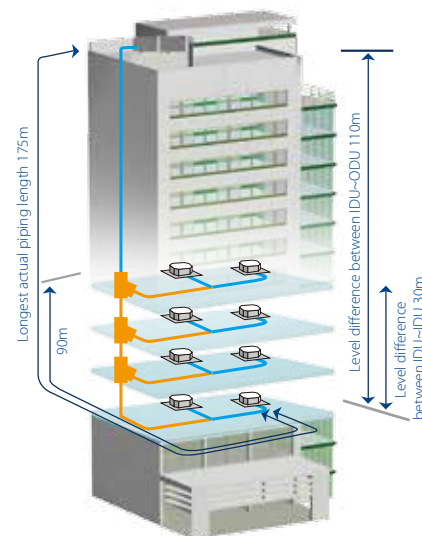

High Reliability

Duty Cycling

Duty cycling equalizes the running time of the outdoor units in a multiple-unit system and of the compressors in each unit, significantly extending compressor lifespan.



Backup

In a multi-unit system, if one module fails, the other modules provide backup so that the system can continue operating.



Precise Oil Control Technology

Five stages of oil control technology ensure all outdoor compressor oil is always kept at a safe level, eliminating any compressor oil shortage problems.

- The 1st stage:** Compressor internal oil separation.
- The 2nd stage:** High-efficiency centrifugal oil separator (with separation efficiency of up to 99%) ensures that oil is separated from the discharge gas and returned to the compressors in a timely fashion.
- The 3rd stage:** Oil balance pipes between compressors ensure even oil distribution to keep compressors running normally.
- The 4th stage:** Oil balance pipes among modules ensure even oil distribution among modules.
- The 5th stage:** Auto oil return program monitors the running time and system status to ensure reliable oil return.

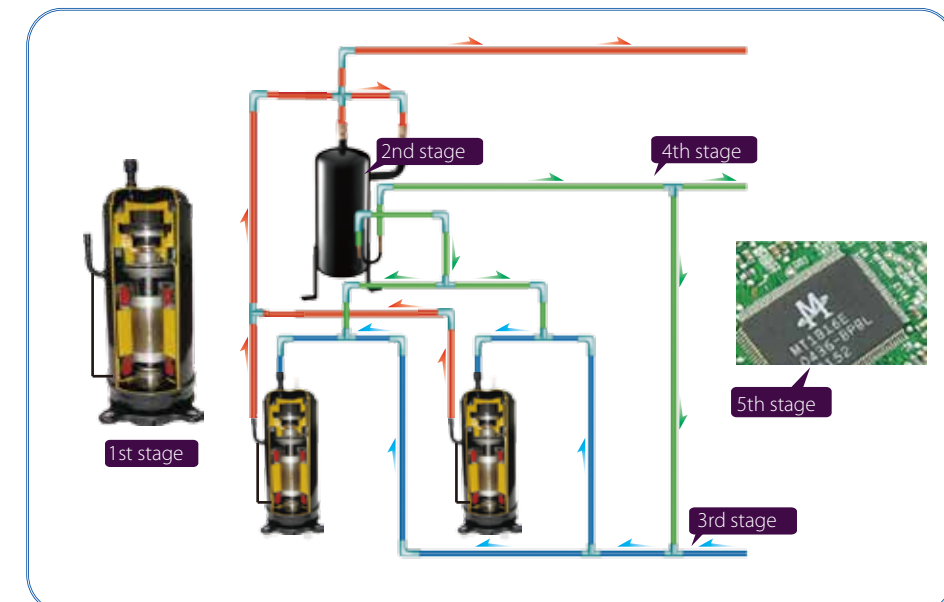

Enhanced Comfort

Night Silent Mode

The night silent mode feature, which is easily configured on the outdoor unit's PCB, includes various scheduling options that can be used to reduce noise levels at times when low noise operation is required.



Intelligent Defrosting Technology

The intelligent defrosting program calculates the time required for defrosting according to the actual system status, eliminating heat losses from unnecessary defrosting. A specialized defrosting valve reduces time required for defrosting to as little as four minutes.

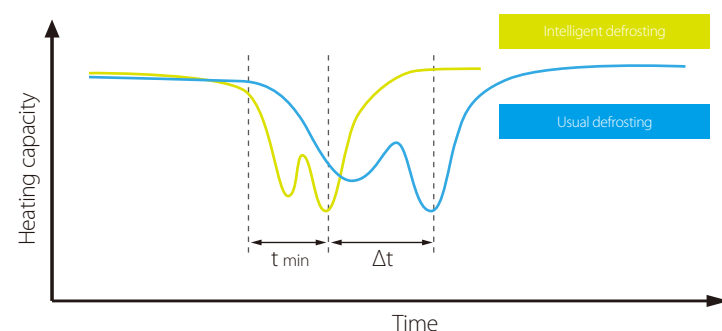

Rapid Cooling or Heating

The DC inverter compressor reaches full capacity rapidly, providing quicker cooling or heating with lower levels of temperature fluctuation during the cooling/heating operation.

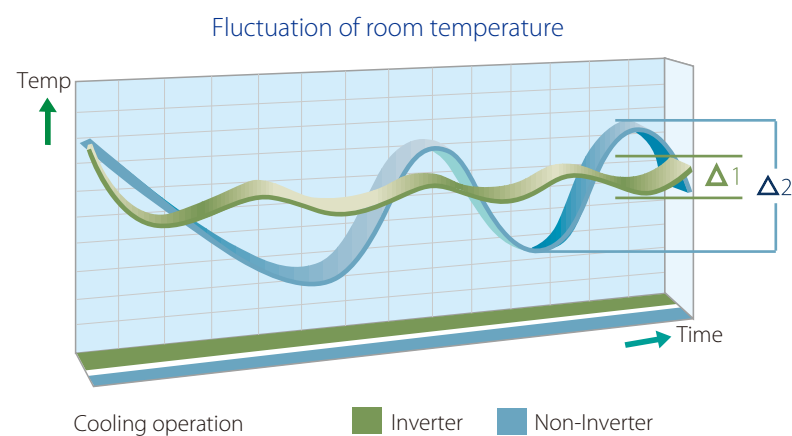

Anti-corrosion Protection

Outdoor units are given anti-corrosion treatment for non-extreme conditions as standard and can also be customized with heavy anti-corrosion treatment on steel sheets, grills, coil fins, electric control box case and screws/bolts for surface protection against corrosive air, acid rain and saline air (for installations in coastal regions) to extend overall useful life.

The integrity of the anti-corrosion treatment is ensured by subjecting major components and parts to salt mist testing, moisture and heating testing and light aging testing.



Heat Exchanger Aluminum Foil

Standard products:
72h of neutral salt mist

Heavy anti-corrosion products:
1000h of neutral salt mist
140h of acid salt mist

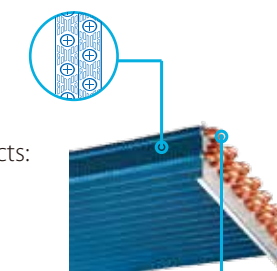

Motor

Standard products:
72h of neutral salt mist

Heavy anti-corrosion products:
240h of neutral salt mist



Copper

Standard products:
24h of neutral salt mist

Heavy anti-corrosion products:
120h of neutral salt mist



Painted Sheet Metal

Standard products:
500h of neutral salt mist
1000h of moisture and heating test
500h of light aging test

Heavy anti-corrosion products:
1000h of neutral salt mist
2000h of moisture and heating test
720h of light aging test



Electric Control Box Case

Standard products:
96h of neutral salt mist

Heavy anti-corrosion products:
240h of neutral salt mist



Screws / Bolts / Gaskets

Standard products:
300h of neutral salt mist

Heavy anti-corrosion products:
720h of neutral salt mist



Compressor / Motor Bolts

Standard products:
72h of neutral salt mist

Heavy anti-corrosion products:
168h of neutral salt mist

Specifications (Super Plus)



8-12HP

Model name		38VF008H117015 38VF008H116015 38VF008H119015	38VF010H117015 38VF010H116015 38VF010H119015	38VF012H117015 38VF012H116015 38VF012H119015	38VF014H117015 38VF014H116015 38VF014H119015	
Power supply		220V/3/60Hz 460/3/60 380-415V/3/50(60)Hz				
Cooling	Capacity	kW	25.2	28.0	33.5	40.0
		kBtu/h	86.0	95.6	114.3	136.5
	Power input	kW	5.36	6.22	7.79	9.30
	EER	KBtu/h/kW	16.04	15.35	14.67	14.67
	IPLV	KBtu/h/kW	27.30	27.80	26.61	26.27
Heating	Capacity	kW	27.0	31.5	37.5	45.0
		kBtu/h	92.1	107.5	128.0	153.6
	Power input	kW	4.82	5.94	7.65	9.38
	COP	KBtu/h/kW	19.11	18.08	16.72	16.38
Connectable indoor unit	Total capacity	50~130% of outdoor unit capacity				
	Max. quantity	13	16	20	23	
Compressor	Type	DC inverter				
	Quantity	1	1	1	2	
	Crankcase heater	W	27.6x2	27.6x2	27.6x2	27.6x4
	Refrigerant oil type	FVC68D				
	Refrigerant oil charge	ml	500	500	500	500x2
Fan motor	Type	DC motor				
	Quantity	1	1	1	2	
	Insulation class	E				
	Safe class	IP23				
	Static pressure	Pa	0-20 (default)			
Pa		20-60 (customized)				
Fan	Material	Plastic				
	Type	Axial				
	Quantity	1	1	1	2	
Outdoor coil	Number of rows	2	2	3	2	
	Fin type	Hydrophilic aluminum				
	Tube OD	mm	Φ7.94			
	Tube type	Inner-grooved				
	Number of circuits	22				
Refrigerant	Type	R410A				
	Factory charging	kg	9	9	11	13
Pipe connection	Liquid pipe	mm	Φ12.7	Φ12.7	Φ15.9	Φ15.9
	Gas pipe	mm	Φ25.4	Φ25.4	Φ28.6	Φ31.8
	Oil balance pipe	mm	Φ8			
Design pressure(High/low)	MPa	4.4/2.6				
	PSI	640/380				
Air flow rate	m ³ /h	12000	12000	12000	14000	
Sound pressure level	dB(A)	58	59	60	62	
Net dimension (WxHxD)	mm	990x1635x790			1340x1635x790	
Packing size (WxHxD)	mm	1090x1805x860			1405x1805x855	
Net weight (460V)	kg	326	334	369	369	
Gross weight (460V)	kg	353	361	396	396	
Operating temperature range	°C	Cooling: -5~48; Heating: -20~24				

Notes:

- Indoor temperature 27°C DB, 19°C WB; outdoor temperature 35°C DB; equivalent refrigerant piping length 7.5m with zero level difference.
- Indoor temperature 20°C DB; outdoor temperature 7°C DB, 6°C WB; equivalent refrigerant piping length 7.5m with zero level difference.
- Diameters given are those of the unit's stop valve.
- Sound pressure level is measured at a position 1m in front of the unit and 1.3m above the floor in a semi-anechoic chamber.
- The data in this catalogue may be changed without notice for further improvement on quality and performance.
- IPLV are complied with GB 21454 - 2008.

Specifications (Super Plus)



14-22HP

Model name		38VF016H117015 38VF016H116015 38VF016H119015	38VF018H117015 38VF018H116015 38VF018H119015	38VF020H117015 38VF020H116015 38VF020H119015	38VF022H117015 38VF022H116015 38VF022H119015	
Power supply		220V/3/60Hz 460V/3/60 380-415V/3/50(60)Hz				
Cooling	Capacity	kW	45.0	50.0	56.0	61.5
		kBtu/h	153.6	170.6	191.1	209.9
	Power input	kW	10.98	12.82	14.51	16.44
	EER	KBtu/h/kW	13.99	13.31	13.31	12.62
	IPLV	KBtu/h/kW	25.93	25.93	25.59	25.25
Heating	Capacity	kW	50.0	56.0	63.0	69.0
		kBtu/h	170.6	191.1	215.0	235.5
	Power input	kW	10.87	13.18	15.29	17.12
	COP	KBtu/h/kW	15.70	14.33	13.99	13.65
Connectable indoor unit	Total capacity	50~130% of outdoor unit capacity				
	Max. quantity	26	29	33	36	
Compressor	Type	DC inverter				
	Quantity	2				
	Crankcase heater	W	27.6x4			
	Refrigerant oil type	FVC68D				
	Refrigerant oil charge	ml	500x2			
Fan motor	Type	DC motor				
	Quantity	2				
	Insulation class	E				
	Safe class	IP23				
	Static pressure	Pa	0-20 (default)			
Pa		20-60 (customized)				
Fan	Material	Plastic				
	Type	Axial				
	Quantity	2				
Outdoor coil	Number of rows	2	2	3	3	
	Fin type	Hydrophilic aluminum				
	Tube OD	mm	Φ7.94			
	Tube type	Inner-grooved				
	Number of circuits	22				
Refrigerant	Type	R410A				
	Factory charging	kg	13	13	16	16
Pipe connection	Liquid pipe	mm	Φ15.9	Φ19.1	Φ19.1	Φ19.1
	Gas pipe	mm	Φ31.8	Φ31.8	Φ31.8	Φ31.8
	Oil balance pipe	mm	Φ8			
Design pressure(High/low)	MPa	4.4/2.6				
	PSI	640/380				
Air flow rate	m ³ /h	14000	16000	16000	16000	
Sound pressure level	dB(A)	62	63	63	63	
Net dimension (WxHxD)	mm	1340x1635x790				
Packing size (WxHxD)	mm	1405x1805x855				
Net weight (460V)	kg	326	334	369	369	
Gross weight (460V)	kg	353	361	396	396	
Operating temperature range	°C	Cooling: -5~48; Heating: -20~24				

Notes:

- Indoor temperature 27°C DB, 19°C WB; outdoor temperature 35°C DB; equivalent refrigerant piping length 7.5m with zero level difference.
- Indoor temperature 20°C DB; outdoor temperature 7°C DB, 6°C WB; equivalent refrigerant piping length 7.5m with zero level difference.
- Diameters given are those of the unit's stop valve.
- Sound pressure level is measured at a position 1m in front of the unit and 1.3m above the floor in a semi-anechoic chamber.
- The data in this catalogue may be changed without notice for further improvement on quality and performance.
- IPLV are complied with GB 21454 - 2008.

Recommended combination table

Model	No. of Outdoor Units	No. of Compressors	Outdoor Unit Combination								Max No. of Connectable Indoor Unit	Capacity			
			8	10	12	14	16	18	20	22		Cooling		Heating	
												kW	kBtu/h	kW	kBtu/h
8	1	1	•								13	25.2	86.0	27	92.1
10	1	1		•							16	28	95.5	31.5	107.5
12	1	1			•						20	33.5	114.3	37.5	128.0
14	1	2				•					23	40	136.5	45	153.5
16	1	2					•				26	45	153.5	50	170.6
18	1	2						•			29	50	170.6	56	191.1
20	1	2							•		33	56	191.1	63	215.0
22	1	2								•	36	61.5	209.8	69	235.4
24	2	2			••						39	67	228.6	75	255.9
26	2	3		•			•				43	73	249.1	81.5	278.1
28	2	3		•				•			46	78	266.1	87.5	298.6
30	2	3		•					•		50	84	286.6	94.5	322.4
32	2	3		•						•	53	89.5	305.4	100.5	342.9
34	2	3			•					•	56	95	324.1	106.5	363.4
36	2	4						••			59	100	341.2	112	382.1
38	2	4					•		•		63	106.5	363.4	119	406.0
40	2	4						•	•		64	111.5	380.4	125	426.5
42	2	4							•	•	64	117.5	400.9	132	450.4
44	2	4								••	64	123	419.7	138	470.9
46	3	4			••					•	64	128.5	438.4	144	491.3
48	3	5		•			•			•	64	134.5	458.9	150.5	513.5
50	3	5		•				•		•	64	139.5	476.0	156.5	534.0
52	3	5		•					•	•	64	145.5	496.4	163.5	557.9
54	3	5		•						••	64	151	515.2	169.5	578.3
56	3	5			•					••	64	156.5	534.0	175.5	598.8
58	3	6						••		•	64	161.5	551.0	181	617.6
60	3	6					•			••	64	168	573.2	188	641.5
62	3	6						•		••	64	173	590.3	194	661.9
64	3	6							•	••	64	179	610.7	201	685.8
66	3	6								•••	64	184.5	629.5	207	706.3
68	4	6			••					••	64	190	648.3	213	726.8
70	4	7		•			•			••	64	196	668.8	219.5	748.9
72	4	7		•				•		••	64	201	685.8	225.5	769.4
74	4	7		•					•	••	64	207	706.3	232.5	793.3
76	4	7		•						•••	64	212.5	725.1	238.5	813.8
78	4	7			•					•••	64	218	743.8	244.5	834.2
80	4	8						••		••	64	223	760.9	250	853.0
82	4	8					•			•••	64	229.5	783.1	257	876.9
84	4	8						•		•••	64	234.5	800.1	263	897.4
86	4	8							•	•••	64	240.5	820.6	270	921.2
88	4	8								••••	64	246	839.4	276	941.7

Notes:

Capacities are based on the following conditions:

Cooling: Indoor temperature 27°C DB/19°C WB; Outdoor temperature 35°C DB/24°C WB

Heating: Indoor temperature 20°C DB/15°C WB; Outdoor temperature 7°C DB/6°C WB

Piping length: Interconnecting piping length is 7.5m, level difference is zero.

The above combination models are factory-recommended models

Dimensions

Body dimension

Unit: in.(mm)

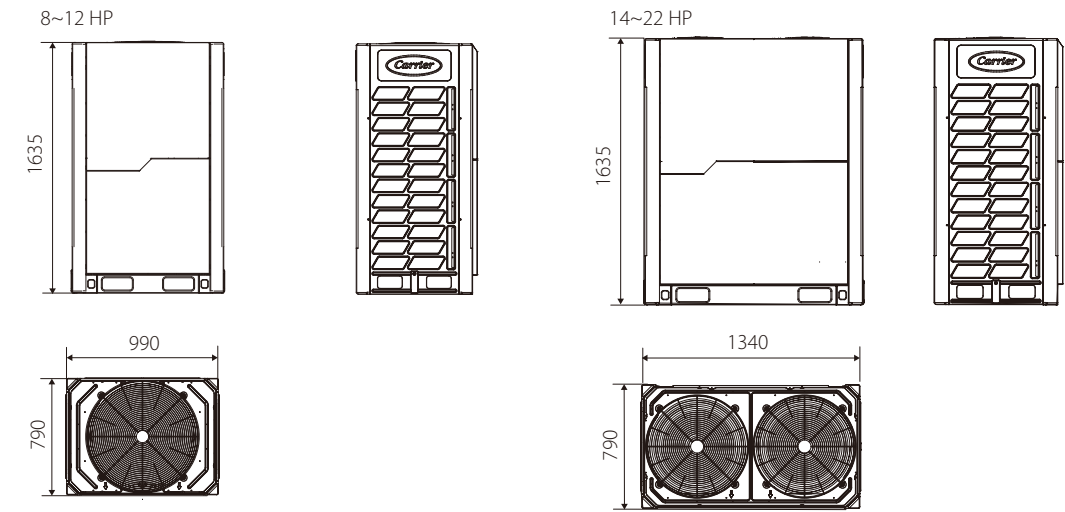

Installation dimension

Unit: in.(mm)

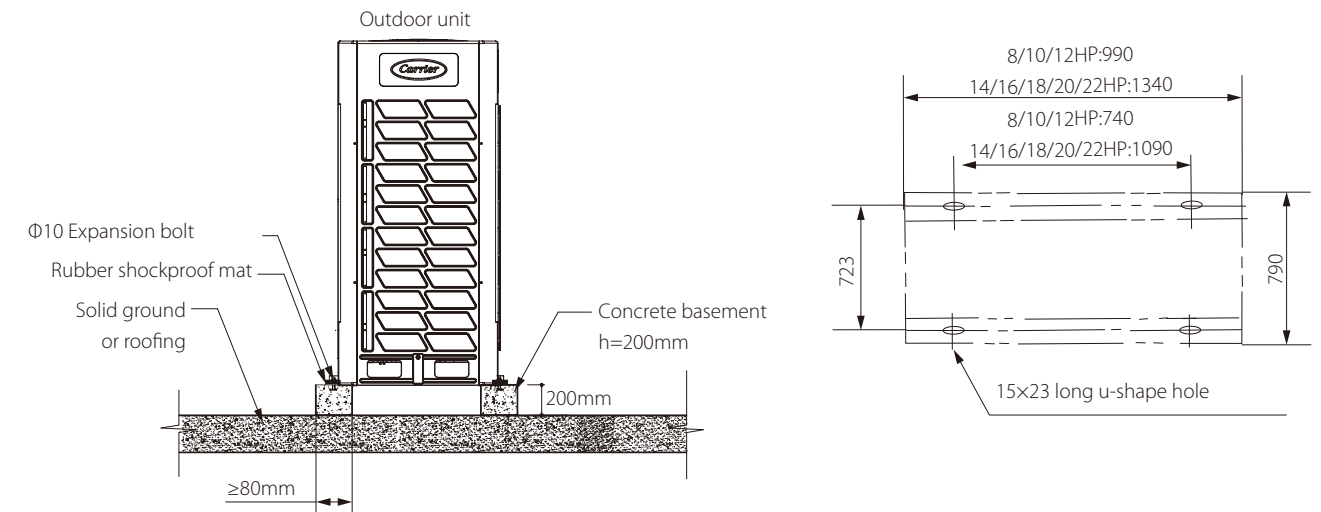

Super XR Series Heat Recovery VRF



Wide Capacity Range

Starting at 8HP, capacity increases in 2HP increments up to 54HP, which is perfect for small to large buildings.



Wide Operation Range

The Super XR VRF system has a wide operation range in cooling mode, heating mode and simultaneous cooling and heating mode.

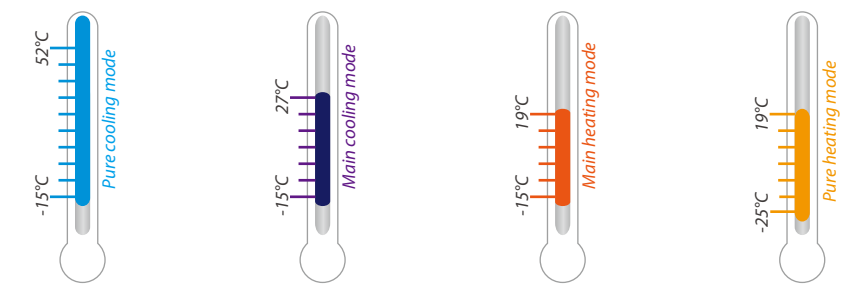

Long Piping Capability

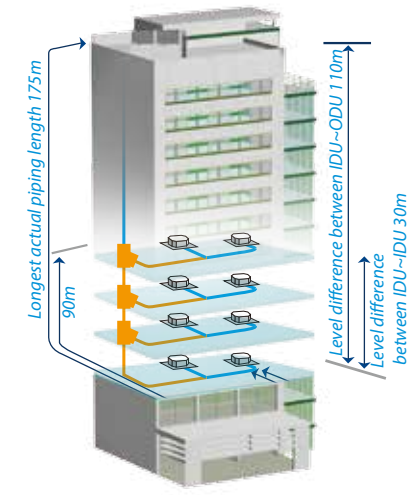

Piping length	Capability
Total piping length	1000m
Longest length - actual (equivalent)	175m (200m)
Longest piping length after first branch	40/90m*
Longest piping between MS and IDU	40m
Level difference between IDUs and ODU - ODU above (below)	110m (110m)
Level difference between IDUs	30m

*The longest length after first branch is 40m as standard but can be extended to up to 90m under certain conditions.

Heat Recovery, Maximum Energy Saving

Super XR Heat Recovery system can perform both cooling and heating operation simultaneously in one system. Heat recovery is achieved by diverting exhaust heat from indoor units in cooling mode to areas requiring heating. As a result of this, energy efficiency is maximized and electricity costs are reduced. The part load efficiencies are high as well (up to 7.8 in 8 HP category).

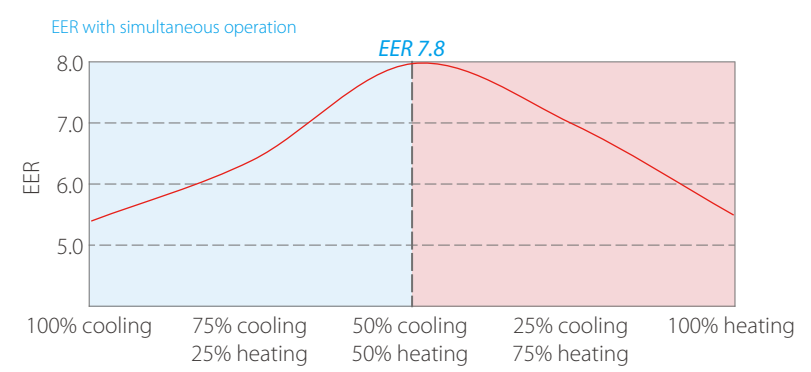

EER in simultaneous cooling and heating mode are based on the following condition: Outdoor temperature 7°CDB/6°CWB, indoor temperature 27°CDB/19°CWB for cooling, indoor temperature 20°CDB for heating.

Hot Water Supply

The Super XR system can also produce domestic hot water (25°C to 80°C) when providing room air conditioning. The domestic hot water can be used for underfloor heating and domestic hot water, improving room comfort.

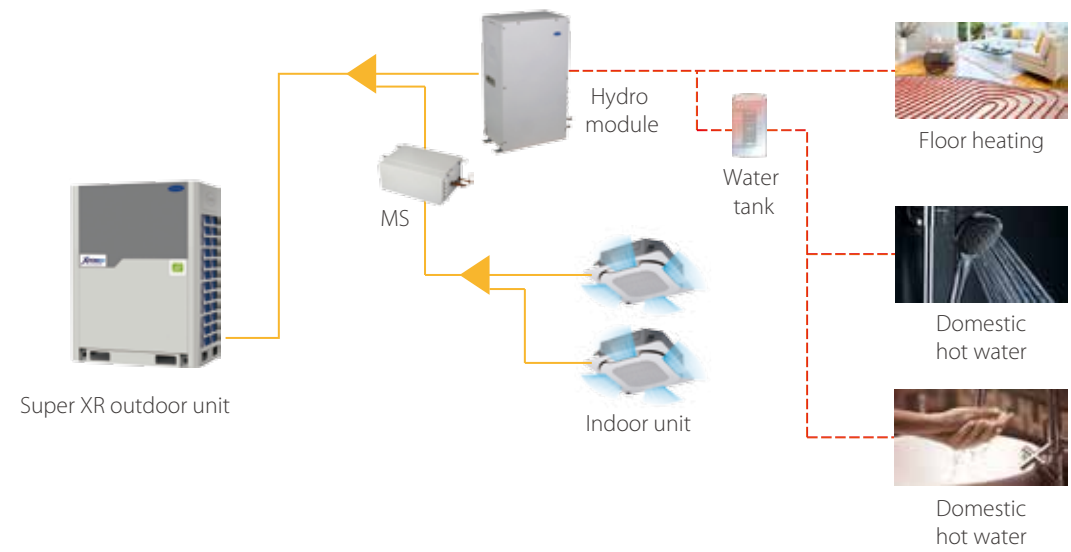

Continuous Heating During Defrost Mode

Normally, it is necessary to stop the heating operation during defrosting. However, the continuous heating operation method makes it possible to perform defrosting while the heating operation continues. With the combination model, units perform defrosting alternately. While one unit is performing defrosting, the other continues heating.

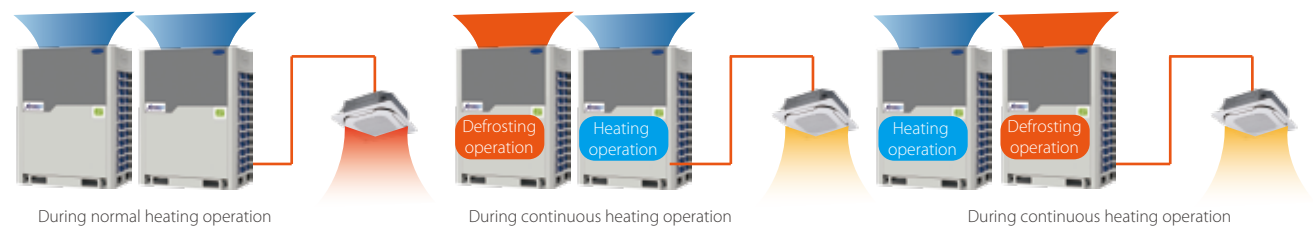

Note: This function is only available when the indoor units connected in V6R system are 2nd generation AC VRF indoor units (which will be released soon) or 2nd generation DC VRF indoor units produced after May 31st, 2020 only.

Independent Control of Heat Exchanger and Compressor to Improve Energy Efficiency

In cooling or heating mode, for a multi-unit system, the outdoor heat exchanger and compressor are independently controlled to improve energy efficiency, which means even the compressor of the outdoor unit does not operate, the heat exchanger of this outdoor unit can be used for heat exchange. This function can maximum use the outdoor heat exchanger to improve heat exchange efficiency.

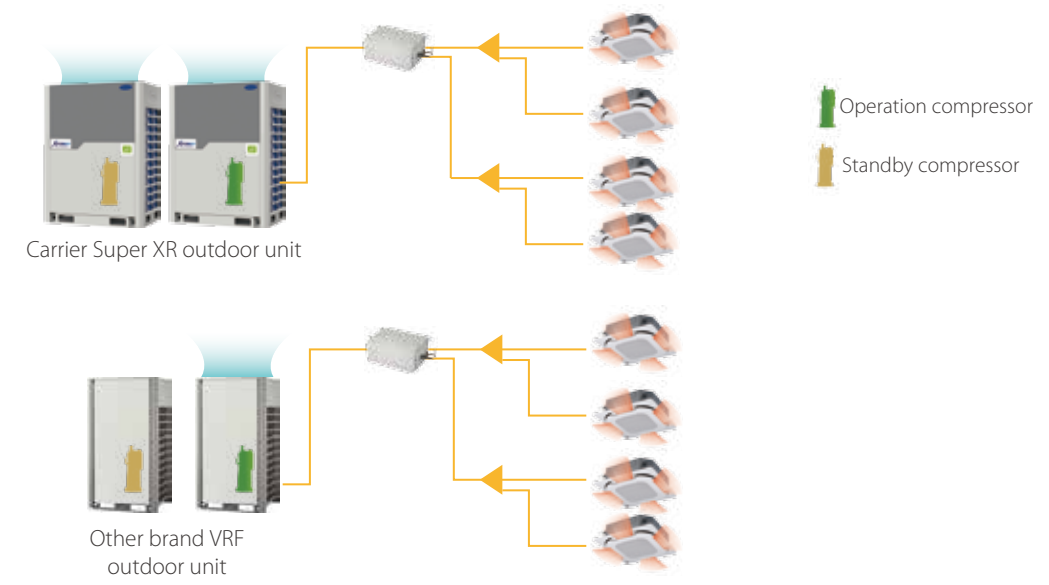

Intelligent MS Box

The Super XR Heat Recovery system can perform simultaneous heating and cooling operation through the intelligent MS-box. It switches operation mode according to user requirement while it increases efficiency with simultaneous operation.

Single Port

- ▶ Compact and light to install
- ▶ No drain piping needed
- ▶ Connect up to 8 indoor units, capacity up to 32kW
- ▶ Double direction connection for refrigerant pipe to improve installation flexibility
- ▶ Electric ball valve control precision is up to 3200-stage
 - Completely close the valve with almost no leakage
 - Can be opened and closed in stages with very low noise
 - Can achieve cooling at ambient temperatures as low as -15°C
 - High precision refrigerant flow control

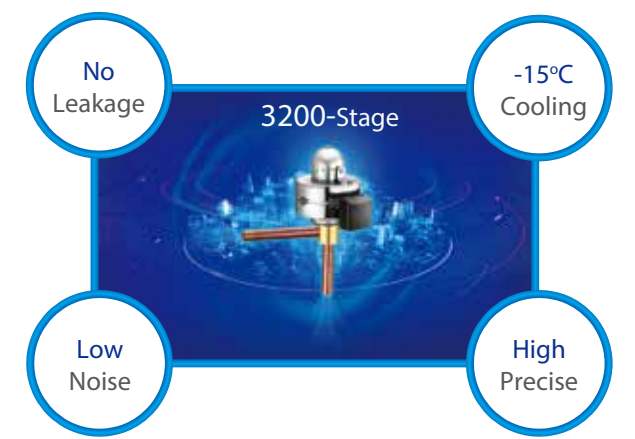

Real-time refrigerant leakage detection, safe and reliable operation.

- Real-time refrigerant leakage detection
- Provide dry contact to 3rd party for alarm and exhaust fan. When refrigerant leakage occurs, the alarm light will be on and the exhaust fan will automatically run to timely reduce the concentration of refrigerant in the room

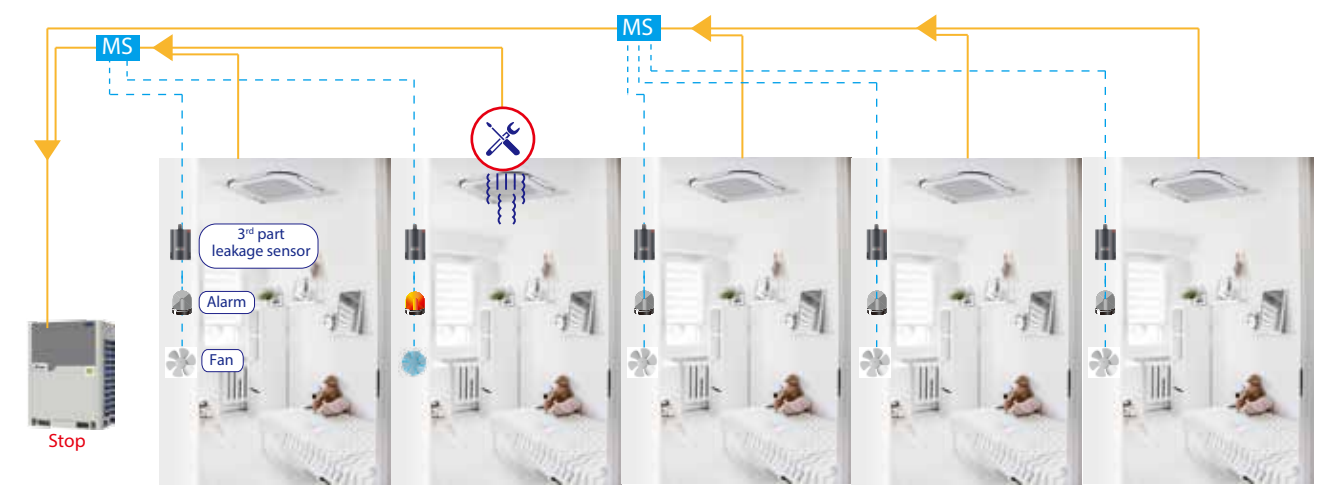

Multiple Ports: 4-6-8-10-12

- ▶ Compact and light to install
- ▶ Low noise operation
- ▶ Up to 5 indoor units can be connected to one port
- ▶ Up to 47 indoor units can be connected to one MSFT-12D-CM box
- ▶ Up to 16 kW capacity available per port
- ▶ Connect up to 280 index unit (28kW) by combining 2 ports



VRF Super XR Series - Heat Recovery

380~415V, 3N, 50/60Hz



HP		8	10	12	14	16	18	20	
Model name		38VF008T119016	38VF010T119016	38VF012T119016	38VF014T119016	38VF016T119016	38VF018T119016	38VF020T119016	
Power supply		V/N/Hz 380-415/3/50(60)							
Cooling ¹	Capacity	kW	22.4	28.0	33.5	40.0	45.0	50.0	56.0
	Power input	kW	5.25	7.18	8.64	9.83	12.00	13.81	17.39
	EER		4.27	3.90	3.88	4.07	3.75	3.62	3.22
Heating ² (Nominal)	Capacity	kW	22.4	28.0	33.5	40.0	45.0	50.0	56.0
	Power input	kW	3.96	5.46	6.57	8.26	9.78	11.90	14.77
	COP		5.66	5.13	5.10	4.84	4.60	4.20	3.79
Heating ² (Max)	Capacity	kW	25.0	31.5	37.5	45.0	50.0	56.0	63.0
	Power input	kW	4.69	7.12	9.48	9.78	12.26	14.77	18.33
	COP		5.33	4.43	3.95	4.60	4.08	3.79	3.44
Connected indoor unit	Total capacity	50-200% of outdoor unit capacity							
	Maximum quantity	64							
Compressor	Type	DC inverter							
	Quantity	1							
Fan	Type	Propeller							
	Motor type	DC							
	Quantity	1			2				
	Static pressure	Pa	0,20,40,60,80(Selectable)						
	Air flow rate	m ³ /h	9000	9500	10000	14000	14900	15800	15800
Refrigerant	Type	R410A							
	Factory charge	kg	8			10			
Pipe connections ³	Liquid pipe	mm	Φ12.7			Φ15.9			
	Low pressure gas pipe	mm	Φ25.4			Φ28.6			
	High pressure gas pipe	mm	Φ19.1			Φ22.2			
Sound pressure level ⁴	dB(A)	58	58	60	61	64	65	65	
Sound power level ⁴	dB(A)	78	78	81	81	88	88	88	
Net dimensions (WxHxD)	mm	990x1635x790			1340x1635x825				
Packed dimensions (WxHxD)	mm	1090x1805x860			1405x1805x910				
Net weight	kg	232			300				
Gross weight	kg	248			325				
Ambient temp. operation range	Cooling	°C (DB)	-15 ~ 52						
	Heating	°C (DB)	-25 ~ 19						
	Domestic hot water	°C (DB)	-20 ~ 43						

Notes:

- Indoor temperature 27°C DB, 19°C WB; outdoor temperature 35°C DB; equivalent refrigerant piping length 7.5m with zero level difference.
- Indoor temperature 20°C DB; outdoor temperature 7°C DB, 6°C WB; equivalent refrigerant piping length 7.5m with zero level difference.
- For single units, diameters given are those of the unit's stop valves. For combined units, diameters given are those for the pipe connecting the outdoor unit combination to the first indoor branch joint for systems with total equivalent liquid piping lengths of less than 90m. For systems with total equivalent liquid piping lengths of 90m or longer, please refer to the Engineering Data Book for connection piping diameters.
- Sound pressure level is measured at a position 1m in front of the unit and 1.3m above the floor in a semi-anechoic chamber.

VRF Super XR Series - MS box



Model name		MSFT-01D-CM	MSFT-04D-CM	MSFT-06D-CM	MSFT-08D-CM	MSFT-10D-CM	MSFT-12D-CM
Power supply		220-240V~ 50/60Hz					
Max. number of indoor unit groups		1	4	6	8	10	12
Max. number of units per group		8	5	5	5	5	5
Max. number of downstream indoor units		8	20	30	40	47	47
Max. capacity of each group of indoor units		kW	32	16	16	16	16
Max. total capacity of all downstream indoor units		kW	32	49	63	85	85
Pipe connections to ODU	Liquid pipe	mm	Φ9.53/Φ12.7	Φ9.53/Φ12.7/Φ15.9/Φ19.1	Φ9.53/Φ12.7/Φ15.9/Φ19.1	Φ12.7/Φ15.9/Φ19.1/Φ22.2	Φ12.7/Φ15.9/Φ19.1/Φ22.2
	Low pressure gas pipe	mm	Φ15.9/Φ19.1/Φ22.2	Φ19.1/Φ22.2/Φ28.6	Φ19.1/Φ22.2/Φ28.6	Φ22.2/Φ28.6/Φ34.9	Φ22.2/Φ28.6/Φ34.9
	High pressure gas pipe	mm	Φ12.7/Φ15.9/Φ19.1	Φ15.9/Φ19.1/Φ22.2/Φ28.6	Φ15.9/Φ19.1/Φ22.2/Φ28.6	Φ19.1/Φ22.2/Φ28.6	Φ19.1/Φ22.2/Φ28.6
Pipe connections to IDU	Liquid pipe	mm	Φ6.35/Φ9.53	Φ6.35/Φ9.53	Φ6.35/Φ9.53	Φ6.35/Φ9.53	Φ6.35/Φ9.53
	Gas pipe	mm	Φ12.7/Φ15.9	Φ12.7/Φ15.9	Φ12.7/Φ15.9	Φ12.7/Φ15.9	Φ12.7/Φ15.9
Sound pressure level ¹	dB(A)	40	44	45	47	47	47
Sound power level ¹	dB(A)	60	63	65	65	65	65
Net dimensions (WxHxD)	mm	440x195x296	668x250x574	668x250x574	974x250x574	974x250x574	974x250x574
Packed dimensions (WxHxD)	mm	740x275x405	1020x390x850	1020x390x850	1320x390x850	1320x390x850	1320x390x850
Net weight	kg	10.5	33	36	48	51	54
Gross weight	kg	14	58	61	79	82	85

VRF Super XR Series - High temperature hydro module



Model	HWM-D04801	
Power supply		
220-240V~ 50/60Hz		
Heating Capacity ¹		kW
		14
Operating temperature range	Heating	°C
	Domestic hot water	°C
		-20~30
		-20~43
Water temperature		°C
		25~80
Water flow rate	Nominal (Min.-Max.)	m ³ /h
		2.4 (1.2-2.9)
Allowable water pressure		Bar
		1-10
Refrigerant	Type	
	Factory charge	kg
		R134a
		1.2
Sound pressure level		dB(A)
		44
Net dimensions (WxHxD)		mm
		450x795x300
Packed dimensions (WxHxD)		mm
		698x945x390
Net / Gross weight		kg
		58 / 67.2
Refrigerant pipe	Connection type	
	Brazing	
Water pipe	Liquid pipe diameter	mm
	Φ9.53	
Water pipe	Gas pipe diameter	mm
	Φ12.7	
Water pipe	Connection type	
	External thread	
Water pipe	Inlet pipe diameter	mm
		Φ25.4
Water pipe	Outlet pipe diameter	mm
		Φ25.4
Unit installation ambient temperature range		°C
		0~40
Unit installation place		
		Indoor only

Note:

Nominal heating capacities are based on the following conditions: ambient temperature 7°C DB/6°C WB; Water inlet/outlet temperature 40°C DB/45°C;

Recommended combination table

System capacity		Number	Modules ¹							Outdoor branch
kW	HP	of units	8	10	12	14	16	18	20	Joint kit ²
22.4	8	1	●							—
28	10	1		●						
33.5	12	1			●					
40	14	1				●				
45	16	1					●			
50	18	1						●		
56	20	1							●	BJCTB-02-CM(i)
61.5	22	2		●	●					
68	24	2		●		●				
73.5	26	2			●	●				
78.5	28	2			●		●			
83.5	30	2			●			●		
90	32	2					●●			BJCTB-03-CM(i)
95	34	2					●	●		
100	36	2						●●		
106	38	2						●	●	
112	40	2							●●	
118.5	42	3			●	●	●			
123.5	44	3			●		●●			
130	46	3				●	●●			
135	48	3					●●●			
140	50	3					●●	●		
145	52	3					●	●●		
150	54	3						●●●		
156	56	3						●●	●	
162	58	3						●	●●	
168	60	3							●●●	

Notes:
 1.The combinations of units shown in the table are factory-recommended. Other combinations of units are also possible.
 2.For systems with two or more outdoor units, outdoor branch joints (sold separately) are required.

Dimensions

Body dimension

Unit: in.(mm)

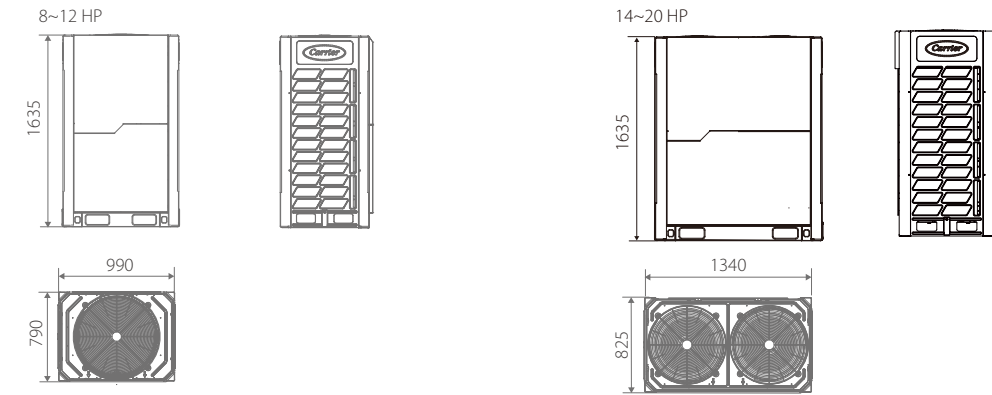

Installation dimension

Unit: in.(mm)

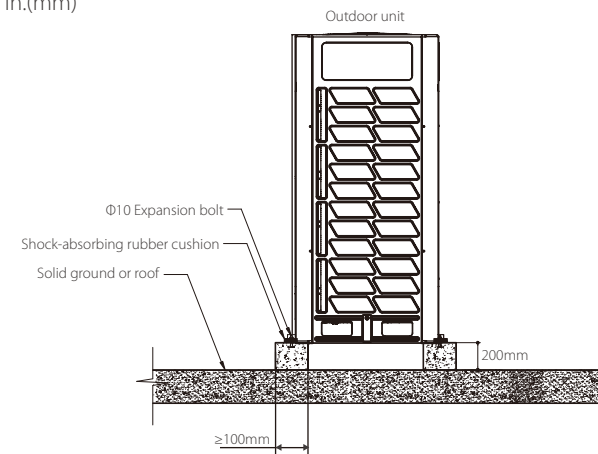

Expansion bolt positioning (Unit: mm)

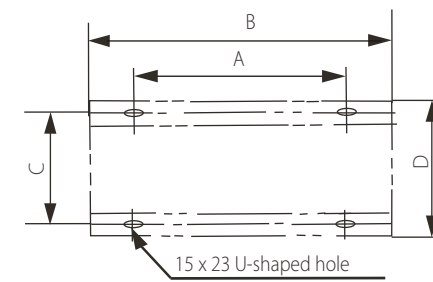

HP SIZE	8,10,12	14,16,18,20
A	740	1090
B	990	1340
C	723	723
D	790	790

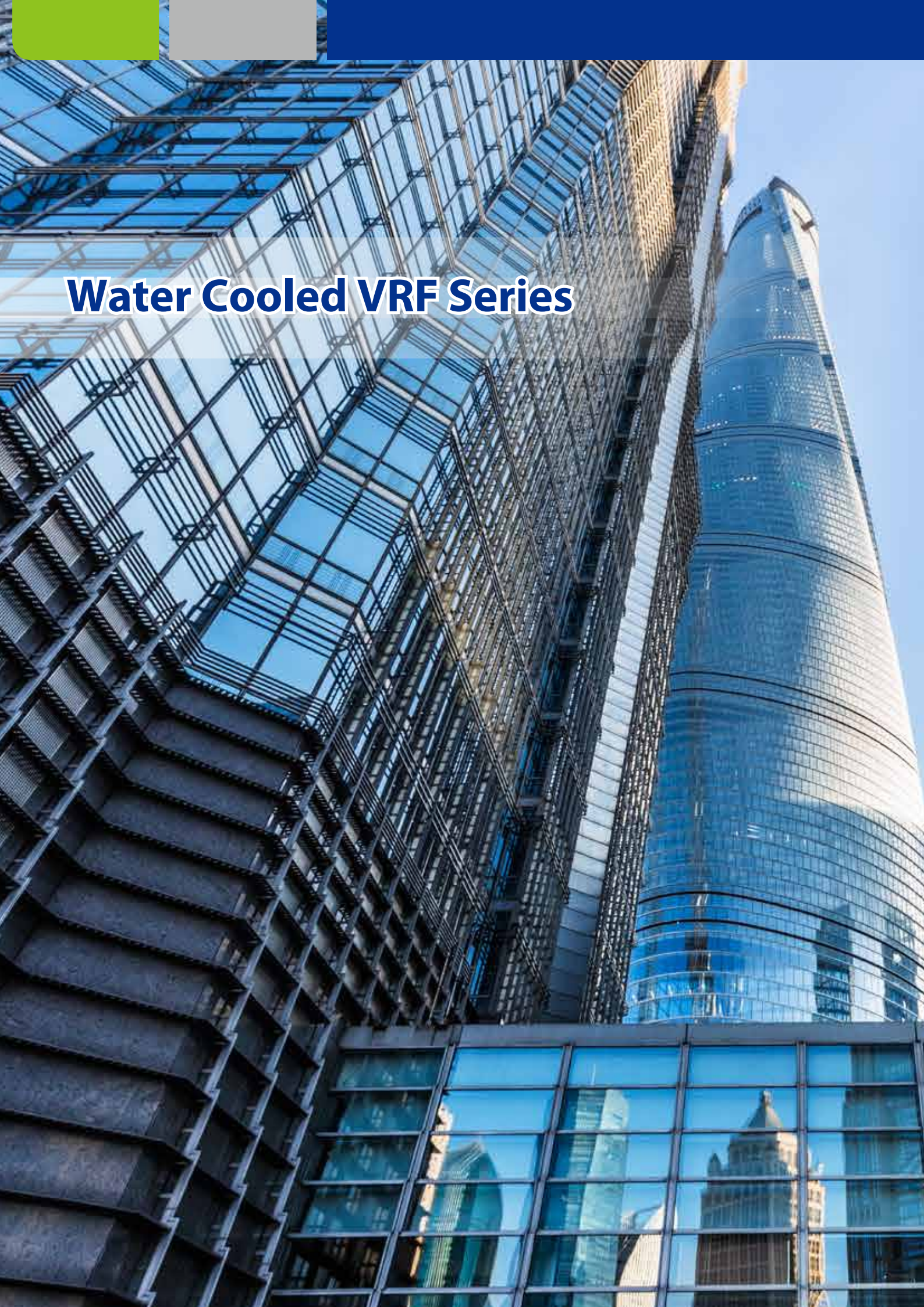

Water Cooled VRF Series

Wide Range of Outdoor Units

The Water Cooled Series capacity ranges from 8HP to 36HP, meets all customer requirements from small to large buildings.



Long Piping Length

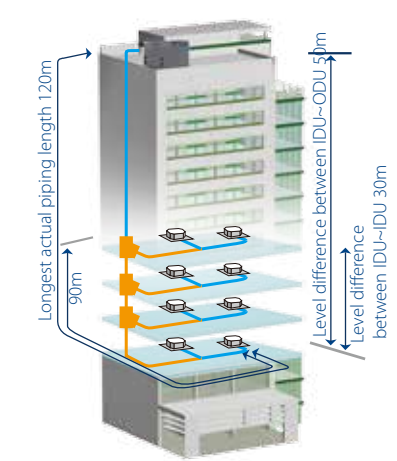

Total piping length	300m
Longest length actual (Equivalent)	120(150)m
Longest length after first branch	90*m
Level difference between indoor and outdoor units - ODU up (down)	50(40)m
Level difference between indoor units	30m

*The longest piping length is 40m standard. It can be extended to 90m. When the length is over 40m, please contact your local Carrier sales company for more information and restrictions.

Wide Operation Temperature Range

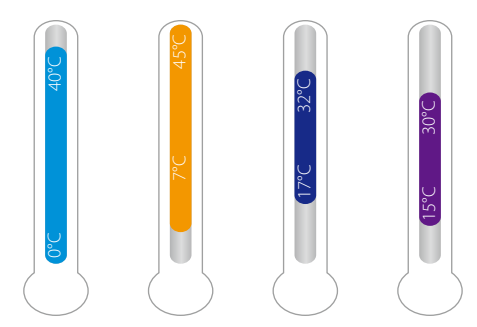

- Main unit ambient temperature: 0°C~40°C
- Main unit water inlet temperature: 7°C~45°C
- Indoor temperature in cooling mode: 17°C~32°C
- Indoor temperature in heating mode: 15°C~30°C

High IPLV

Water cooled VRF Series System combines water system and refrigerant system perfectly. IPLV(C) reaches as high as 20.13. Compared with air-cooled VRF, energy saving is higher.

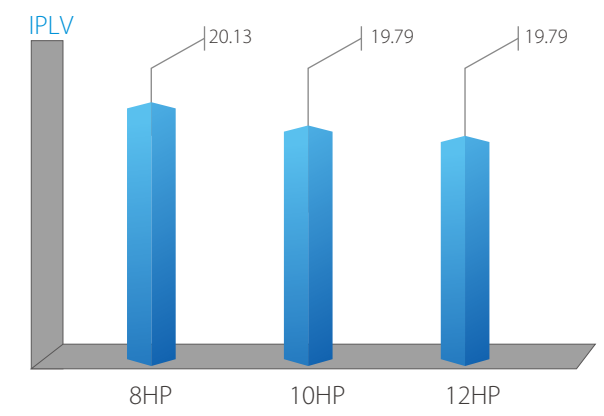

High Efficiency Double-Pipe Heat Exchanger

With the innovatively designed double-pipe heat exchanger, the water quality required is low. The water side has large circulation area, and it is not easily plugged, creating higher reliability and easier cleaning and maintenance.



Water Side Heat Recovery Function

In modern large-scale buildings, the load between the internal and external areas is different. It may occur in some situations that both cooling and heating are required. The water cooled VRF Series not only can achieve meticulous system division in different areas but also can recover heat at the same time, significantly improving energy efficiency.

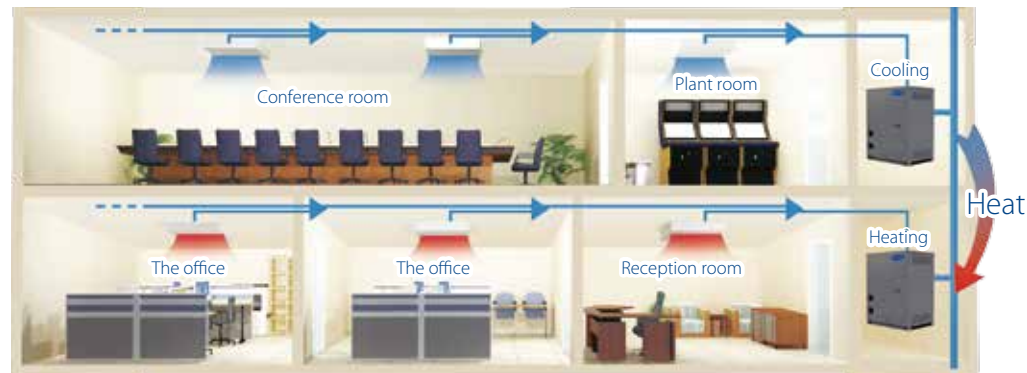

No Water Leakage

No water pipes installed indoors, no water leakage risks.

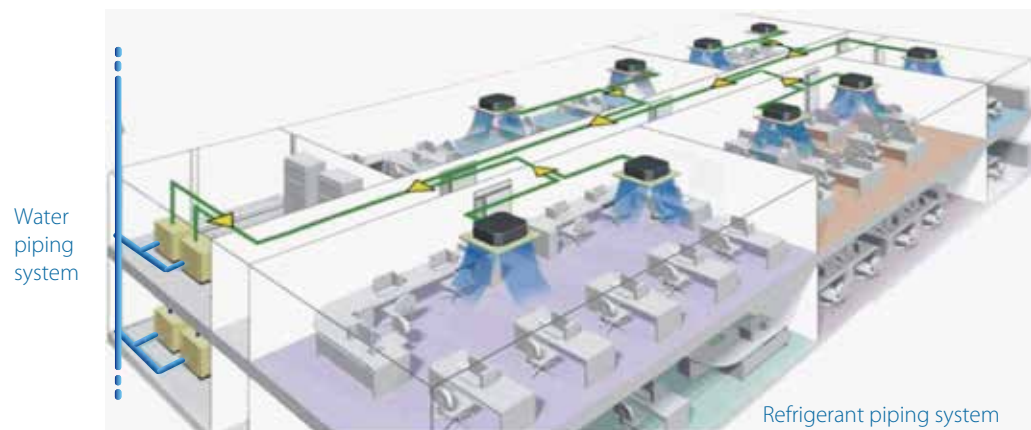

Specifications

Water Cooled VRF Series

Model		38W008H117010 38W008H118010 38W008H119010	38W010H117010 38W010H118010 38W010H119010	38W012H117010 38W012H118010 38W012H119010	
Power supply	V-Ph-Hz	208/230V-3Ph-60Hz 380-415V-3Ph-60Hz 380-415V-3Ph-50Hz			
Cooling	Capacity	W	25200	28000	33500
	Input	W	4800	6100	8000
	EER	KBtu/h/kW	17.91	15.66	14.30
Heating	Capacity	W	27000	31500	37500
	Input	W	4450	5830	7800
	COP	KBtu/h/kW	20.71	18.42	16.41
Connectable indoor unit	Total capacity	50-130% of outdoor unit capacity			
	Max quantity		13	16	19
Max current	A	23	23	23	
Compressor	Quantities	1			
	Type	DC Inverter			
Heat exchanger	Type	Double-pipe heat exchanger			
	Rated water flow volume	m ³ /h	5.4	6	7.2
Outdoor sound level(*3)	dB(A)	51	52	52	
Main unit	Dimension (WxHxD)	mm	780x1000x550		
	Packing (WxHxD)	mm	845x1170x600		
	Net/Gross weight	kg	146/155	147/156	
Charged refrigerant type and volume	kg	R410A 2kg			
Throttle type		EXV			
Excessive operating pressure	MPa	4.4/2.6			
Liquid side/ Gas side	mm	Φ12.7/Φ25.4	Φ12.7/Φ25.4	Φ15.9/Φ31.8	
Main unit water inlet temp.	°C	7°C—45°C			
Main unit ambient temp. range	°C	0°C—40°C			
Main unit ambient humidity		Below 80%			

Dimensions

Body dimension

Unit: (mm)

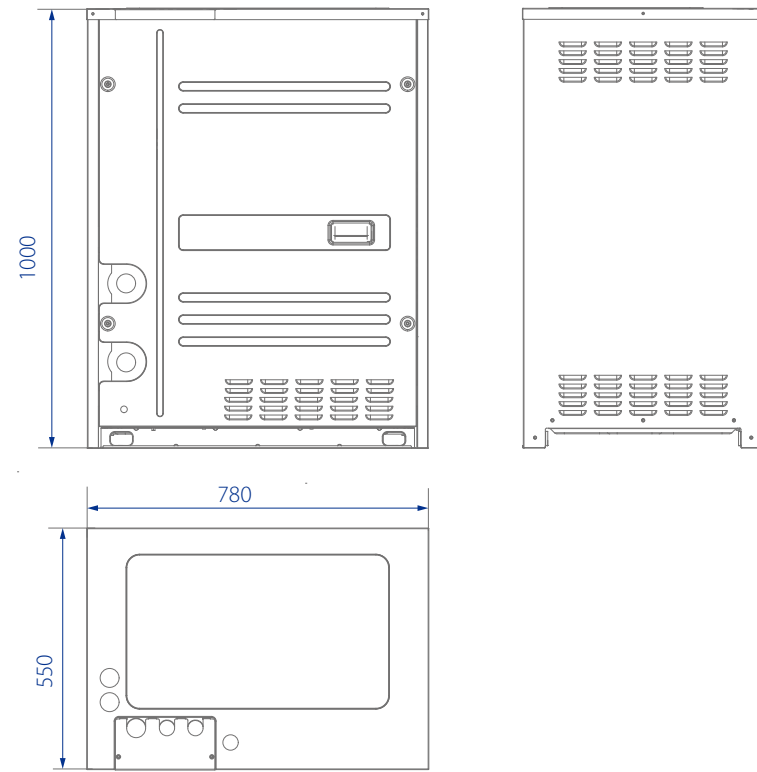

Installation dimension

Unit: (mm)

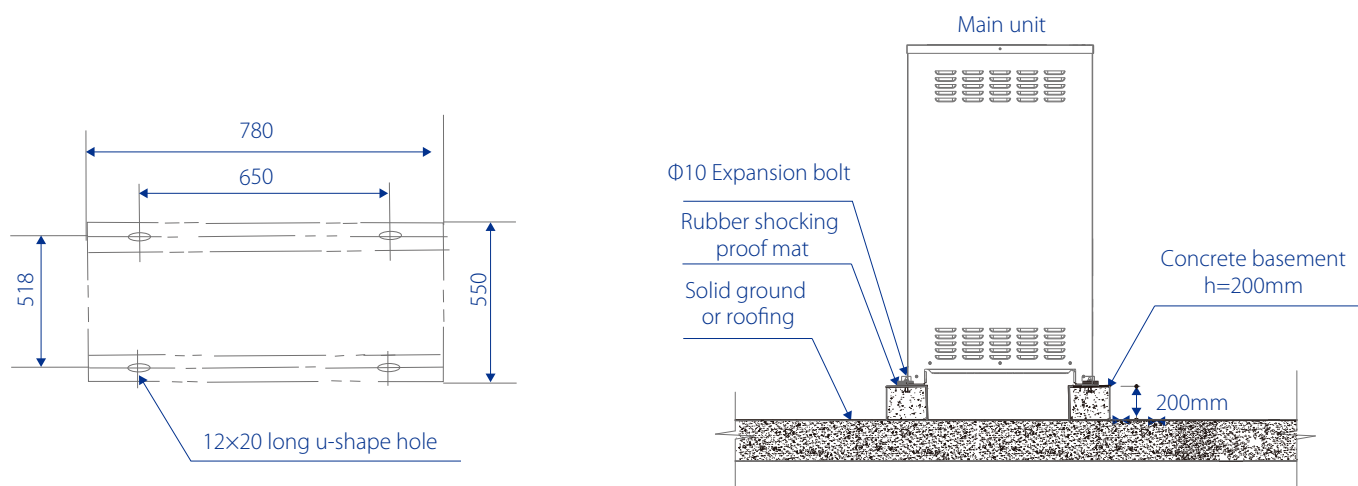

Recommended combination table

Capacity (HP)	No. of units	No. of compressor	Recommend combination			Max No. of connectable indoor unit	Cooling capacity		Heating capacity	
			8(HP)	10(HP)	12(HP)		kW	kBtu/h	kW	kBtu/h
8	1	1	●			13	25.2	86.0	27	92.1
10	1	1		●		16	28	95.5	31.5	107.4
12	1	1			●	19	33.5	114.3	37.5	127.9
16	2	2	●●			23	45	153.5	54	184.2
18	2	2	●	●		29	50	170.6	58.5	199.6
20	2	2		●●		33	56	191.1	63	214.9
22	2	2		●	●	36	61.5	209.8	69	235.4
24	2	2			●●	39	67	228.6	75	255.9
26	3	3	●●	●		43	73	249.1	85.5	291.7
28	3	3	●	●●		46	78.5	267.8	90	307.0
30	3	3		●●●		50	85	290.0	94.5	322.4
32	3	3		●●	●	53	90	307.1	100.5	342.9
34	3	3		●	●●	56	95	324.1	106.5	363.3
36	3	3			●●●	59	101.5	346.3	112.5	383.8

Notes:

Capacities are based on the following conditions:

Cooling: Indoor temperature 27°C DB/19°C WB; Outdoor temperature 35°C DB/24°C WB

Heating: Indoor temperature 20°C DB/15°C WB; Outdoor temperature 7°C DB/6°C WB

Piping length: Interconnecting piping length is 7.5m , level difference is zero.

The above combination models are factory-recommended models

Side Discharge Series Heat Pump & Cooling Only



NEW
Fashion Design

R-410A

DC Inverter

Features

Wide Application Range

Wide range of outdoor units

			8	10	12	14	16	17.5	20	22.4	26	28	33.5	40	45
			27.3	35.8	40.9	47.8	52.9	60	68.2	76.4	88.7	95.5	114.3	136.5	153.5
Air Cooled - Heat Pump	Super XS series 380-415V/3Ph/50(60)Hz								●	●	●	●	●		
	Mini H series 380-415V/3Ph/50(60)Hz								●	●	●	●	●	●	●
	Mini H series 220-240V/1 Ph/50Hz or 208-230V/1 Ph/60Hz		●	●	●	●	●	●							
	Super XS series 220-240V/1Ph/50(60)Hz		●	●	●	●	●								
Air Cooled - Cooling Only	Super XS series 380-415V/3Ph/50 or 60 Hz								●	●	●	●			
	220-240V/1Ph/50Hz & 208-230V/1Ph/60Hz		●	●		●	●								

● Single unit

Flexible indoor units connection

Mini VRF with intelligent control gives you independent zoning control with maximum flexibility.

A single outdoor unit supports up to nine indoor units, freeing up considerable space outside. Use your backyard more wisely with much more space available created by less number of outdoor units.

- Max. 7 indoor units for a 15.5kW(52,900Btu/h) outdoor unit installation
- Max. 6 indoor units for a 14kW(47,800Btu/h) outdoor unit installation
- Max. 6 indoor units for a 12kW(40,900Btu/h) outdoor unit installation
- Max. 5 indoor units for a 10.5kW(35,800Btu/h) outdoor unit installation
- Max.4 indoor units for a 8kW(27,300Btu/h outdoor unit installation)



* For 20-45KW unit, please check the information in the specifications.

Flexible piping design

The Mini VRF provides a total piping length possibility of 250m, a maximum height difference between outdoor and indoor units of 30m. The height difference between indoors unit can be up to 8m. These generous allowances facilitate an extensive array of system designs.

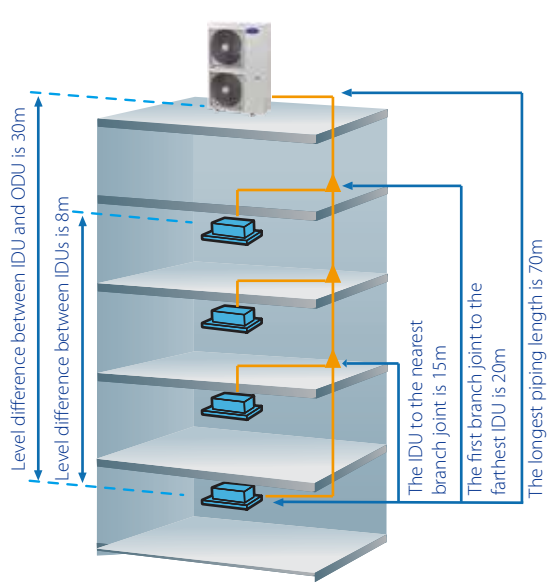

Mini H VRF piping capability

Permitted value		8/10.5kW (27.3/35.8kBtu/h)	12/14/15.5/17.5kW (40.9/47.8/ 52.9/60.6kBtu/h)	20/22.4/26/28/33.5kW (68.2/76.4/88.7/95.9/ 114.3kBtu/h)	40/45kW 136.5/153.5kBtu/h	
Piping length	Total piping length (Actual)	100m	100m	120m	250m	
	Longest piping (L)	Actual length	45m	60m	60m	100m
Equivalent length		50m	70m	70m	120m	
Level difference	Equivalent piping length (from the farthest IDU to the first indoor branch joint)		20m	20m	20m	40m
	Level difference between IDU-ODU	Outdoor unit up	30m	30m	30m	30m
		Outdoor unit down	20m	20m	20m	20m
	Level difference between IDU-IDU		8m	8m	8m	8m

1 Total pipe length is equal to all the liquid pipe or all the gas pipe length.
2 When the total equivalent pipe length of liquid side plus gas side is more than 90m(295.2ft), it needs to meet the specific conditions according to the installation part of the technical manual.

Super XS piping capability

Items	Capability(m)							
Capacity(kW)	7.2	9/12.2	14/15.5	20	22.4	26	28.5	33.5
Capacity(kBtu/h)	24.6	30.7/40.9	47.8/52.9	68.2	76.8	88.7	97.2	114.3
Total piping length	50	65	100	150				
Longest piping length-actual (equivalent)	35 (40)	45 (50)	60 (70)	100(110)				
Longest piping length after first branch	20			40				
Largest level difference between IDUs and ODU-ODU up (down)	10 (10)	20 (20)	30 (20)	50(40)				
Largest level difference between IDUs	8	8	8	15				

High performance heat exchanger

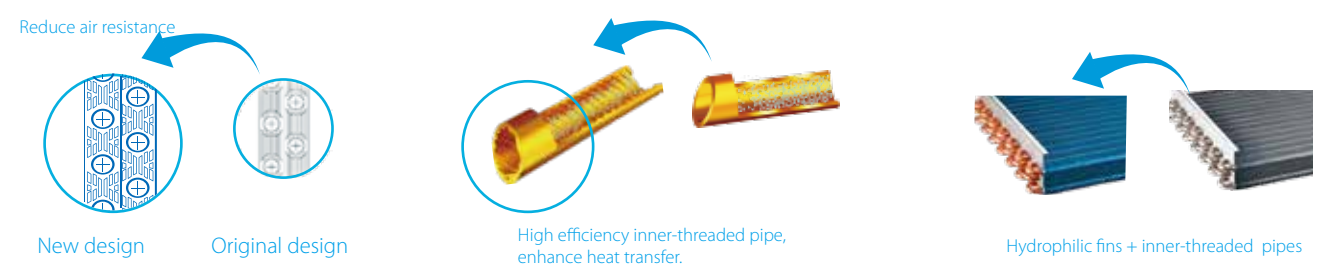

- The new designed window fins enlarge the heat-exchanging area, decrease the air resistance, save more power and enhance heat exchange performance.
- Hydrophilic film fins and inner-threaded copper pipes optimize heat exchange efficiency.
- The specially coated blue fins enhance durability and protect against corrosion from air, water and other corrosive agents, assures a longer coil service life.

More convenience in installation

A four-direction space is available for connecting pipes and wiring in various installation sites.

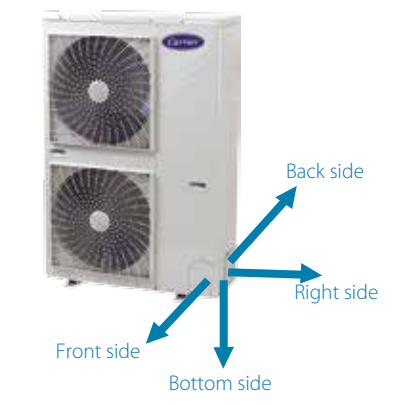
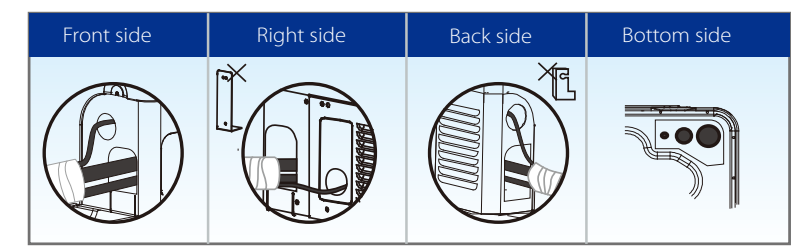

More convenient piping connector - branch box

Easier and safer installation thanks to a branch box that simplifies piping work and the adoption of screw connection.

Both left and right pipe flare connection from outdoor unit to branch box is reserved, which greatly simplifies field installation.

Two sets of pipe size converter are packed with branch box to transfer the pipe size from $\Phi 6.35\text{mm}$ to $\Phi 9.53\text{mm}$ and from $\Phi 12.7\text{mm}$ to $\Phi 15.9\text{mm}$.

Low noise

The branch pipe is linear expansion design regulates the flow of refrigerant and reduces the noise. By locating the branch box in the ceiling or outside, noise generated by the branch box can be kept clear of living spaces, thus makes noise level to a minimum.



Brazing-free quick installation

All the piping leading to and from the branch box is connected using screw joints, which can be installed quickly and easily.

Indoor installation

The branch box can be installed in the ceiling rather than outside. Removing the side and bottom covers provides easy access for maintaining inner components such as circuit boards.

New piping connection design

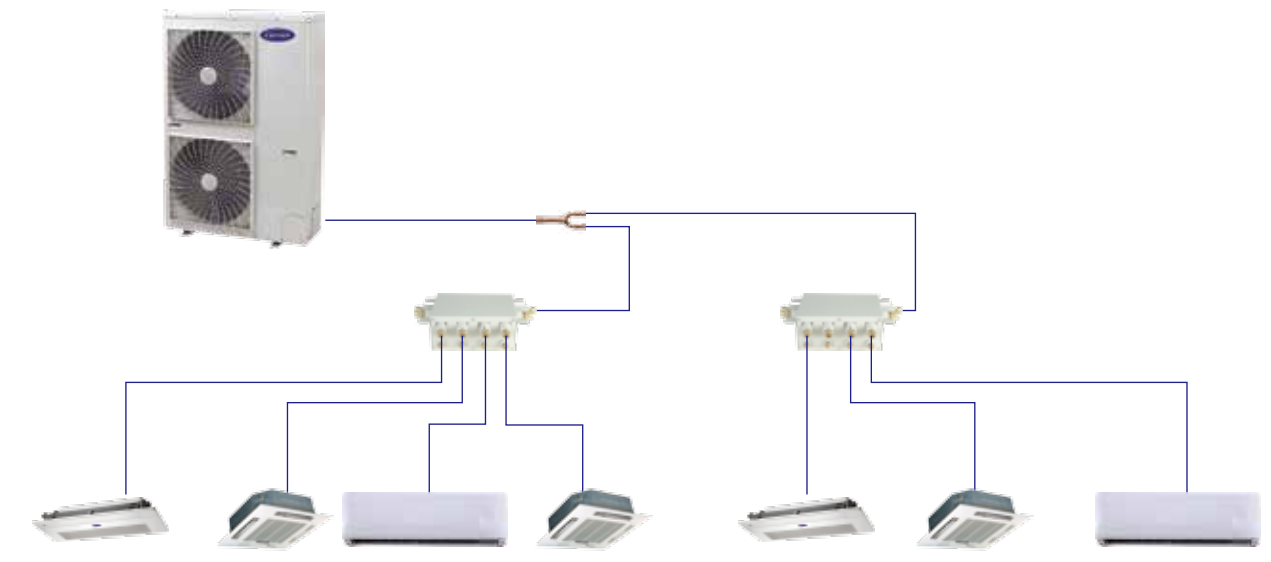

*40/45KW unit can not connect branch box

Advanced Technologies

Full DC inverter technology

At the heart of our system is a highly intelligent inverter driven compressor. This advanced technology enables the output of the outdoor unit to be modulated by the cooling or heating demands of the zone that it controls. This advanced system ensures precise temperature regulation and highly efficient energy usage, making a significant contribution to the limiting the impact on the environment.

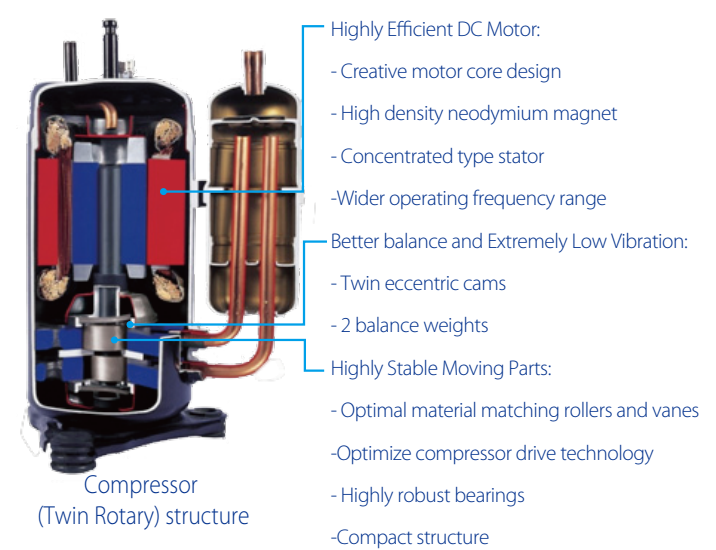

High efficiency DC fan motor saved power up to 50%.

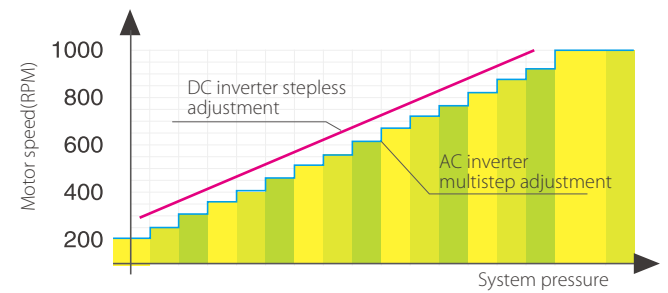

Noise reducing design

Optimally designed fan shape and air discharge grille increases air volume and reduces running noise.

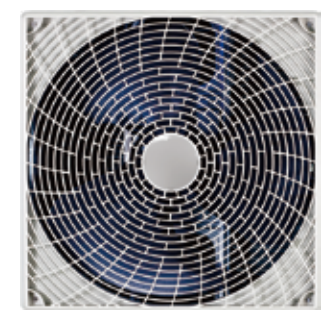
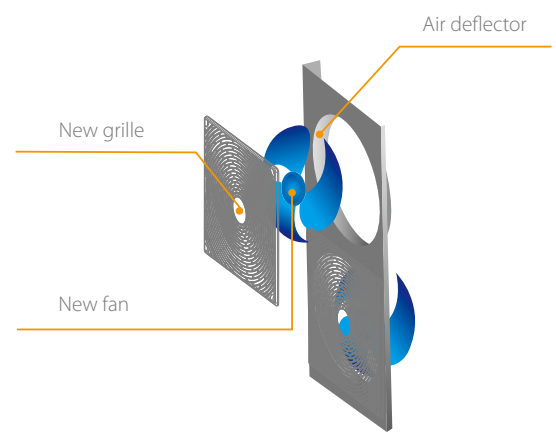

Newly Designed Fan Guard

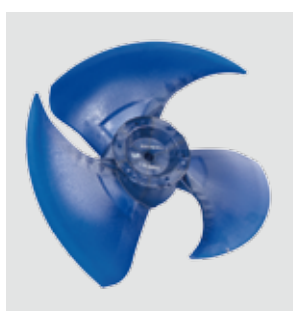

Powerful Large Propeller

Mini H Series – Heat Pump 3 Phase



380/415V-3Ph~60Hz	220V 3N~60Hz	380-415V 3N~ 50Hz		
38VR004H118010	38VR008H11701S	38VR004H119010	38VR007H119010	38VR012H11901S
38VR005H118010	38VR010H11701S	38VR005H119010	38VR008H11901S	38VR014H11901S
38VR006H118010		38VR006H119010	38VR010H11901S	38VR016H11901S

Specifications 60Hz

Sales Model			38VR004H118010	38VR005H118010	38VR006H118010	38VR008H11701S	38VR010H11701S
Power supply		V-Ph-Hz	380/415V-3Ph~60Hz	380/415V-3Ph~60Hz	380/415V-3Ph~60Hz	220V 3N~60Hz	220V 3N~60Hz
Cooling	Capacity	kW	12	14	15.5	25.2	28
		RT	3.4	4.0	4.4	7.1	7.95
	Input	kW	3.25	3.95	4.52	6.8	7.8
	EER	KBtu/h/kW	12.59	12.08	11.70	12.65	12.24
Heating	Capacity	kW	13.2	15.4	17	27	31.5
		RT	3.8	4.4	4.9	7.7	8.95
	Input	kW	3.47	4.16	4.77	6.4	7.6
	COP	KBtu/h/kW	12.97	12.62	12.15	14.4	14.12
Outdoor sound level (*3)		dB(A)	57	57	57	58	60
Pipe connections	Liquid side	mm	Φ9.53	Φ9.53	Φ9.53	Φ9.53	Φ9.53
	Gas side	mm	Φ15.9	Φ15.9	Φ19.1	Φ22.2	Φ22.2
Connectable	Total capacity	%	50-130%	50-130%	50-130%	50-130%	50-130%
	Max.quantity		6	6	7	11	12
Compressor	Type		Rotary	Rotary	Rotary	Rotary	Rotary
	Brand		MITSUBISHI	MITSUBISHI	MITSUBISHI	MITSUBISHI	MITSUBISHI
	Capacity	kW	9.8	9.8	14	17.1	17.1
	Crankcase	W	27	27	25	25	25
	Refrigerant oil	Type	FV50S	FV50S	FV50S	FV50S	FV50S
	Refrigerant oil	ml	870	870	1400	1700+1500	1700+1500
	Type		DC motor	DC motor	DC motor	DC motor	DC motor
Fan Motor	Quantity		2	2	2	2	2
	Output	W	2 x85	2 x85	2 x 85	200(up)/150(down)	200(up)/150(down)
	Airflow	CFM	4100	3824	3530	6173	6173
m ³ /h		6983	6500	6000	10494	10494	
Outdoor unit	Dimension(W x H x D)	mm	900 x 1327 x 400	900 x 1327 x 400	900 x 1327 x 400	1120 x 1558 x 528	1120 x 1558 x 528
	Packing (W x H x D)	mm	1030 x 1456 x 435	1030 x 1456 x 435	1030 x 1456 x 435	1270 x 1720 x 565	1270 x 1720 x 565
	Net/Gross weight	kg	92/106	95/106	102/113	146.5/162.5	147/163
Refrigerant	Type		R410A	R410A	R410A	R410A	R410A
	Charged volume	g	3300	3900	3900	3100	3100
Throttle type			EXV				
Design pressure		MPa	4.4/2.6				
Ambient temp	Cooling	°C	-15~43			-5-48	
	Heating	°C	-15~27			-15-24	

Note:
 1. The cooling conditions: indoor temp.: 27°C DB, 19 °C WB outdoor temp.: 35°C DB equivalent pipe length: 5m drop length: 0m.
 2. The heating conditions: indoor temp.: 20°C DB, 15°C WB outdoor temp.: 7 °C DB equivalent pipe length: 5m drop length: 0m.
 3. Sound level: Anechoic chamber conversion value, measured at a point 1 m in front of the unit at a height of *m(1m for 105 model, 1.2m for 120~160model). During actual operation, these values might be higher as a result of ambient conditions.
 4. The above data may be changed without notice for future improvement on quality and performance.

Specifications 50Hz

Sales Model		38VR004H119010	38VR005H119010	38VR006H119010	38VR007H119015	
Power supply		V-Ph-Hz	380-415V-3N~50Hz	380-415V-3N~50Hz	380-415V-3N~50Hz	380-415V-3N~50Hz
Cooling	Capacity	kW	12.3	14	15.5	17.5
		RT	3.5	4.0	4.4	4.9
	Input	kW	3.25	3.95	4.52	5.3
	EER	KBtu/h/kW	12.90	12.08	11.70	11.26
Heating	Capacity	kW	13.2	15.4	17	19
		RT	3.8	4.4	4.9	5.4
	Input	kW	3.47	4.16	4.77	5.0
	COP	KBtu/h/kW	12.97	12.62	12.15	13.0
Connectable indoor unit	Total capacity	%	50-130%	50-130%	50-130%	50-130%
	Max.quantity		6	6	7	7
Outdoor sound level (sound pressure level)		dB(A)	57	57	57	59
Refrigerant Pipe	Liquid side	mm	Φ9.53	Φ9.53	Φ9.53	Φ9.53
	Gas side	mm	Φ15.9	Φ15.9	Φ19.1	Φ19.1
Compressor	Type		Rotary	Rotary	Rotary	Rotary
	Brand		mitsubishi	mitsubishi	mitsubishi	mitsubishi
	Capacity	Btu/h	33720	33720	47700	47700
	Crankcase	W	27	27	25	25
	Refrigerant oil	ml	FV50S 870ml	FV50S 870ml	FV50S 1400ml	FV50S 1400ml
	Quantities			2	2	2
Fan motor	Type		DC motor	DC motor	DC motor	DC motor
	Air flow rate	m³/h	6000	6000	6000	6800
		CFM	3529	3529	3529	4000
	Dimension(W*H*D)		mm	900*1327*400	900*1327*400	900*1327*400
Outdoor unit	Packing (W*H*D)	mm	1030*1456*435	1030*1456*435	1030*1456*435	1030*1456*435
	Net/Gross weight	kg	95/106	95/106	102/113	107/118
	Type		R410A	R410A	R410A	R410A
Refrigerant	Charged volume	g	3300	3900	3900	4500
Throttle type			EXV	EXV	EXV	EXV
Design pressure		MPa	4.4/2.6	4.4/2.6	4.4/2.6	4.4/2.6
Ambient temp	Cooling	°C	-15~43			
	Heating		-15~27			

Note:

- The cooling conditions: indoor temp.: 27°C DB, 19 °C WB outdoor temp.: 35°C DB equivalent pipe length: 5m drop length: 0m.
- The heating conditions: indoor temp.: 20°C DB, 15°C WB outdoor temp.: 7 °C DB equivalent pipe length: 5m drop length: 0m.
- Sound level: Anechoic chamber conversion value, measured at a point 1 m in front of the unit at a height of 1.2m. During actual operation, sound level might be affected by ambient conditions.
- The above data may be changed without notice for future improvement on quality and performance.

Specifications 50Hz

Sales Model		38VR007H119010	38VR008H119015	38VR010H119015	38VR012H119015	38VR014H119015	38VR016H119015	
Power supply		V-Ph-Hz	380-415V-3N~50Hz	380-415V-3N~50Hz	380-415V-3N~50Hz	380-415-3N~50Hz	380-415-3N~50Hz	
Cooling	Capacity	kW	20	22.4	26	33.5	40	45
		RT	5.7	6.4	7.4	9.5	11.4	12.9
	Input	kW	6.1	6.8	7.6	9.85	11.9	13.6
	EER	KBtu/h/kW	11.19	11.23	11.67	11.6	11.43	11.33
Heating	Capacity	kW	22	24.5	28.5	33.5	45	50
		RT	6.29	7	8.1	9.5	12.86	14.3
	Input	kW	6.1	5.9	6.8	8.38	11.1	12.7
	COP	KBtu/h/kW	12.32	14.16	14.30	13.65	13.82	13.41
Outdoor sound level(*3)		dB(A)	59	59	60	62	62	62
Pipe connections	Liquid side	mm	Φ9.53	Φ9.53	Φ9.53	Φ12.7	Φ12.7	Φ12.7
	Gas side	mm	Φ19.1	Φ19.1	Φ22.2	Φ22.2	Φ22.2	Φ25.4
Connectable	Total capacity	%	50-130%	50-130%	50-130%	50-130%	50-130%	50-130%
	Max.quantity		10	11	12	13	14	15
Compressor	Type		Rotary	Rotary	Rotary	Rotary	Rotary	Rotary
	Brand		mitsubishi	mitsubishi	mitsubishi	mitsubishi	mitsubishi	mitsubishi
	Capacity	Btu/h	13980	16860	16860	57526	13980x2	16860x2
	Crankcase	W	25	25	25	5.2	25x2	25x2
	Refrigerant oil	Type	FV50S	FV50S	FV50S	FV50S	FV50S	FV50S
	Refrigerant oil	ml	1400+1300	1700+1500	1700+1500	1700+1500	1400x2+2500	1700x2+3600
Fan Motor	Type		DC motor	DC motor	DC motor	DC	DC+AC	DC+AC
	Quantity		2	2	2	2	1+1	1+1
	Output	W	210/160	200/150	200/150	220+180	560/320	560/320
		CFM	6470	6173	6173	6374	9750	9750
Outdoor unit	Dimension(WxHxD)	mm	1120x1558x528	1120x1558x528	1120x1558x528	1120x1558x528	1360x1650x540	1460x1650x540
		mm	1270x1720x565	1270x1720x565	1270x1720x565	1270x1720x565	1450x1785x560	1550x1785x560
	Net/Gross weight	kg	137/153	146.5/162.5	147/163	157/173	240/260	275/290
Refrigerant	Type		R410A	R410A	R410A	R410A	R410A	R410A
	Charged volume	g	4800	6200	6200	3750	9000	12000
Throttle type			EXV					
Design pressure		MPa	4.4/2.6					
Ambient temp	Cooling	°C	-15~46	-15~46	-15~46	-5~48	-5~48	-5~48
	Heating		-15~24	-15~24	-15~24	-15~24	-15~24	-15~24

Note:

- The cooling conditions: indoor temp.: 27°C DB, 19 °C WB outdoor temp.: 35°C DB equivalent pipe length: 5m drop length: 0m.
- The heating conditions: indoor temp.: 20°C DB, 15°C WB outdoor temp.: 7 °C DB equivalent pipe length: 5m drop length: 0m.
- Sound level: Anechoic chamber conversion value, measured at a point 1 m in front of the unit at a height of 1.2m. During actual operation, sound level might be affected by ambient conditions.
- The above data may be changed without notice for future improvement on quality and performance.

Mini H Series - Heat Pump 1 Phase



208/230V~1Ph~60Hz

38VR004H11301S
38VR004H113010
38VR005H113010
38VR006H113010

220-240V/1Ph~50Hz

38VR003H112010 38VR005H112010
38VR004H11201S 38VR006H112010
38VR004H112010

Specifications 60Hz

Sale Model			38VR004H11301S	38VR004H113010	38VR005H113010	38VR006H113010	
Power supply		V-Ph-Hz	208/230V-1Ph~60Hz	208/230V-1Ph~60Hz	208/230V-1Ph~60Hz	208/230V-1Ph~60Hz	
Cooling	Capacity	kW	10.5	12	14	15.5	
		RT	3	3.4	4.0	4.4	
	Input	kW	2.68	3.25	3.95	4.52	
	EER	KBtu/h/kW	13.38	12.59	12.08	11.70	
Heating	Capacity	kW	11.5	13.2	15.4	17	
		RT	3.3	3.8	4.4	4.9	
	Input	kW	2.9	3.47	4.16	4.77	
Coneectable indoor unit	COP	KBtu/h/kW	13.55	12.97	12.62	12.15	
	Total capacity	%	50-130%	50-130%	50-130%	50-130%	
Outdoor sound level (*3)	Max.quantity		5	6	6	7	
		dB(A)	57	57	57	57	
Pipe connections	Liquid side	mm	Φ9.53	Φ9.53	Φ9.53	Φ9.53	
	Gas side	mm	Φ15.9	Φ15.9	Φ15.9	Φ19.1	
Compressor	Type		Rotary	Rotary	Rotary	Rotary	
	Brand		mitsubishi	mitsubishi	mitsubishi	mitsubishi	
	Capacity	Btu/h	24330	33710	33710	47713	
	Input	W	2200	3010	3010	4240	
	Crankcase	W	25	27	25	20	
		Type		FV50S	FV50S	FV50S	FV50S
Refrigerant oil	ml		670	870	870	1400	
	Type		DC motor	DC motor	DC motor	DC motor	
Fan Motor	Quantity		1	2	2	2	
	Output	W	170	2 x 85	2 x 85	2 x 85	
	Air floor rate	CFM		3000	3531	3531	3531
		m ³ /h		5100	6000	6000	6000
Outdoor unit	Dimension(WxHxD)	mm	1075x966x396	900x1327x400			
	Packing (W x H x D)	mm	1120x1100x435	1030x1456x435			
	Net/Gross weight	kg	78/85	95/106	95/106	102/113	
Refrigerant	Type		R410a				
	Charged volume	kg	3	3.3	3.9	3.9	
Throttle type			EXV	EXV	EXV	EXV	
Design pressure		MPa	4.4/2.6	4.4/2.6	4.4/2.6	4.4/2.6	
Ambient temperature range	Cooling	°C	-15~43				
	Heating	°C	-15~27				

Note:

- The cooling conditions: indoor temp.: 27°C DB, 19°C WB outdoor temp.: 35°C DB equivalent pipe length: 5m drop length: 0m.
- The heating conditions: indoor temp.: 20°C DB, 15°C WB outdoor temp.: 7°C DB equivalent pipe length: 5m drop length: 0m.
- Sound level: Anechoic chamber conversion value, measured at a point 1 m in front of the unit at a height of 1.2m. During actual operation, these values are normally somewhat higher as a result of ambient conditions.
- The above data may be changed without notice for future improvement on quality and performance.

Specifications 50Hz

Model			38VR003H112010	38VR004H11201S	38VR004H112010	38VR005H112010	38VR006H112010
Power supply		V-Ph-Hz	220-240V/1Ph~50Hz	220-240V/1Ph~50Hz	220-240V/1Ph~50Hz	220-240V/1Ph~50Hz	220-240V/1Ph~50Hz
Cooling	Capacity	kW	7.2 (1.5-8.0)	9.0 (2.0-10.0)	12.3	14	15.5
		RT	2.3	3.0	3.5	4.0	4.4
	Input	kW	1.85	2.30	3.25	3.95	4.52
	EER	KBtu/h/kW	13.31	13.38	12.90	12.08	11.70
Heating	Capacity	kW	7.2(1.6-8.4)	9.0(2.1-10.5)	13.2	15.4	17
		RT	2.6	3.3	3.8	4.4	4.9
	Input	kW	1.79	2.27	3.47	4.16	4.77
Coneectable indoor unit	COP	KBtu/h/kW	13.72	13.55	12.97	12.62	12.15
	Total capacity	%	50-130%	50-130%	50-130%	50-130%	50-130%
Outdoor sound level (sound pressure level)	Max.quantity		4	5	6	6	7
		dB(A)	56	57	57	57	57
Refrigerant Pipe	Liquid side	mm	Φ9.52	Φ9.52	Φ9.52	Φ9.52	Φ9.52
	Gas side	mm	Φ15.9	Φ15.9	Φ15.9	Φ15.9	Φ19.1
Compressor	Type		Rotary	Rotary	Rotary	Rotary	Rotary
	Brand		mitsubishi	mitsubishi	mitsubishi	mitsubishi	mitsubishi
	Capacity	Btu/h	24334	24334	33642	33642	47700
	Crankcase	W	25	25	25	25	25
	Refrigerant oil	ml	FV50S 670ml+200ml	FV50S 670ml+200ml	FV50S 870ml+630ml	FV50S 870ml+630ml	FV50S 1400ml+250ml
Fan motor	Quantities		1	1	2	2	2
	Type		DCmotor	DCmotor	DCmotor	DCmotor	DCmotor
	Brand		Panasonic	Panasonic	Panasonic	Panasonic	Panasonic
	Output	W	170	170	2*85	2*85	2*85
Air flow rate	m ³ /h		5500	5500	6000	6000	6000
	CFM		3235	3235	3529	3529	3529
Outdoor unit	Dimension(W*H*D)	mm	1075*966*396	1075*966*396	900*1327*400	900*1327*400	900*1327*400
	Packing (W*H*D)	mm	1120x1100x435	1120*1100*435	1030*1456*435	1030*1456*435	1030*1456*435
	Net/Gross weight	kg	75.5/85.5	75.5/85.5	95/106	95/106	100/111
Refrigerant	Type		R410A	R410A	R410A	R410A	R410A
	Charged volume	g	2800	3000	3300	3900	3900
Throttle type			EXV	EXV	EXV	EXV	EXV
Design pressure		MPa	4.4/2.6	4.4/2.6	4.4/2.6	4.4/2.6	4.4/2.6
Ambient temp	Cooling	°C	-15~43				
	Heating	°C	-15~27				

Mini H Series-Cooling Only 1 Phase

Specifications 50/60Hz

Model name		38VR003C11A010	38VR004C11A01S	38VR004C11A010	38VR005C11A010	38VR006C11A010	
Power supply	V-Ph-Hz	1-phase, 220-240V, 50Hz 1-phase, 208-230V, 60Hz					
Cooling ¹	Capacity	kW	7.2	9.2	11	14.5	17
	Power input	kW	1.64	2.13	2.75	3.57	4.24
	EER		4.39	4.32	4	4.06	4.26
Connected indoor units	Total capacity	45-130% of outdoor unit capacity					
	Maximum quantity		4	5	6	8	9
Compressor	Type	DC inverter					
	Quantity	1					
Fan motor	Motor Type	DC					
	Quantity	1					
Refrigerant	Type	R410A					
	Factory charging	kg	1.4	1.4	1.4	2.6	2.6
Pipe connections	Liquid pipe	mm	Φ9.53	Φ9.53	Φ9.53	Φ9.53	Φ9.53
	Gas pipe	mm	Φ15.9	Φ15.9	Φ15.9	Φ15.9	Φ15.9
Airflow rate		m ³ /h	3400	3400	3400	5100	5100
Sound pressure level ²		dB(A)	54	54	54	55	55
Net dimensions (WxHxD)		mm	973x862x302	973x862x302	973x862x302	1053x865x523	1053x865x523
Packed dimensions (WxHxD)		mm	1025x910x410	1025x910x410	1025x910x410	1120x890x560	1120x890x560
Net weight		kg	58	58	58	85	85
Gross weight		kg	63	63	63	92	92
Operating temperature range		°C	Cooling: -5 to 48				

Notes:

- Indoor air temperature 27°C (80.6 °F) DB, 19°C (66.2 °F) WB; outdoor air temperature 35°C (95 °F) DB; equivalent refrigerant piping length 7.5m (24.6ft.) with zero level difference.
- Sound pressure level is measured at a position 1m (3.28ft.) in front of the unit and 1.3m (4.26ft.) above the floor in a semi-anechoic chamber.
- For a system with more than one IDU, to ensure even distribution of refrigerant, the capacity of each indoor unit should not exceed 8kW.

Super XS Series - Heat Pump 1 Phase

Specifications 50/60Hz

HP		3		4		4.5		
Model		38VR003H112016		38VR0S4H112016		38VR004H112016		
Power supply	V/N/Hz	220-240/1/ 50(60)						
Cooling ¹	Capacity	kW	8.0		10.0		12.0	
		kBtu/h	27.3		34.1		40.9	
	Power input	kW	2		2.55		3.1	
	EER		4		3.92		3.87	
Heating ²	Capacity	kW	9.0		12.0		14.0	
		kBtu/h	30.7		40.9		47.8	
	Power input	kW	1.95		2.97		3.45	
	COP		4.62		4.04		4.06	
Connectable indoor unit	Total capacity	45~130% of outdoor unit capacity						
	Max. quantity		4		6		7	
Compressor	Type	DC inverter						
	Quantity	1						
Fan motor	Type	DC						
	Quantity	1						
Refrigerant	Type	R410A						
	Factory charge	kg	2.2		2.35		3	
Pipe connections ³	Liquid pipe	mm	Φ9.53		Φ9.53		Φ9.53	
	Gas pipe	mm	Φ15.9		Φ15.9		Φ15.9	
Airflow rate		m ³ /h	3700		5200		5000	
Sound pressure level		dB(A)	54		54		56	
Net dimensions (WxHxD)		mm	982x712x440		950x840x426		950x840x426	
Packed dimensions (WxHxD)		mm	1048x810x485		1025x950x510		1025x950x510	
Net weight		kg	53		71.5		83	
Gross weight		kg	57.5		81		92	
Operating temperature range		°C	Cooling: -5~55, Heating: -15~27					

HP		5		6		
Model		38VR005H112016		38VR006H112016		
Power supply	V/N/Hz	220-240/1/ 50(60)				
Cooling ¹	Capacity	kW	14.0		15.5	
		kBtu/h	47.8		52.9	
	Power input	kW	3.75		4.8	
	EER		3.73		3.23	
Heating ²	Capacity	kW	16.0		18.0	
		kBtu/h	54.6		61.4	
	Power input	kW	3.85		4.65	
	COP		4.16		3.87	
Connectable indoor unit	Total capacity	45~130% of outdoor unit capacity				
	Max. quantity		8		9	
Compressor	Type	DC inverter				
	Quantity	1				
Fan motor	Type	DC				
	Quantity	1				
Refrigerant	Type	R410A				
	Factory charge	kg	3.4		3.8	
Pipe connections ³	Liquid pipe	mm	Φ9.53		Φ9.53	
	Gas pipe	mm	Φ15.9		Φ19.1	
Airflow rate		m ³ /h	5400		5200	
Sound pressure level		dB(A)	56		56	
Net dimensions (WxHxD)		mm	1040x865x523			
Packed dimensions (WxHxD)		mm	1120x980x560			
Net weight		kg	90.4		94.4	
Gross weight		kg	100.4		104.4	
Operating temperature range		°C	Cooling: -5~55, Heating: -15~27			

Notes:

- Indoor temperature 27°C DB, 19°C WB; outdoor temperature 35°C DB; equivalent refrigerant piping length 7.5m with zero level difference.
- Indoor temperature 20°C DB; outdoor temperature 7°C DB, 6°C WB; equivalent refrigerant piping length 7.5m with zero level difference.
- Sound pressure level is measured at a position 1m in front of the unit and 1m above the floor in a semi-anechoic chamber.

Super XS Series-Heat Pump 3 Phase

■ Specifications 50/60Hz

HP			7	8	9	10	12
Model			38VR007H119016	38VR008H119016	38VR009H119016	38VR010H119016	38VR012H119016
Power supply	V/N/Hz	380-415/3/50(60)					
Cooling ¹	Capacity	kW	20	22.4	26	28.5	33.5
		kBtu/h	68.2	76.4	88.7	97.2	114.3
	Power input	kW	5.6	6.3	7.6	8.4	9.2
	EER		3.57	3.56	3.42	3.39	3.64
Heating ² (Nominal)	Capacity	kW	20	22.4	26	28.5	33.5
		kBtu/h	68.2	76.4	88.7	97.2	114.3
	Power input	kW	4.7	5.3	6.6	7.3	8.1
	COP		4.26	4.23	3.94	3.9	4.14
Heating ² (Max)	Capacity	kW	22.5	25	28.5	31.5	37.5
		kBtu/h	76.8	85.3	97.2	107.5	128.0
	Power input	kW	5.4	6	7.3	8.1	9.2
	COP		4.17	4.17	3.9	3.89	4.08
Connected indoor unit	Total capacity	50-130% of outdoor unit capacity					
	Maximum quantity		11	13	15	16	20
Compressor	Type	DC inverter					
	Quantity	1					
Fan motors	Type	DC					
	Quantity	2					
Refrigerant	Type	R410A					
	Factory charge	kg	6.5	6.5	6.5	6.5	8
Pipe connections ³	Liquid pipe	mm	Φ9.53	Φ9.53	Φ9.53	Φ9.53	Φ12.7
	Gas pipe	mm	Φ19.1	Φ19.1	Φ22.2	Φ22.2	Φ25.4
Airflow rate		m ³ /h	9000	9000	10000	11000	11300
Sound pressure level ⁴		dB(A)	58	58	59	60	61
Net dimensions (WxHxD)		mm	1120x1558x528				
Packed dimensions (WxHxD)		mm	1270x1720x565				
Net weight		kg	143	144	144	144	157
Gross weight		kg	159	160	160	160	173
Operating temperature range	Cooling	°C	-5 to 55				
	Heating	°C	-20 to 24				

Notes:

- Indoor temperature 27°C DB, 19°C WB; outdoor temperature 35°C DB; equivalent refrigerant piping length 7.5m with zero level difference.
- Indoor temperature 20°C DB; outdoor temperature 7°C DB, 6°C WB; equivalent refrigerant piping length 7.5m with zero level difference.
- Diameters given are those of the unit's stop valves.
- Sound pressure level is measured at a position 1m in front of the unit and 1m above the floor in a semi-anechoic chamber.

Super XS Series – Cooling Only 3 Phase

■ Specifications 50/60Hz

HP			7	8	9	10	
Model			38VR007C119016	38VR008C119016	38VR009C119016	38VR010C119016	
Power supply	V/N/Hz	380-415/3/50					
Cooling ¹	Capacity	kW	20.0	22.4	26.0	28.0	
		kBtu/h	68.2	76.4	88.7	95.5	
	Power Input	kW	5.13	5.93	7.43	8.24	
EER		3.9	3.78	3.5	3.4		
Connected indoor unit	Total Capacity	50-130% of outdoor unit capacity					
	Maximum Quantity		10	13	15	16	
Compressor	Type	DC inverter					
	Quantity	1					
Fan	Type	AC					
	Quantity	2					
Refrigerant	Type	R410A					
	Factory charging	kg	3.9				
Pipe connections	Liquid pipe	mm	Φ9.53				
	Gas pipe	mm	Φ19.1				
Airflow rate		m ³ /h	7150				
Sound pressure level ²		dB(A)	57	57	58	59	
Net dimensions (WxHxD)		mm	902x1327x370				
Packed dimensions (WxHxD)		mm	1030x1456x435				
Net weight		kg	115				
Gross weight		kg	125				
Operating temperature range		°C	-5 ~ 55				

HP			7	8	9	10	
Model			38VR007C118016	38VR008C118016	38VR009C118016	38VR010C118016	
Power supply	V/N/Hz	380-415/3/60					
Cooling ¹	Capacity	kW	20.0	22.4	26.0	28.0	
		kBtu/h	68.2	76.4	88.7	95.5	
	Power Input	kW	5.13	5.93	7.43	8.24	
EER		3.9	3.78	3.5	3.4		
Connected indoor unit	Total Capacity	50-130% of outdoor unit capacity					
	Maximum Quantity		10	13	15	16	
Compressor	Type	DC inverter					
	Quantity	1					
Fan	Type	AC					
	Quantity	2					
Refrigerant	Type	R410A					
	Factory charging	kg	3.9				
Pipe connections	Liquid pipe	mm	Φ9.53				
	Gas pipe	mm	Φ19.1				
Airflow rate		m ³ /h	7150				
Sound pressure level ²		dB(A)	58	58	59	60	
Net dimensions (WxHxD)		mm	902x1327x370				
Packed dimensions (WxHxD)		mm	1030x1456x435				
Net weight		kg	115				
Gross weight		kg	125				
Operating temperature range		°C	-5 ~ 55				

Notes:

- Indoor temperature 27°C DB, 19°C WB; outdoor temperature 35°C DB; equivalent refrigerant piping length 7.5m with zero level difference.
- Sound pressure level is measured at a position 1m in front of the unit and 1m above the floor in a semi-anechoic chamber.

Dimension

Mini H Series unit Heat Pump 8/10.5kW

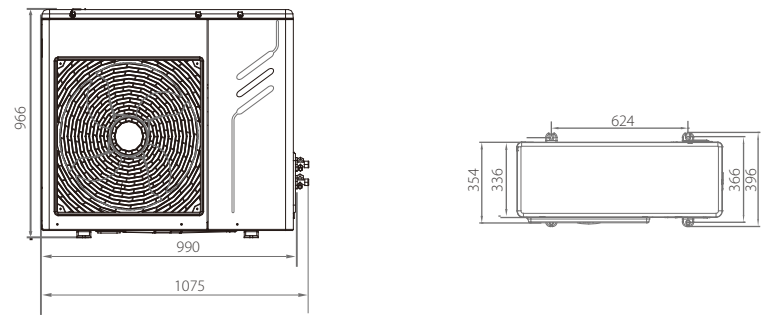

Mini H Series-Cooling Only

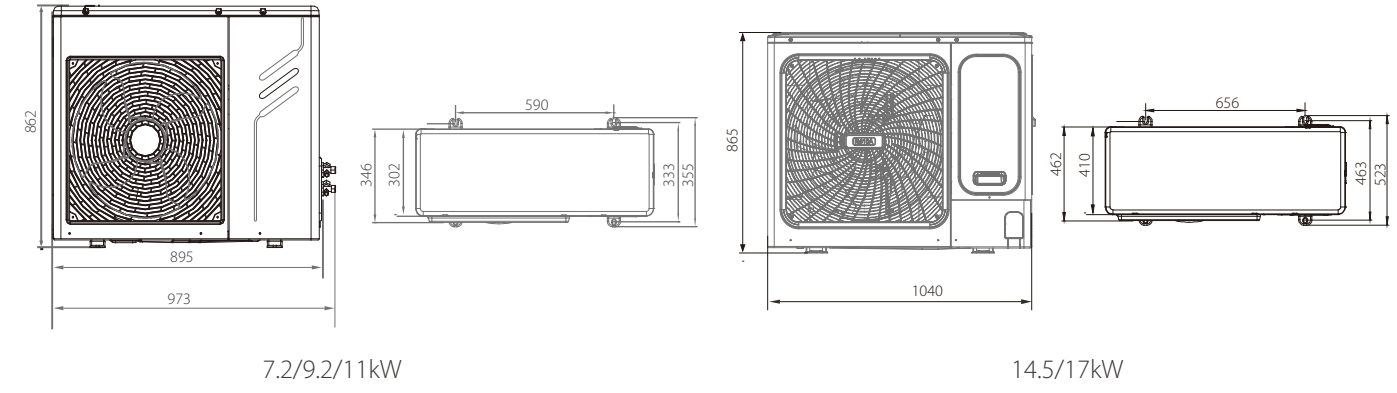

12/14/15.5/17.5kW

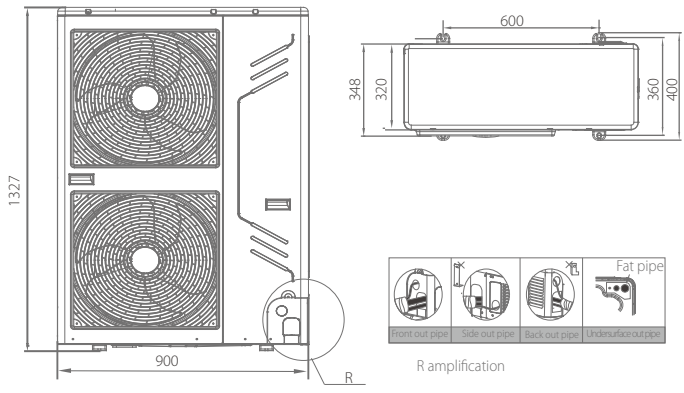

20/22.4/26/28/33.5kW

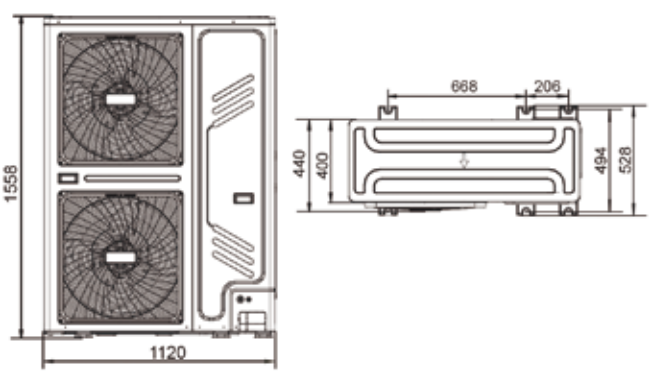

Super XS-Heat Pump

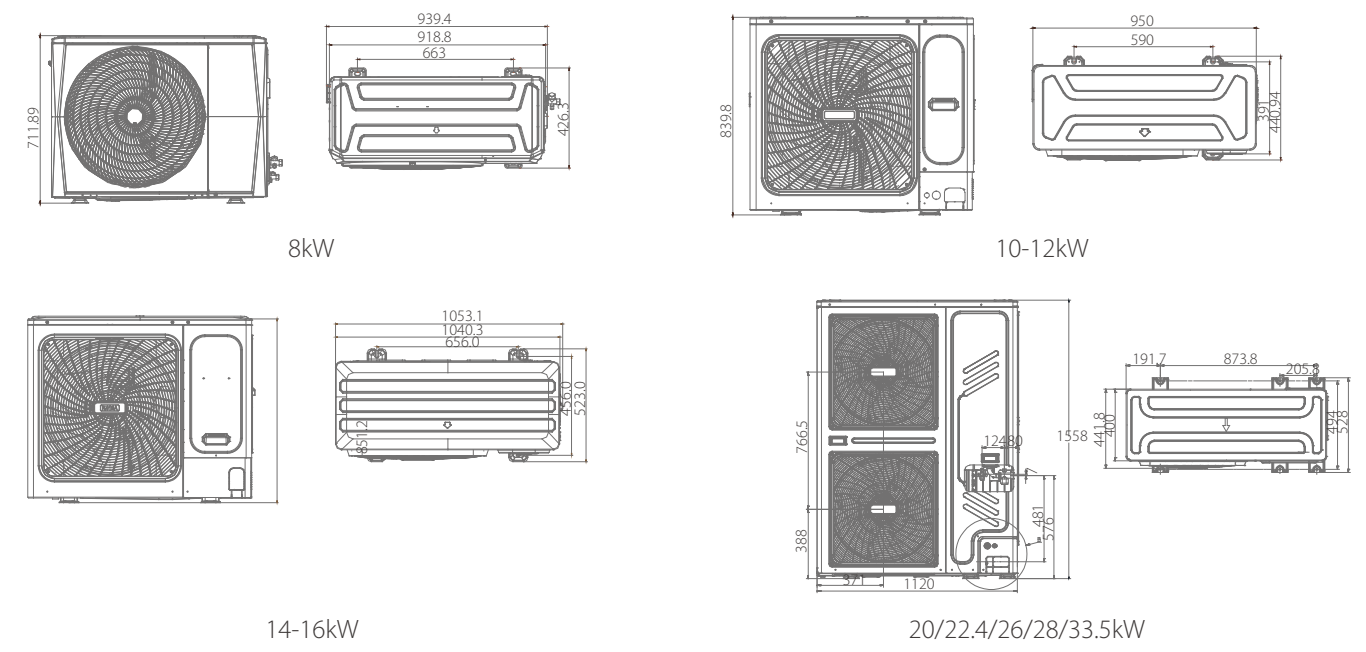

40/45kW

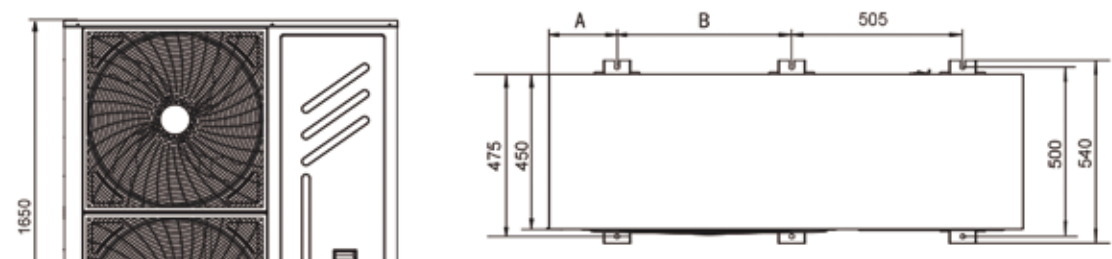
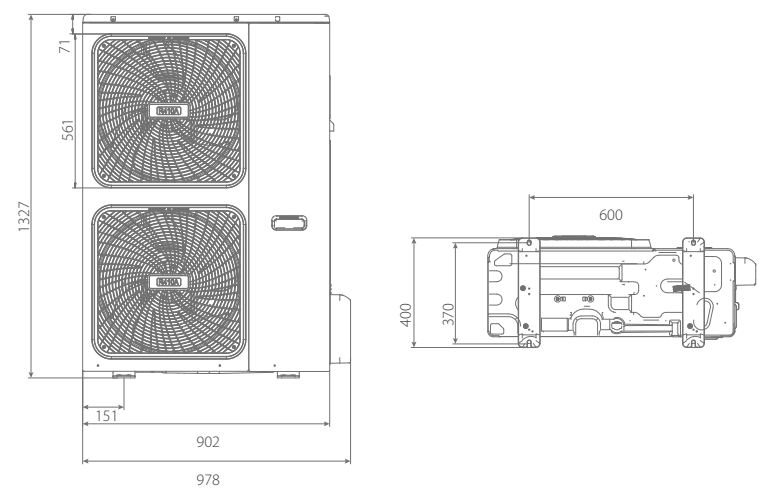
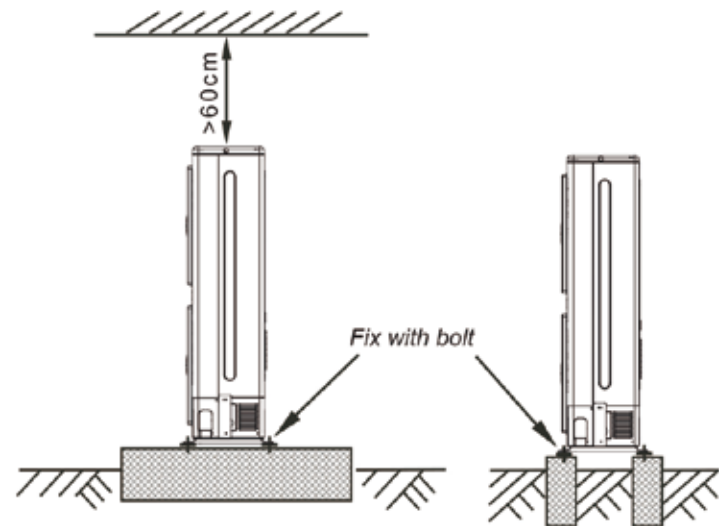

Table 4-1

Model \ Size	A	B	C
40kW	175	505	1360
45kW	225	555	1460

Super XS-Cooling Only





- Single unit installation

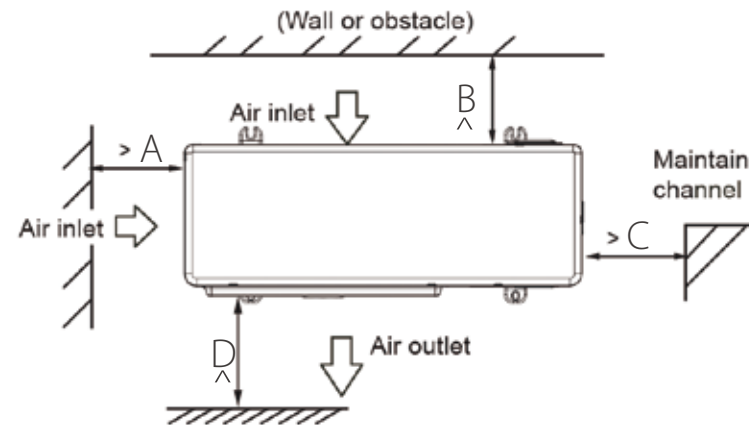

- Parallel connect the two units or above

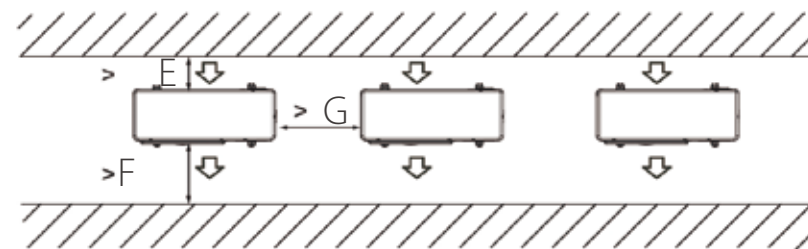

- Parallel connect the front with rear sides

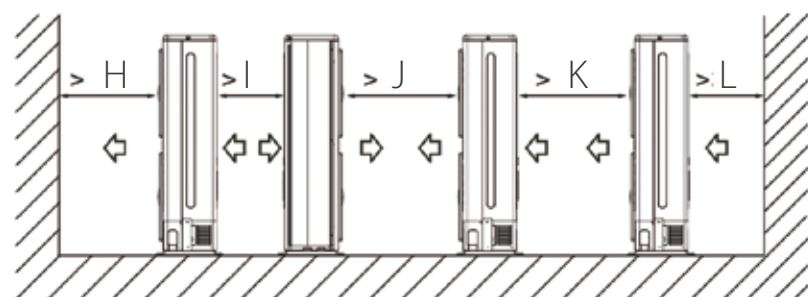

Model (kW)	A	B	C	D	E	F	G	H	I	G	K	L
8-18kW	300	300	600	2000	300	2000	600	2000	500	3000	3000	300
20-33.5kW	300	300	600	3000	300	3000	600	3000	1000	6000	4000	300
40-45kW	400	400	600	4000	400	4000	600	4000	1000	8000	6000	400

2nd Generation VRF DC INDOOR UNITS

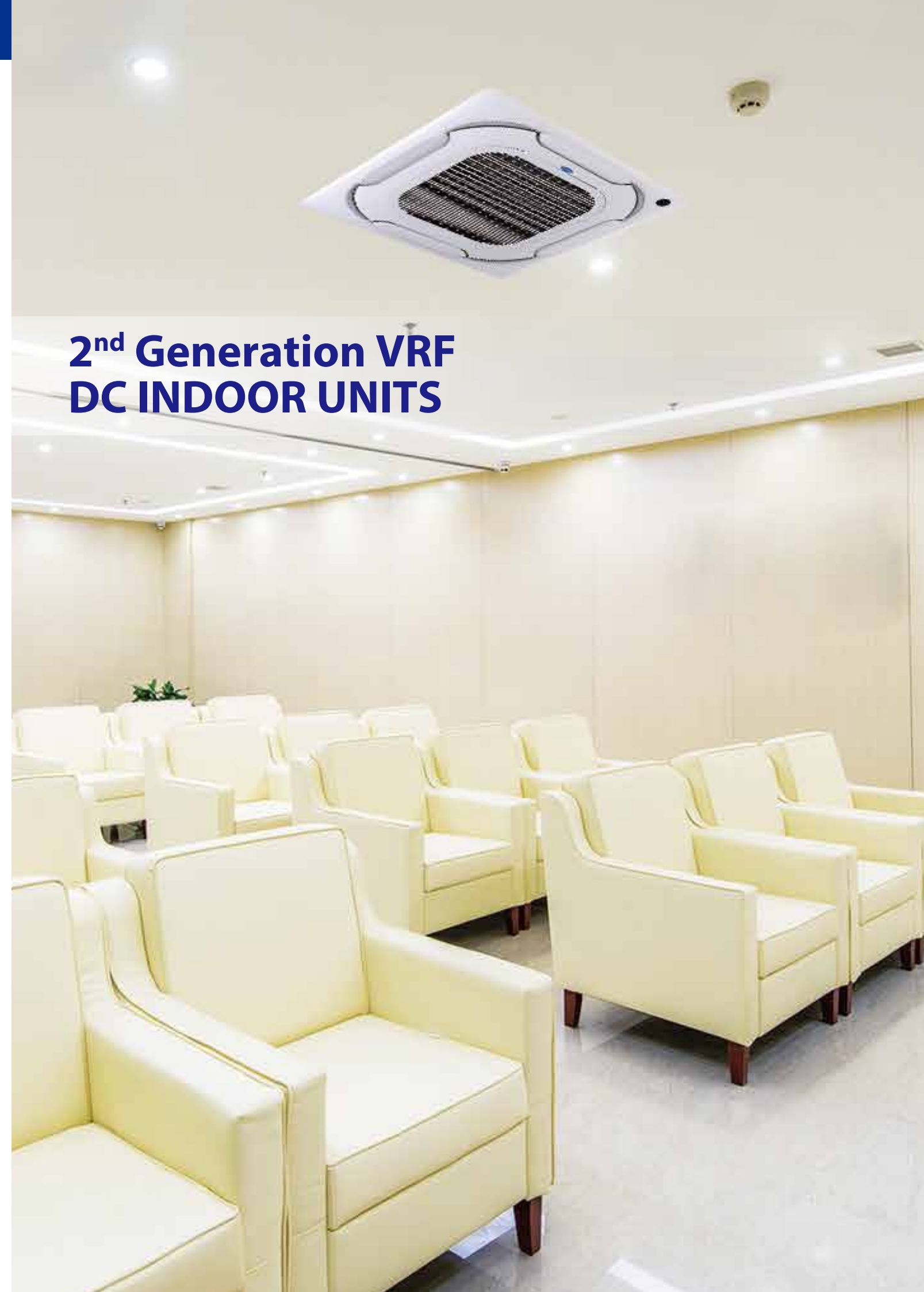

Wide Application Range

Wide Range of Indoor Units

With 11 types and more than 100 models, Carrier VRF indoor units meet varied customer requirements in a wide range of locations including shopping malls, hospitals, office buildings, hotels and airports.



Multiple Appearance Options

For Four-way Cassette and Compact Four-way Cassette Units, interchangeable 360° airflow and four-way airflow panels are available.



360° airflow



Four-way airflow

For Floor Standing Units, the concealed unit is designed to be concealed in walls while the front air intake and underside air intake offer a choice of air intake options.



Concealed



Front air intake



Underside air intake

Comfort and Efficiency

High Efficiency DC Fan Motor

The power consumption of DC fan motor can be reduced greatly in comparison to corresponding AC type.



Quiet Operation

The low sound operation DC fan motor and optimized fan blades guarantees the air discharge smoothly and provides a quiet living environment.



Constant Level of Indoor Air Temperature

Plate Heat Exchanger as a secondary intercooler to gain up to 18°C subcooling and improves 10% energy efficiency.

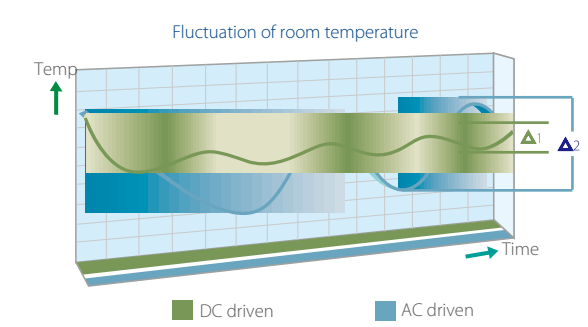

5-step Swing Louver

The air is comfortably spread upwards and downwards thanks to the 5-step swing louver that can be programmed via the controller.

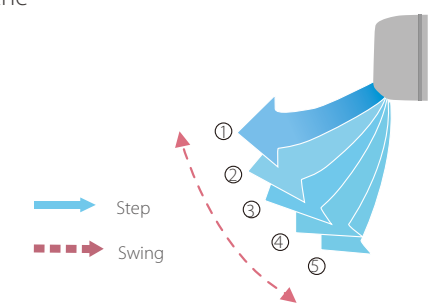

Comfort and Efficiency

Static Pressure 20 Steps Control (Duct Unit)

Depending on the installation environment, medium static pressure duct is controlled the static pressure up to 10 steps and high static pressure duct is controlled the static pressure up to 20 steps via wired remote controller, for providing comfortable environment suitable for any environment.

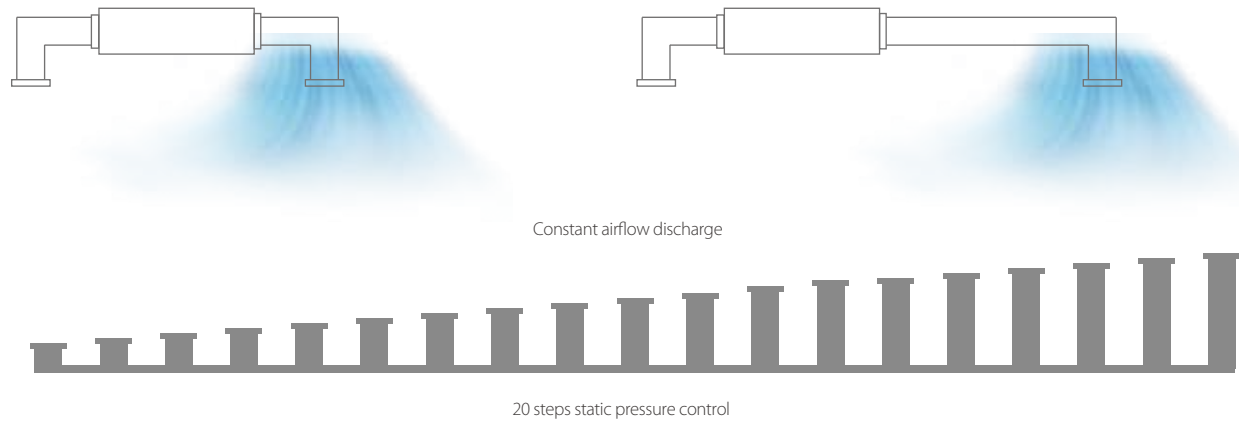

7-Speed Fan Control

7 indoor fan speeds provide control flexibility to meet the needs of different indoor conditions.

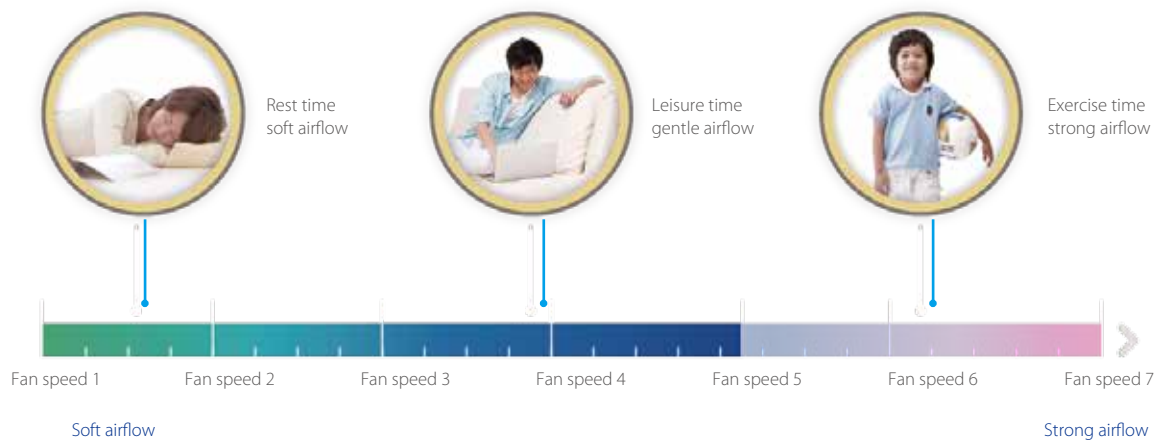

Fresh Air Intake

On selected models, a reserved outside air intake port allows outdoor air to be introduced directly into the unit, negating the need for a separate ventilation system.

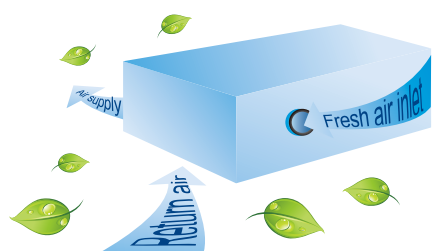

Convenience

High-lift Drain Pump

A drain pump with a 750mm or 500mm pump head is fitted as standard or optional, simplifying installation of the drain piping.

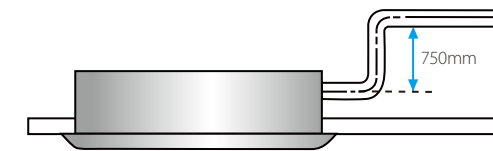

Flexible Installation

For Medium Static Pressure Duct Units, to provide the flexibility to adapt to differing installation situations, the air inlet may be positioned either on the underside or the rear of the unit.

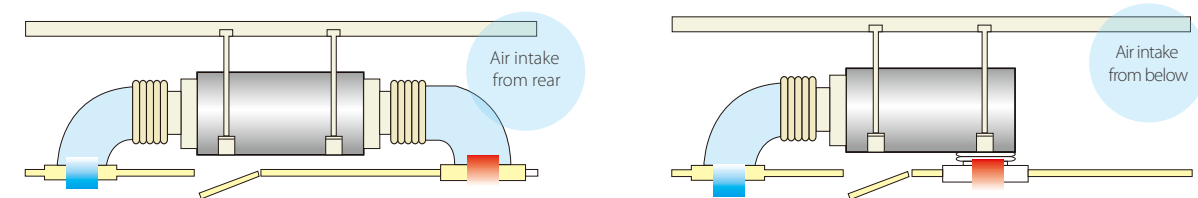

For Wall Mounted Units, the refrigerant outlet direction can be left, right or rear as the installation situation requires. A new fixing plate design speeds installation and provides extra stability.

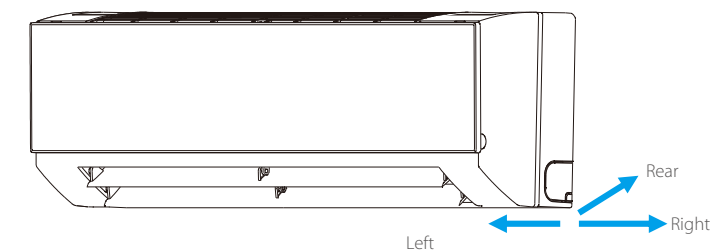

Ceiling / Floor Units can be installed either on the ceiling or the floor, providing flexibility to accommodate a wide range of room designs.

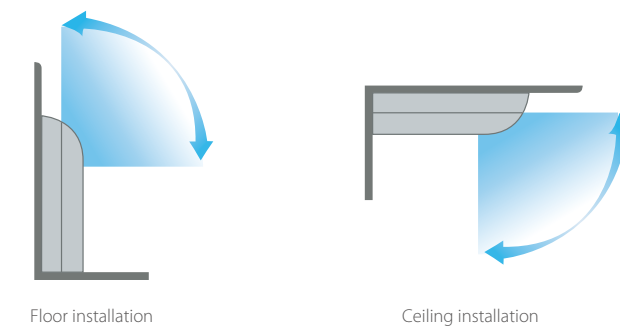

One-way Cassette

- Fresh air intake (4.5-7.1kW)
- One-way air discharge, ideal for corner locations
- Drain pump with 750mm pump head fitted as standard



Standard controller

Optional controller



WL-12B-CM



WL-12F-CM



WR-86KD-CM



WR-120G-CM

Model			40VZ006H11500016	40VZ007H11500016	40VZ009H11500016	40VZ012H11500016
Power supply			1-phase, 220-240V, 50/60Hz			
Cooling ¹	Capacity	kW	1.8	2.2	2.8	3.6
		kBtu/h	6.1	7.5	9.6	12.3
	Power input	W	25	25	30	30
Heating ²	Capacity	kW	2.2	2.6	3.2	4.0
		kBtu/h	7.5	8.9	10.9	13.6
	Power input	W	25	25	30	30
Air flow rate ³	m ³ /h	380/355/330/300/286/263/240			460/440/410/380/355/330/300	
Sound pressure level ⁴	dB(A)	30/28/27/26/25/24/22			37/36/35/34/32/31/30	38/37/35/34/32/31/30
Main body	Net dimensions ⁵ (WxHxD)	mm	1054x153x425			
	Packed dimensions (WxHxD)	mm	1155x245x490			
	Net/Gross weight	kg	11.8/15.3		12.3/15.8	
Panel	Net dimensions (WxHxD)	mm	1180x25x465			
	Packed dimensions (WxHxD)	mm	1232x107x517			
	Net/Gross weight	kg	3.5/5.2			
Pipe connections	Liquid/Gas pipe	mm	Φ6.35/Φ12.7			
	Drain pipe	mm	OD Φ32			

Model			40VZ016H11500016	40VZ020H11500016	40VZ024H11500016
Power supply			1-phase, 220-240V, 50/60Hz		
Cooling ¹	Capacity	kW	4.5	5.6	7.1
		kBtu/h	15.4	19.1	24.2
	Power input	W	40	48	60
Heating ²	Capacity	kW	5.0	6.3	8.0
		kBtu/h	17.1	21.5	27.3
	Power input	W	40	48	60
Air flow rate ³	m ³ /h	693/662/638/600/556/510/476		792/763/728/688/643/589/549	933/873/815/749/689/637/592
Sound pressure level ⁴	dB(A)	39/37/36/35/34/32/31		41/39/38/37/36/35/33	43/41/40/39/37/36/35
Main body	Net dimensions ⁵ (WxHxD)	mm	1275x189x450		
	Packed dimensions (WxHxD)	mm	1370x295x505		
	Net/Gross weight	kg	16.1/20.4	16.4/20.7	17.6/22.4
Panel	Net dimensions (WxHxD)	mm	1350x25x505		
	Packed dimensions (WxHxD)	mm	1410x95x560		
	Net/Gross weight	kg	4/5.4		
Pipe connections	Liquid/Gas pipe	mm	Φ6.35/Φ12.7		Φ9.53/Φ15.9
	Drain pipe	mm	OD Φ32		

Notes:

1. Indoor temperature 27°C DB, 19°C WB; outdoor temperature 35°C DB; equivalent refrigerant piping length 7.5m with zero level difference.
2. Indoor temperature 20°C DB; outdoor temperature 7°C DB, 6°C WB; equivalent refrigerant piping length 7.5m with zero level difference.
3. Each model's 7 airflow rate options are listed in order, from highest to lowest.
4. Each model's 7 sound pressure levels are listed in order from highest to lowest and correspond to the model's 7 airflow rate options (see Note 3). Sound pressure level is measured 1.4m below the unit in a semi-anechoic chamber.
5. Unit body dimensions given are the largest external dimensions of the unit, including hanger attachments.

Two-way Cassette

- Two-way air discharge, perfect for limited ceiling space applications
- Drain pump with 750mm pump head fitted as standard
- Fresh air intake

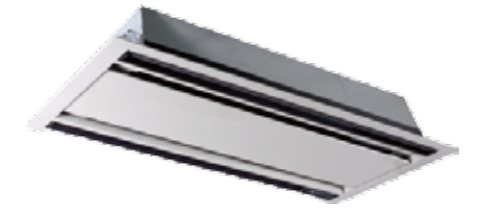

Standard controller

Optional controller



WL-12B-CM



WL-12F-CM



WR-86KD-CM



WR-120G-CM

Model			40VT007H11500016	40VT009H11500016	40VT012H11500016
Power supply			1-phase, 220-240V, 50/60Hz		
Cooling ¹	Capacity	kW	2.2	2.8	3.6
		kBtu/h	7.5	9.6	12.3
	Power input	W	35	40	40
Heating ²	Capacity	kW	2.6	3.2	4.0
		kBtu/h	8.9	10.9	13.6
	Power input	W	35	40	40
Air flow rate ³	m ³ /h	654/612/571/530/488/449/410		654/612/571/530/488/449/410	725/679/641/591/554/509/458
Sound pressure level ⁴	dB(A)	33/31/30/29/27/25/24		33/31/30/29/27/25/24	35/33/32/30/29/27/25
Main body	Net dimensions ⁵ (WxHxD)	mm	1172x299x591		
	Packed dimensions (WxHxD)	mm	1355x400x675		
	Net/Gross weight	kg	33.5/42.0		
Panel	Net dimensions (WxHxD)	mm	1430x53x680		
	Packed dimensions (WxHxD)	mm	1525x130x765		
	Net/Gross weight	kg	10.5/15		
Pipe connections	Liquid/Gas pipe	mm	Φ6.35/Φ12.7		
	Drain pipe	mm	OD Φ32		

Model			40VT016H11500016	40VT020H11500016	40VT024H11500016
Power supply			1-phase, 220-240V, 50/60Hz		
Cooling ¹	Capacity	kW	4.5	5.6	7.1
		kBtu/h	15.4	19.1	24.2
	Power input	W	50	69	98
Heating ²	Capacity	kW	5.0	6.3	8.0
		kBtu/h	17.1	21.5	27.3
	Power input	W	50	69	98
Air flow rate ³	m ³ /h	850/792/731/670/631/592/550		980/925/855/800/755/702/670	1200/1115/1068/1000/921/808/770
Sound pressure level ⁴	dB(A)	37/36/35/34/32/31/30		39/37/36/35/33/31/30	44/42/41/40/38/36/34
Main body	Net dimensions ⁵ (WxHxD)	mm	1172x299x591		
	Packed dimensions (WxHxD)	mm	1355x400x675		
	Net/Gross weight	kg	35/43.5		
Panel	Net dimensions (WxHxD)	mm	1430x53x680		
	Packed dimensions (WxHxD)	mm	1525x130x765		
	Net/Gross weight	kg	10.5/15		
Pipe connections	Liquid/Gas pipe	mm	Φ6.35/Φ12.7		Φ9.53/Φ15.9
	Drain pipe	mm	OD Φ32		

Notes:

1. Indoor temperature 27°C DB, 19°C WB; outdoor temperature 35°C DB; equivalent refrigerant piping length 7.5m with zero level difference.
2. Indoor temperature 20°C DB; outdoor temperature 7°C DB, 6°C WB; equivalent refrigerant piping length 7.5m with zero level difference.
3. Each model's 7 airflow rate options are listed in order, from highest to lowest.
4. Each model's 7 sound pressure levels are listed in order from highest to lowest and correspond to the model's 7 airflow rate options (see Note 3). Sound pressure level is measured 1.4m below the unit in a semi-anechoic chamber.
5. Unit body dimensions given are the largest external dimensions of the unit, including hanger attachments.

Compact Four-way Cassette

360° airflow allows for even, wide-range cooling and heating
 Drain pump with 500mm pump head fitted as standard



Model	40VX007H11500016	40VX009H11500016	40VX012H11500016	40VX016H11500016		
Power supply	1-phase, 220-240V, 50/60Hz					
Cooling ¹	Capacity	kW	2.2	2.8	3.6	4.5
		kBtu/h	7.5	9.6	12.3	15.4
	Power input	W	35	35	40	50
Heating ²	Capacity	kW	2.4	3.2	4.0	5.0
		kBtu/h	8.2	10.9	13.6	17.1
	Power input	W	35	35	40	50
Air flow rate ³	m ³ /h	414/380/345/313/288/268/238		521/485/450/409/380/350/314		
Sound pressure level ⁴	dB(A)	35/34/33/29/26/23/22		41/38/35/32/30/29/28		
Main body	Net dimensions ⁵ (WxHxD)	mm	630x260x570			
	Packed dimensions (WxHxD)	mm	700x345x660			
	Net/Gross weight	kg	18/23.8	19.2/25.0		
Panel	Net dimensions (WxHxD)	mm	647x50x647			
	Packed dimensions (WxHxD)	mm	715x123x715			
	Net/Gross weight	kg	2.5/4.5			
Pipe connections	Liquid/Gas pipe	mm	Φ6.35/Φ12.7			
	Drain pipe	mm	OD Φ25			

Notes:
 1. Indoor temperature 27°C DB, 19°C WB; outdoor temperature 35°C DB; equivalent refrigerant piping length 7.5m with zero level difference.
 2. Indoor temperature 20°C DB; outdoor temperature 7°C DB, 6°C WB; equivalent refrigerant piping length 7.5m with zero level difference.
 3. Each model's 7 airflow rate options are listed in order, from highest to lowest.
 4. Each model's 7 sound pressure levels are listed in order from highest to lowest and correspond to the model's 7 airflow rate options (see Note 3). Sound pressure level is measured 1.4m below the unit in a semi-anechoic chamber.
 5. Unit body dimensions given are the largest external dimensions of the unit, including hanger attachments.

Four-way Cassette

- Fresh air intake
- Four-way airflow, allows wide-angle, equal distribution of cooling and heating
- Drain pump with 750mm pump head fitted as standard
- Brand-new, elegant panel with four independently controlled louvers



40VK***H11500016



40VK***H11500016(i)
 louvers can be controlled independently



Model	40VK009H11500016	40VK012H11500016	40VK016H11500016	40VK020H11500016	40VK024H11500016		
Power supply	1 phase, 220-240V, 50/60Hz						
Cooling ¹	Capacity	kW	2.8	3.6	4.5	5.6	7.1
		kBtu/h	9.6	12.3	15.4	19.1	24.2
	Power input	W	40	45	50	60	70
Heating ²	Capacity	kW	3.2	4.0	5.0	6.3	8.0
		kBtu/h	10.9	13.6	17.1	21.5	27.3
	Power input	W	40	45	50	60	70
Air flow rate ³	m ³ /h	801/751/711/658/637/611/542	801/751/711/658/637/611/542	893/866/804/744/714/698/635	893/866/804/744/714/698/635	977/937/864/800/778/738/671	
Sound pressure level ⁴	dB(A)	32/31/30/28/28/26/23		35/34/31/31/30/28/26		35/35/34/31/30/28/27	
Main body	Net dimensions ⁵ (WxHxD)	mm	840x230x840				
	Packed dimensions (WxHxD)	mm	955x260x955				
	Net/Gross weight	kg	21.3/25.8		23.2/27.6		
Panel	Net dimensions (WxHxD)	mm	950x54.5x950				
	Packed dimensions (WxHxD)	mm	1035x90x1035				
	Net/Gross weight	kg	5.5/8.2				
Pipe connections	Liquid/Gas pipe	mm	Φ6.35/Φ12.7		Φ9.53/Φ15.9		
	Drain pipe	mm	OD Φ32				

Model	40VK028H11500016	40VK030H11500016	40VK034H11500016	40VK036H11500016	40VK048H11500016	40VK060H11500016		
Power supply	1 phase, 220-240V, 50/60Hz							
Cooling ¹	Capacity	kW	8.0	9.0	10.0	11.2	14.0	16.0
		kBtu/h	27.3	30.7	34.1	38.2	47.8	54.5
	Power input	W	96	100	150	160	170	94
Heating ²	Capacity	kW	9.0	10.0	11.0	12.5	16.0	17.0
		kBtu/h	30.7	34.1	37.5	42.7	54.6	61.3
	Power input	W	96	100	150	160	170	170
Air flow rate ³	m ³ /h	1203/1131/1064/977/912/840/774	1349/1294/1230/1201/1111/1029/970	1600/1530/1380/1250/1200/1150/1100	1700/1600/1440/1250/1200/1150/1100	1800/1650/1500/1300/1250/1200/1150	2100/1950/1800/1750/1600/1450/1350	
Sound pressure level ⁴	dB(A)	36/35/34/31/31/29/28	37/35/34/31/31/30/28	43/42/40/38/37/35/34		45/44/42/41/40/39/37	46/44/42/41/39/38/37	
Main body	Net dimensions ⁵ (WxHxD)	mm	840x230x840	840x300x840			950x300x950	
	Packed dimensions (WxHxD)	mm	955x260x955	955x330x955			1050x335x1050	
	Net/Gross weight	kg	23.2/27.6	28.4/33.8		30.7/35.8	35.3/41.2	
Panel	Net dimensions (WxHxD)	mm	950x54.5x950				1050x55x1050	
	Packed dimensions (WxHxD)	mm	1035x90x1035				1115x100x1115	
	Net/Gross weight	kg	5.5/8.2				7.4/9.7	
Pipe connections	Liquid/Gas pipe	mm	Φ9.53/Φ15.9					
	Drain pipe	mm	OD Φ32					

Notes:
 1. Indoor temperature 27°C DB, 19°C WB; outdoor temperature 35°C DB; equivalent refrigerant piping length 7.5m with zero level difference.
 2. Indoor temperature 20°C DB; outdoor temperature 7°C DB, 6°C WB; equivalent refrigerant piping length 7.5m with zero level difference.
 3. Each model's 7 airflow rate options are listed in order, from highest to lowest.
 4. Each model's 7 sound pressure levels are listed in order from highest to lowest and correspond to the model's 7 airflow rate options (see Note 3). Sound pressure level is measured 1.4m below the unit in a semi-anechoic chamber.
 5. Unit body dimensions given are the largest external dimensions of the unit, including hanger attachments.

Medium Static Pressure Duct

- Fresh air intake
- 6-step static pressure control on 2.2kW to 7.1kW models and 10-step static pressure control on 8kW to 14kW units (requires latest generation wired controllers)
- Drain pump with 750mm pump head fitted as standard
- Flexible installation for the air inlet may be positioned either on the underside or the rear of the unit



Optional controller



WL-12B-CM WL-12F-CM WR-86KD-CM WR-120G-CM

Model		42VD007H115003016		42VD009H115003016		42VD012H115003016		
Power supply		1 phase, 220-240V, 50/60Hz						
Cooling ¹	Capacity	kW	2.2	2.8	3.6			
		kBtu/h	7.5	9.6	12.3			
Power input		W	40	40	45			
Heating ²	Capacity	kW	2.6	3.2	4.0			
		kBtu/h	8.2	10.9	13.6			
Power input		W	40	40	45			
Air flow rate ³	m ³ /h	520/480/440/400/360/330/300				580/540/500/460/430/400/370		
External static pressure	Pa	10 (0~50)						
Sound pressure level ⁴	dB(A)	32/31/29/28/26/25/23				33/32/31/30/28/27/25		
Unit	Net dimensions ⁵ (WxHxD)	mm	780x210x500				870x285x525	
	Packed dimensions (WxHxD)	mm	18/21					
	Net/Gross weight	kg						
	Liquid/Gas pipe	mm	Φ6.35/Φ12.7					
Pipe connections	Drain pipe	mm	OD Φ25					

Model		42VD016H115003016		42VD020H115003016		42VD024H115003016		
Power supply		1 phase, 220-240V, 50/60Hz						
Cooling ¹	Capacity	kW	4.5	5.6	7.1			
		kBtu/h	15.4	19.1	24.2			
Power input		W	92	92	98			
Heating ²	Capacity	kW	5.0	6.3	8.0			
		kBtu/h	17.1	21.5	27.3			
Power input		W	92	92	98			
Air flow rate ³	m ³ /h	800/740/680/620/540/480/400		830/760/720/680/640/600/560		1000/960/900/840/780/720/680		
External static pressure	Pa	10 (0~50)						
Sound pressure level ⁴	dB(A)	36/34/32/31/29/27/25		36/34/33/32/30/29/28		37/35/33/32/30/29/28		
Unit	Net dimensions ⁵ (WxHxD)	mm	1000x210x500				1220x210x500	
	Packed dimensions (WxHxD)	mm	1115x285x525				1335x285x525	
	Net/Gross weight	kg	21.5/25				25.7/30.2	
	Liquid/Gas pipe	mm	Φ6.35/Φ12.7		Φ9.53/Φ15.9			
Pipe connections	Drain pipe	mm	OD Φ25					

Model		42VD028H115003016		42VD030H115003016		42VD036H115003016		42VD048H115003016		42VD060H115003016		
Power supply		1 phase, 220-240V, 50/60Hz										
Cooling ¹	Capacity	kW	8.0	9.0	11.2	14.0	16.0					
		kBtu/h	27.3	30.7	38.2	47.8	54.6					
Power input		W	110	120	200	250	250					
Heating ²	Capacity	kW	9.0	10.0	12.5	15.5	18.0					
		kBtu/h	30.7	34.1	42.7	52.9	61.4					
Power input		W	110	120	200	250	250					
Air flow rate ³	m ³ /h	1260/1180/1100/1020/940/860/780			1500/1430/1360/1290/1210/1140/1080		1960/1860/1760/1660/1560/1460/1360		2300/2100/2000/1900/1750/1600/1450			
External static pressure	Pa	20 (10~100)										
Sound pressure level ⁴	dB(A)	37/35/34/33/31/29/28			39/38/38/37/36/35/33		41/39/38/37/36/35/33		42/41/39/38/37/35/34			
Unit	Net dimensions ⁵ (WxHxD)	mm	1230x270x775				1290x300x865		1490x300x865			
	Packed dimensions (WxHxD)	mm	1355x350x795				1400x375x925		1605x345x955			
	Net/Gross weight	kg	36.5/44.5		37/45		46.5/55.5		54/63			
	Liquid/Gas pipe	mm	Φ9.53/Φ15.9									
Pipe connections	Drain pipe	mm	OD Φ25									

Notes:
 1. Indoor temperature 27°C DB, 19°C WB; outdoor temperature 35°C DB; equivalent refrigerant piping length 7.5m with zero level difference.
 2. Indoor temperature 20°C DB; outdoor temperature 7°C DB, 6°C WB; equivalent refrigerant piping length 7.5m with zero level difference.
 3. Each model's 7 airflow rate options are listed in order, from highest to lowest.
 4. Each model's 7 sound pressure levels are listed in order from highest to lowest and correspond to the model's 7 airflow rate options (see Note 3). Sound pressure level is measured 1.4m below the unit in a semi-anechoic chamber.
 5. Unit body dimensions given are the largest external dimensions of the unit, including hanger attachments.
 All specifications are measured at standard external static pressure.

High Static Pressure Duct

- External static pressure up to 400Pa facilitates extensive duct and grille network
- 20-step static pressure control on all models (requires latest generation wired controllers)
- A double-skin drainage pan provides double protection for ceilings From 7.1kW to 16kW.
- Water pump box is available as an option installed independently.



Optional controller



WL-12B-CM WL-12F-CM WR-86KD-CM WR-120G-CM

Model		42VD024H115011016		42VD028H115011016		42VD030H115011016		
Power supply		1 phase, 220-240V, 50/60Hz						
Cooling ¹	Capacity	kW	7.1	8.0	9.0			
		kBtu/h	24.2	27.3	30.7			
Power input		W	180	180	220			
Heating ²	Capacity	kW	8.0	9.0	10.0			
		kBtu/h	27.3	30.7	34.1			
Power input		W	180	180	220			
Air flow rate ³	m ³ /h	1360/1327/1293/1260/1227/1193/1160		1360/1327/1293/1260/1227/1193/1160		1420/1373/1327/1280/1233/1187/1140		
External static pressure	Pa	100 (30~200)						
Sound pressure level ⁴	dB(A)	42/41/40/40/39/39/38		42/41/40/40/39/39/38		45/44/43/42/41/40/39		
Unit	Net dimensions ⁵ (WxHxD)	mm	965x423x690				1090x440x768	
	Packed dimensions (WxHxD)	mm	41/47					
	Net/Gross weight	kg						
	Liquid/Gas pipe	mm	Φ9.53/Φ15.9					
Pipe connections	Drain pipe	mm	OD Φ25					

Model		42VD036H115011016		42VD048H115011016		42VD054H115011016		42VD070H115011016	
Power supply		1 phase, 220-240V, 50/60Hz							
Cooling ¹	Capacity	kW	11.2	14.0	16.0	20.0			
		kBtu/h	38.2	47.8	54.6	68.2			
Power input		W	380	420	700	990			
Heating ²	Capacity	kW	12.5	16.0	17.0	22.5			
		kBtu/h	42.7	54.6	58.0	76.8			
Power input		W	380	420	700	990			
Air flow rate ³	m ³ /h	1870/1783/1697/1610/1523/1437/1350		2240/2133/2027/1920/1813/1707/1600		2660/2530/2400/2270/2140/2010/1880		4330/4230/4130/4030/3930/3830/3730	
External static pressure	Pa	100 (30~200)							
Sound pressure level ⁴	dB(A)	48/47/46/45/43/42/41		45/44/43/42/41/40/40		46/45/44/43/42/41/40		51/50/50/49/49/48/47	
Unit	Net dimensions ⁵ (WxHxD)	mm	965x423x690		1322x423x691		1454x515x931		
	Packed dimensions (WxHxD)	mm	1090x440x768		1436x450x768		1509x550x990		
	Net/Gross weight	kg	48/55		68/76		130/142		
	Liquid/Gas pipe	mm	Φ9.53/Φ19.1				Φ12.7/Φ22.2		
Pipe connections	Drain pipe	mm	OD Φ25				OD Φ32		

Model		42VD085H115011016		42VD096H115011016		42VD140H115011016		42VD160H115011016		42VD190H115011016	
Power supply		1 phase, 220-240V, 50/60Hz									
Cooling ¹	Capacity	kW	25.0	28.0	40.0	45.0	56				
		kBtu/h	85.3	95.5	136.5	153.6	191.1				
Power input		W	1200	1200	1800	1800	2272				
Heating ²	Capacity	kW	26.0	31.5	45.0	56.0	63				
		kBtu/h	88.7	107.5	153.6	191.1	215				
Power input		W	1200	1200	1800	1800	2272				
Air flow rate ³	m ³ /h	4330/4230/4130/4030/3930/3830/3730				6500/6150/5800/5450/5100/4750/4400		7400/7000/6600/6200/5800/5400/5000			
External static pressure	Pa	170 (30~250)									
Sound pressure level ⁴	dB(A)	51/50/50/49/49/48/47				60/59/58/57/55/54/52		59/58/57/56/55/53/51			
Unit	Net dimensions ⁵ (WxHxD)	mm	1440x505x925		2010x680x905		2095x800x964		2095x800x964		
	Packed dimensions (WxHxD)	mm	1509x550x990		220/245		218/248				
	Net/Gross weight	kg	130/142		Φ15.9/Φ28.6		Φ15.9/Φ28.6				
	Liquid/Gas pipe	mm	Φ12.7/Φ22.2		OD Φ32		OD Φ32				
Pipe connections	Drain pipe	mm	OD Φ32				OD Φ32				

Notes:
 1. Indoor temperature 27°C DB, 19°C WB; outdoor temperature 35°C DB; equivalent refrigerant piping length 7.5m with zero level difference.
 2. Indoor temperature 20°C DB; outdoor temperature 7°C DB, 6°C WB; equivalent refrigerant piping length 7.5m with zero level difference.
 3. Each model's 7 airflow rate options are listed in order, from highest to lowest.
 4. Each model's 7 sound pressure levels are listed in order from highest to lowest and correspond to the model's 7 airflow rate options (see Note 3). Sound pressure level is measured 1.4m below the unit in a semi-anechoic chamber.
 5. Unit body dimensions given are the largest external dimensions of the unit, including hanger attachments.
 All specifications are measured at standard external static pressure.

Fresh Air Processing Unit



Optional controller



- 100% fresh air processing unit, both fresh air filtration and heating/cooling can be achieved in a single system
- External static pressure up to 400Pa facilitates extensive duct and grille network
- 20-step static pressure control on all models (requires latest generation wired controllers)
- Water pump box is available as an option installed independently.

Model	42VD042H115211016		42VD048H115211016	
Power supply	1 phase, 220-240V, 50/60Hz			
Cooling ¹	Capacity	kW	12.5	14.0
		kBtu/h	42.6	47.8
Power input		W	480	480
	Capacity	kW	10.5	12.0
Heating ²		kBtu/h	36.0	41.0
	Power input	W	480	480
Air flow rate ³	m ³ /h 2000/1917/1833/1750/1667/1583/1500			
External static pressure	Pa 150(100-250)			
Sound pressure level ⁴	dB(A) 48/47/46/45/44/43/42			
Unit	Net dimensions ⁵ (WxHxD)	mm	1322x423x691	
	Packed dimensions (WxHxD)	mm	1436x450x768	
	Net/Gross weight	kg	68/76	
Pipe connections	Liquid/Gas pipe	mm	Ø9.53/Ø19.1	
	Drain pipe	mm	OD Ø25	
Operating temperature range	°C Heating: -5 to 16; Cooling: 20 to 43; Fan only: 16 to 20			

Model	42VD070H115211016	42VD085H115211016	42VD096H115211016	42VD160H115211016	42VD190H115211016		
Power supply	1 phase, 220-240V, 50/60Hz						
Cooling ¹	Capacity	kW	20.0	25.0	28.0	45.0	56
		kBtu/h	68.2	85.3	95.5	153.6	191
Power input		W	850	850	850	1080	2272
	Capacity	kW	12.8	16.0	18.0	28.0	39
Heating ²		kBtu/h	43.7	54.6	61.4	95.6	133
	Power input	W	850	850	850	1080	2272
Air flow rate ³	m ³ /h 3000/2833/2667/2500/2333/2167/2000		4200/3967/3733/3500/3267/3033/2800		6000/5665/5330/5000/4665/4330/4000		
External static pressure	Pa 200(100-400)		300(100-400)		300(100-400)		
Sound pressure level ⁴	dB(A) 50/49/48/47/46/44/43		58/56/55/53/51/49/48		59/57/56/55/53/51/50		
Unit	Net dimensions ⁵ (WxHxD)	mm	1454x515x931		2010x905x680		
	Packed dimensions (WxHxD)	mm	1509x550x990		2095x929x689		
	Net/Gross weight	kg	130/142		195/215 218/248		
Pipe connections	Liquid/Gas pipe	mm	Ø12.7/Ø22.2		Ø15.9/Ø28.6		
	Drain pipe	mm	OD Ø32		OD Ø32		
Operating temperature range	°C Heating: -5 to 16; Cooling: 20 to 43; Fan only: 16 to 20						

Model	42VD048H115211016-S		42VD070H115211016-S		42VD096H115211016-S	
Power supply	1-phase, 220-240V, 50/60Hz					
Cooling ¹	Capacity	kW	14.0	22.4	28.0	28.0
		kBtu/h	47.8	76.4	95.5	95.5
Power input		W	150	250	300	300
	Capacity	kW	8.9	13.9	17.4	17.4
Heating ²		kBtu/h	30.4	47.4	59.4	59.4
	Power input	W	150	250	300	300
Airflow rate ³	m ³ /h 1080/1035/990/945/900/855/810 1680/1583/1487/1390/1293/1197/1100 2100/2030/1960/1890/1820/1750/1680					
External static pressure ⁴	Pa 180 (30-250) 220 (100-350) 200 (100-400)					
Sound pressure level ⁵	dB(A) 42/41/40/39/38/37/36 47/46/45/44/43/42/40 47/46/45/45/44/43/42					
Indoor unit	Net dimensions (WxHxD)	mm	1150x457x970		1270x490x1100	
	Packed dimensions (WxHxD)	mm	1285x470x1095		1415x515x1235	
	Net/Gross weight	kg	67/80		81/97	
Pipe connections	Liquid/Gas pipe	mm	Ø9.5/Ø15.9		Ø12.7/Ø22.2	
	Drain pipe	mm	OD Ø25		OD Ø33	
Operating temperature range	°C Heating: -10 to 16; Cooling: 20 to 50; Fan only: 5 to 43					

Notes:

1. Indoor temperature 27°C DB, 19°C WB; outdoor temperature 35°C DB; equivalent refrigerant piping length 7.5m with zero level difference.
2. Indoor temperature 20°C DB; outdoor temperature 7°C DB, 6°C WB; equivalent refrigerant piping length 7.5m with zero level difference.
3. Each model's 7 airflow rate options are listed in order, from highest to lowest.
4. Each model's 7 sound pressure levels are listed in order from highest to lowest and correspond to the model's 7 airflow rate options (see Note 3). Sound pressure level is measured 1.4m below the unit in a semi-anechoic chamber.
5. Unit body dimensions given are the largest external dimensions of the unit, including hanger attachments. All specifications are measured at standard external static pressure.

Wall Mounted Unit

Refrigerant outlet direction can be left, right or rear as the installation situation requires



Model	42VH007H115000106		42VH009H115000106	
Power supply	1 phase, 220-240V, 50/60Hz			
Cooling ¹	Capacity	kW	2.2	2.8
		kBtu/h	7.5	9.6
Power input		W	28	28
	Capacity	kW	2.4	3.2
Heating ²		kBtu/h	8.2	10.9
	Power input	W	28	28
Air flow rate ³	m ³ /h 422/411/402/393/380/368/356		417/402/386/370/353/338/316	
Sound pressure level ⁴	dB(A) 31/30/30/30/29/29/29 31/30/30/30/29/29/29			
Unit	Net dimensions ⁵ (WxHxD)	mm	835x280x203	
	Packed dimensions (WxHxD)	mm	935x385x320	
	Net/Gross weight	kg	8.4/12.1 9.5/13.1	
Pipe connections	Liquid/Gas pipe	mm	Ø6.35/Ø12.7	
	Drain pipe	mm	OD Ø16	

Model	42VH012H115000106		42VH016H115000106		42VH020H115000106	
Power supply	1 phase, 220-240V, 50/60Hz					
Cooling ¹	Capacity	kW	3.6	4.5	5.6	5.6
		kBtu/h	12.3	15.4	19.1	19.1
Power input		W	30	40	45	45
	Capacity	kW	4.0	5.0	6.3	6.3
Heating ²		kBtu/h	13.6	17.1	21.5	21.5
	Power input	W	30	40	45	45
Air flow rate ³	m ³ /h 656/628/591/573/544/515/488		594/563/535/507/478/450/424		747/713/685/648/613/578/547	
Sound pressure level ⁴	dB(A) 33/32/32/31/31/30/30 35/34/33/33/32/31/31 38/37/36/36/35/34/34					
Unit	Net dimensions ⁵ (WxHxD)	mm	990x315x223		1085x420x335	
	Packed dimensions (WxHxD)	mm	11.4/15.5		12.8/16.9	
	Net/Gross weight	kg	11.4/15.5		12.8/16.9	
Pipe connections	Liquid/Gas pipe	mm	Ø6.35/Ø12.7		Ø9.53/Ø15.9	
	Drain pipe	mm	OD Ø16			

Model	42VH024H115000106		42VH028H115000106		42VH030H115000106	
Power supply	1 phase, 220-240V, 50/60Hz					
Cooling ¹	Capacity	kW	7.1	8.0	9.0	9.0
		kBtu/h	24.2	27.3	30.7	30.7
Power input		W	55	55	82	82
	Capacity	kW	8.0	9.0	10.0	10.0
Heating ²		kBtu/h	27.3	30.7	34.1	34.1
	Power input	W	55	55	82	82
Air flow rate ³	m ³ /h 1195/1130/1065/1005/940/875/809 1195/1130/1065/1005/940/875/809 1421/1300/1125/1067/1005/934/867					
Sound pressure level ⁴	dB(A) 44/43/42/39/38/37/36 44/43/42/39/38/37/36 48/46/45/43/41/40/38					
Unit	Net dimensions ⁵ (WxHxD)	mm	1194x343x262		1290x375x460	
	Packed dimensions (WxHxD)	mm	17.0/22.4		17.0/22.4	
	Net/Gross weight	kg	17.0/22.4		17.0/22.4	
Pipe connections	Liquid/Gas pipe	mm	Ø9.53/Ø15.9		Ø9.53/Ø15.9	
	Drain pipe	mm	OD Ø16			

Notes:

1. Indoor temperature 27°C DB, 19°C WB; outdoor temperature 35°C DB; equivalent refrigerant piping length 7.5m with zero level difference.
2. Indoor temperature 20°C DB; outdoor temperature 7°C DB, 6°C WB; equivalent refrigerant piping length 7.5m with zero level difference.
3. Each model's 7 airflow rate options are listed in order, from highest to lowest.
4. Each model's 7 sound pressure levels are listed in order from highest to lowest and correspond to the model's 7 airflow rate options (see Note 3). Sound pressure level is measured 1m in front and 1m below the unit in a semi-anechoic chamber.
5. Unit body dimensions given are the largest external dimensions of the unit, including hanger attachments.

Ceiling / Floor

Can be installed either on the ceiling or floor



Model	42VF012H115000016	42VF016H115000016	42VF020H115000016	42VF024H115000016		
Power supply	1 phase, 220-240V, 50/60Hz					
Cooling ¹	Capacity	kW	3.6	4.5	5.6	7.1
		kBtu/h	12.3	15.4	19.1	24.2
	Power input	W	49	115	115	115
Heating ²	Capacity	kW	4.0	5.0	6.3	8.0
		kBtu/h	13.6	17.1	21.5	27.3
	Power input	W	49	115	115	115
Air flow rate ³	m ³ /h	550/525/500/480/460/440/420		800/750/700/650/600/550/500		
Sound pressure level ⁴	dB(A)	40/39/38/38/37/36/36		43/42/41/41/39/38/38		
Unit	Net dimensions ⁵ (WxHxD)	mm	990x660x203			
	Packed dimensions (WxHxD)	mm	1089x744x296			
	Net/Gross weight	kg	27/33	28/34		
Pipe connections	Liquid/Gas pipe	mm	Φ6.35/Φ12.7		Φ9.53/Φ15.9	
	Drain pipe	mm	OD Φ16			

Model	42VF028H115000016	42VF030H115000016	42VF036H115000016	42VF048H115000016	42VF060H115000016		
Power supply	1 phase, 220-240V, 50/60Hz						
Cooling ¹	Capacity	kW	8.0	9.0	11.2	14.0	16.0
		kBtu/h	27.2	30.7	38.2	47.8	54.6
	Power input	W	130	130	180	180	288
Heating ²	Capacity	kW	9.0	10.0	12.5	15.0	18.0
		kBtu/h	30.7	34.1	42.7	51.2	61.4
	Power input	W	130	130	180	180	288
Air flow rate ³	m ³ /h	1280/1245/1210/1170/1130/1085/1050		1890/1830/1765/1700/1660/1620/1580		2300/2240/2180/2100/2005/1950/1800	
Sound pressure level ⁴	dB(A)	45/44/43/43/42/41/40		47/46/45/45/44/43/42		50/49/48/47/46/45/44	
Unit	Net dimensions ⁵ (WxHxD)	mm	1280x660x203		1670x680x244		
	Packed dimensions (WxHxD)	mm	1379x744x296		1915x760x330		
	Net/Gross weight	kg	35/41		48/58		
Pipe connections	Liquid/Gas pipe	mm	Φ9.53/Φ15.9				
	Drain pipe	mm	OD Φ16				

Notes:
 1. Indoor temperature 27°C DB, 19°C WB; outdoor temperature 35°C DB; equivalent refrigerant piping length 7.5m with zero level difference.
 2. Indoor temperature 20°C DB; outdoor temperature 7°C DB, 6°C WB; equivalent refrigerant piping length 7.5m with zero level difference.
 3. Each model's 7 airflow rate options are listed in order, from highest to lowest.
 4. Each model's 7 sound pressure levels are listed in order from highest to lowest and correspond to the model's 7 airflow rate options (see Note 3).
 Floor standing: Sound pressure level is measured 1m in front and 1m above the floor in a semi-anechoic chamber.
 Ceiling mounted: Sound pressure level is measured 1m in front and 1m below the unit in a semi-anechoic chamber.
 5. Unit body dimensions given are the largest external dimensions of the unit, including hanger attachments.

Floor Standing Unit (Concealed)

• Designed to be concealed in walls with only the suction and discharge grills visible



Model	42VS007H115003016	42VS009H115003016		
Power supply	1 phase, 220-240V, 50/60Hz			
Cooling ¹	Capacity	kW	2.2	2.8
		kBtu/h	7.5	9.6
	Power input	W	40	45
Heating ²	Capacity	kW	2.4	3.2
		kBtu/h	8.2	10.9
	Power input	W	40	45
Air flow rate ³	m ³ /h	530/504/478/456/439/418/400		569/540/515/485/462/443/421
Sound pressure level ⁴	dB(A)	36/35/34/33/31/30/29		36/35/34/33/31/30/29
Unit	Net dimensions ⁵ (WxHxD)	mm	840x545x212	
	Packed dimensions (WxHxD)	mm	925x639x305	
	Net/Gross weight	kg	21.4/25.6	
Pipe connections	Liquid/Gas pipe	mm	Φ6.35/Φ12.7	
	Drain pipe	mm	Φ16	

Model	42VS012H115003016	42VS016H115003016		
Power supply	1 phase, 220-240V, 50/60Hz			
Cooling ¹	Capacity	kW	3.6	4.5
		kBtu/h	12.3	15.4
	Power input	W	55	60
Heating ²	Capacity	kW	4.0	5.0
		kBtu/h	13.6	17.1
	Power input	W	55	60
Air flow rate ³	m ³ /h	624/591/557/522/473/420/375		660/625/583/542/501/475/440
Sound pressure level ⁴	dB(A)	37/36/35/34/32/31/30		37/36/35/34/32/31/30
Unit	Net dimensions ⁵ (WxHxD)	mm	1036x639x305	
	Packed dimensions (WxHxD)	mm	1125x639x305	
	Net/Gross weight	kg	26.1/30.6	
Pipe connections	Liquid/Gas pipe	mm	Φ6.35/Φ12.7	
	Drain pipe	mm	Φ16	

Model	42VS020H115003016	42VS024H115003016	42VS028H115003016		
Power supply	1 phase, 220-240V, 50/60Hz				
Cooling ¹	Capacity	kW	5.6	7.1	8.0
		kBtu/h	19.1	24.2	27.3
	Power input	W	88	110	130
Heating ²	Capacity	kW	6.3	8.0	9.0
		kBtu/h	21.5	27.3	30.7
	Power input	W	88	110	130
Air flow rate ³	m ³ /h	1150/1094/1028/970/925/886/830	1380/1290/1205/1100/1033/955/870	1380/1290/1205/1100/1033/955/870	
Sound pressure level ⁴	dB(A)	41/39/37/35/33/32/31	44/42/40/39/37/35/33	44/42/40/39/37/35/33	
Unit	Net dimensions ⁵ (WxHxD)	mm	1340x545x220		
	Packed dimensions (WxHxD)	mm	1425x639x305		
	Net/Gross weight	kg	31/39		
Pipe connections	Liquid/Gas pipe	mm	Φ9.53/Φ15.9		
	Drain pipe	mm	Φ16		

Notes:
 1. Indoor temperature 27°C DB, 19°C WB; outdoor temperature 35°C DB; equivalent refrigerant piping length 7.5m with zero level difference.
 2. Indoor temperature 20°C DB; outdoor temperature 7°C DB, 6°C WB; equivalent refrigerant piping length 7.5m with zero level difference.
 3. Each model's 7 airflow rate options are listed in order, from highest to lowest.
 4. Each model's 7 sound pressure levels are listed in order from highest to lowest and correspond to the model's 7 airflow rate options (see Note 3).
 Sound pressure level is measured 1m in front and 1m above the floor in a semi-anechoic chamber.
 5. Unit body dimensions given are the largest external dimensions of the unit, including hanger attachments.
 All specifications are measured at 10Pa external static pressure.

Floor Standing Unit (Exposed)

The front air intake and underside air intake offer a choice of air intake options



front air intake 42VS***H115002016



underside air intake 42VS***H115001016

Standard controller



WL-12B-CM

Optional controller



WL-12F-CM



WR-86KD-CM



WR-120G-CM

Model		42VS007H115002016		42VS009H115002016	
		42VS007H115001016		42VS009H115001016	
Power supply		1 phase, 220-240V, 50/60Hz			
Cooling ¹	Capacity	kW	2.2	2.8	
		kBtu/h	7.5	9.6	
Heating ²	Capacity	kW	2.4	3.2	
		kBtu/h	8.2	10.9	
Air flow rate ³		m ³ /h	530/504/478/456/439/418/400	569/540/515/485/462/443/421	
		dB(A)	36/35/34/33/31/30/29	36/35/34/33/31/30/29	
Unit	Net dimensions ⁵ (WxHxD)	mm (F4)	1000x596x225		
		mm (F5)	1000x677x220		
	Packed dimensions (WxHxD)	mm (F4)	1089x683x312		
		mm (F5)	1182x683x312		
	Net/Gross weight	kg (F4)	28.2/32.8		
	kg (F5)	28.2/35.8			
Pipe connections	Liquid/Gas pipe	mm	Φ6.35/Φ12.7		
	Drain pipe	mm	Φ16		

Model		42VS012H115002016		42VS016H115002016	
		42VS012H115001016		42VS016H115001016	
Power supply		1 phase, 220-240V, 50/60Hz			
Cooling ¹	Capacity	kW	3.6	4.5	
		kBtu/h	12.3	15.4	
Heating ²	Capacity	kW	4.0	5.0	
		kBtu/h	13.6	17.1	
Air flow rate ³		m ³ /h	624/591/557/522/473/420/375	660/625/583/542/501/475/440	
		dB(A)	37/36/35/34/32/31/30	37/36/35/34/32/31/30	
Unit	Net dimensions ⁵ (WxHxD)	mm (F4)	1200x596x225		
		mm (F5)	1200x677x220		
	Packed dimensions (WxHxD)	mm (F4)	1289x683x312		
		mm (F5)	1382x683x312		
	Net/Gross weight	kg (F4)	33.1/38.2		
	kg (F5)	33.5/41.8			
Pipe connections	Liquid/Gas pipe	mm	Φ6.35/Φ12.7		
	Drain pipe	mm	Φ16		

Model		42VS020H115002016		42VS024H115002016		42VS028H115002016	
		42VS020H115001016		42VS024H115001016		42VS028H115001016	
Power supply		1 phase, 220-240V, 50/60Hz					
Cooling ¹	Capacity	kW	5.6	7.1	8.0		
		kBtu/h	19.1	24.2	27.3		
Heating ²	Capacity	kW	6.3	8.0	9.0		
		kBtu/h	21.5	27.3	30.7		
Air flow rate ³		m ³ /h	1150/1094/1028/970/925/886/830	1380/1290/1205/1100/1033/955/870	1380/1290/1205/1100/1033/955/870		
		dB(A)	41/39/37/35/33/32/31	44/42/40/39/37/35/33	44/42/40/39/37/35/33		
Unit	Net dimensions ⁵ (WxHxD)	mm (F4)	1500x596x225				
		mm (F5)	1500x677x220				
	Packed dimensions (WxHxD)	mm (F4)	1589x683x312				
		mm (F5)	1682x683x312				
	Net/Gross weight	kg (F4)	38.4/44.6				
	kg (F5)	39/47.7					
Pipe connections	Liquid/Gas pipe	mm	Φ9.53/Φ15.9				
	Drain pipe	mm	Φ16				

Notes:

- Indoor temperature 27°C DB, 19°C WB; outdoor temperature 35°C DB; equivalent refrigerant piping length 7.5m with zero level difference.
- Indoor temperature 20°C DB; outdoor temperature 7°C DB, 6°C WB; equivalent refrigerant piping length 7.5m with zero level difference.
- Each model's 7 airflow rate options are listed in order, from highest to lowest.
- Each model's 7 sound pressure levels are listed in order from highest to lowest and correspond to the model's 7 airflow rate options (see Note 3). Sound pressure level is measured 1m in front and 1m above the floor in a semi-anechoic chamber.
- Unit body dimensions given are the largest external dimensions of the unit, including hanger attachments.

Console

- Combination of four air inlets and two air outlets ensures that cooling and heating are distributed in all directions.



Standard controller



WL-12B-CM

Optional controller



WL-12F-CM



WR-86KD-CM



WR-120G-CM

Model		42VC007H115000016		42VC009H115000016		42VC012H115000016		42VC016H115000016	
Power supply		1 phase, 220-240V, 50/60Hz							
Cooling ¹	Capacity	kW	2.2	2.8	3.6	4.5			
		kBtu/h	7.5	9.6	12.3	15.4			
Heating ²	Capacity	kW	2.6	3.2	4.0	5.0			
		kBtu/h	8.9	10.9	13.6	17.1			
Air flow rate ³		m ³ /h	430/401/374/345/302/268/229	510/482/456/430/355/286/229	510/482/456/430/355/286/229	660/614/561/512/478/436/400			
		dB(A)	38/36/34/32/28/27/26	39/37/35/33/31/29/27		42/41/40/39/37/36/36			
Unit	Net dimensions ⁵ (WxHxD)	mm	700x600x210						
	Packed dimensions (WxHxD)	mm	810x710x305						
	Net/Gross weight	kg	14/19	15/20					
Pipe connections	Liquid/Gas pipe	mm	Φ6.35/Φ12.7						
	Drain pipe	mm	OD Φ16						







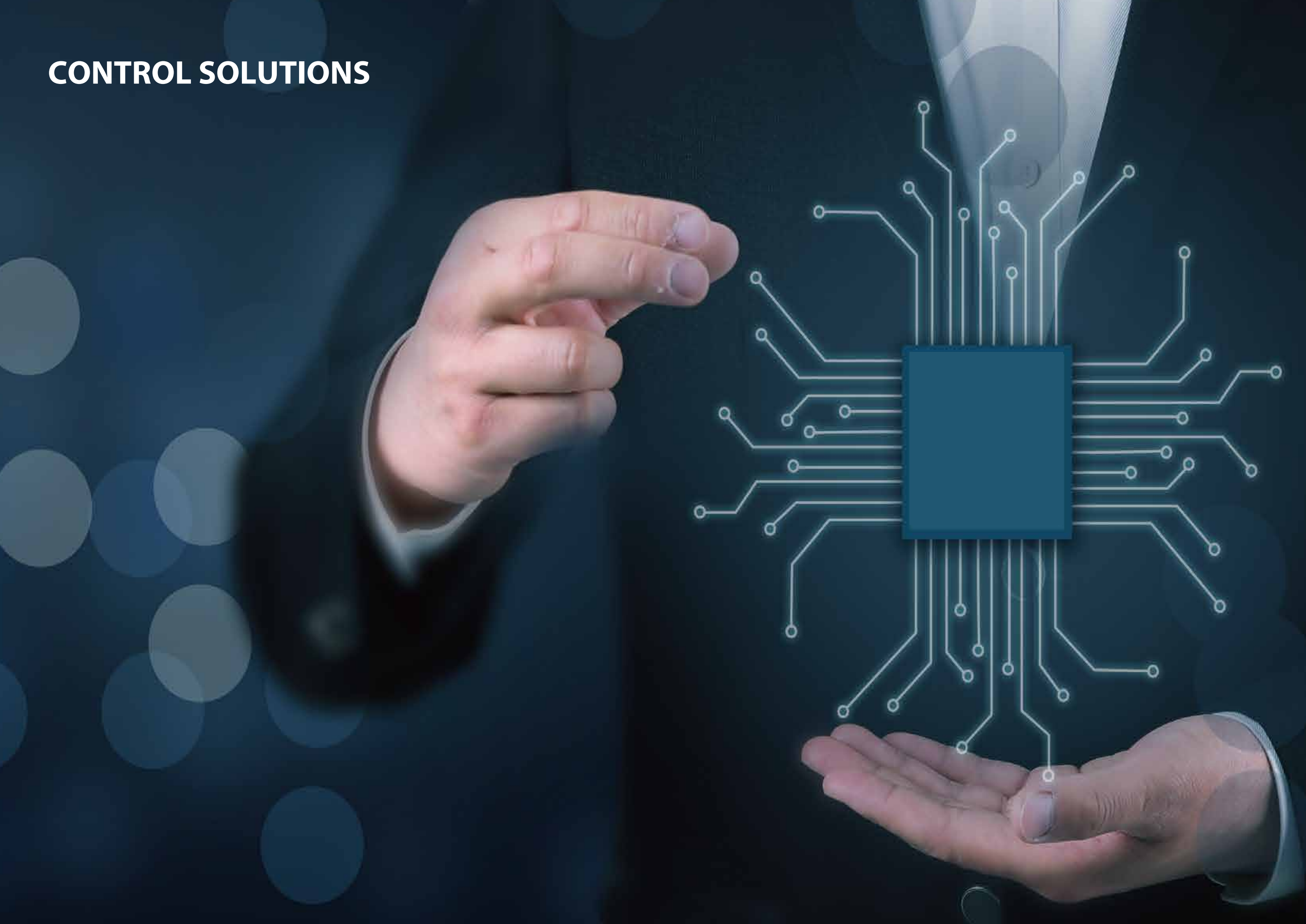











Notes:

- Indoor temperature 27°C DB, 19°C WB; outdoor temperature 35°C DB; equivalent refrigerant piping length 7.5m with zero level difference.
- Indoor temperature 20°C DB; outdoor temperature 7°C DB, 6°C WB; equivalent refrigerant piping length 7.5m with zero level difference.
- Each model's 7 airflow rate options are listed in order, from highest to lowest.
- Each model's 7 sound pressure levels are listed in order from highest to lowest and correspond to the model's 7 airflow rate options (see Note 3). Sound pressure level is measured 1m in front and 1m above the floor in a semi-anechoic chamber.
- Unit body dimensions given are the largest external dimensions of the unit, including hanger attachments.

CONTROL SOLUTIONS

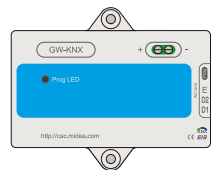

CONTROLLER LINEUP

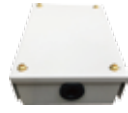
Wireless Remote Controllers	Wired Controllers	Centralized Controllers		Network Control System	BMS Gateways	Accessories
<p>WL-12B-CM</p>  <p>Standard wireless remote for all non-ducted indoor units</p>	<p>WR-86KD-CM</p>  <p>Factory recommended thermostat</p>	<p>CRF-180B-CM</p> 		<p>5GNS-BAC-CM</p>  <p>OR</p>	<p>5GNS-BAC-CM</p> 	<p>Hotel Key Card Interface Module</p>  <p>CA-HKCW</p>  <p>CA-HKCS</p>
<p>WL-12F-CM</p> 	<p>WR-120G-CM</p> 	<p>CRF-270C-CM</p> 		<p>CRF-270C-CM</p>  <p>+</p>	<p>NW-LON-CM-A</p> 	<p>Infrared Sensor Controller</p>   <p>CA-IS</p>
		<p>CRF-15B-CM</p> 		<p>4GNS-20-IF</p>  <p>=</p> <p>Intelligent Management System</p>	<p>NW-MOD-CM-A</p>   <p>NW-KNXA-CM</p>	<p>Diagnosis software</p>  <p>VRF-DIAG-B</p> <p>XYE Extension Kit</p>  <p>CA-EK</p> <p>Indoor Unit Online Kit</p>  <p>CAC-PIDU</p>

Wireless Remote Controllers



Features

Model	 WL-12B-CM	 WL-12F-CM
On / Off	●	●
Mode selection	●	●
Temperature setting	● (0.5°C or 1°C steps)	● (0.5°C or 1°C steps)
7-speed fan control	●	●
Auto swing	●	●
5-step swing louver	●	●
Address setting	●	●
Follow me	—	●
Eco mode	●	●
Night silent mode	●	●
Display shut-off	●	●
Daily timer	●	●
Keyboard lock	●	●
Background light	●	●
Dimensions (HxWxD) (mm)	150x65x20	170x48x20
Batteries		
louver independent control	—	●

● With this function

— Without this function

Temperature Setting

Set temperature can be adjusted in 0.5°C or 1°C steps, enabling precise comfort control.

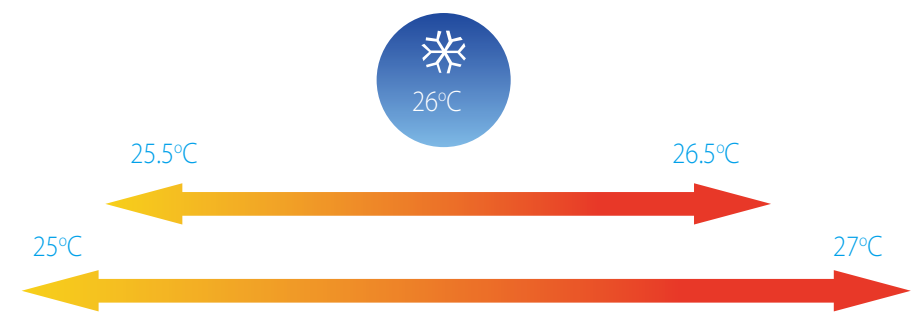

7-Speed Fan Control

7 indoor fan speeds provide control flexibility to meet the needs of different indoor conditions.

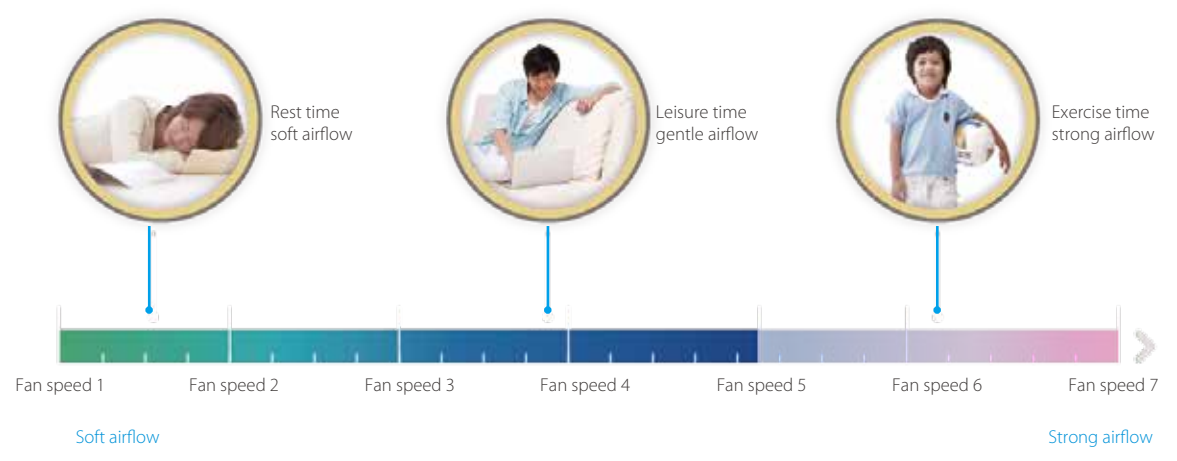

Display Shut-off

Indoor unit displays can be shut off at night, creating a better environment for rest.



5-step Swing Louver

The air is comfortably spread upwards and downwards thanks to the 5-step swing louver that can be programmed via the controller.

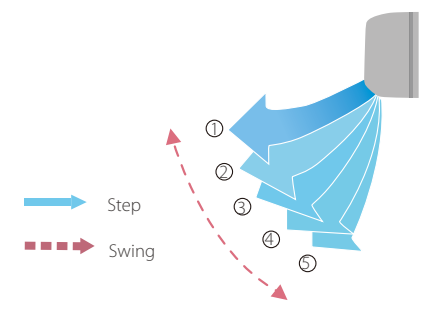

Follow Me

With the follow me function, the indoor unit responds to the temperature measured by the temperature sensor built-in to the wireless remote controller, rather than the temperature sensor in the indoor unit itself, enabling more precise control of the temperature in the user's immediate environment.



Eco Mode

Eco mode saves energy whilst retaining a comfortable indoor environment.



Wired Controllers



Features

Model	 WR-86KD-CM	 WR-120G-CM
On / Off	●	●
Mode selection	●	●
Temperature setting	● (0.5°C or 1°C steps)	● (0.5°C or 1°C steps)
Dual temperature set points	●	●
7-speed fan control	●	●
Auto swing	●	●
5-step swing louver	●	●
Address setting	●	●
Follow me	●	●
Eco mode	●	●
Room temperature display	●	●
°F/°C display	●	●
Keyboard lock	—	●
Background light	●	●
Daily timer	●	●
Weekly schedule timer	—	●
Auto restart	●	●
2 permission levels	—	●
Bi-directional communication	●	●
Group control	—	●
Main or secondary controller setting	●	●
Display shut-off	●	●
Night silent mode	●	●
Remote signal receiver	●	●
Clean filter reminder	●	●
Extension function	—	●
Daylight saving time	—	●
Clock display	—	●
Dot matrix display	—	●
Error check function	●	●
System parameter querying	●	●
System setting control	●	●
Dimensions (WxHxD) (mm)	86x86x18	120x120x20
Power supply	18 DC	18 DC

● With this function

— Without this function

Group Control

One controller can be used to unify the settings across up to 16 indoor units.



Main or Secondary Controller Setting

Two controllers can be used together, with the indoor units' operating mode and settings being set according to the most recent instruction received. The controller display screens are synchronized so that both displays update when a setting is adjusted.

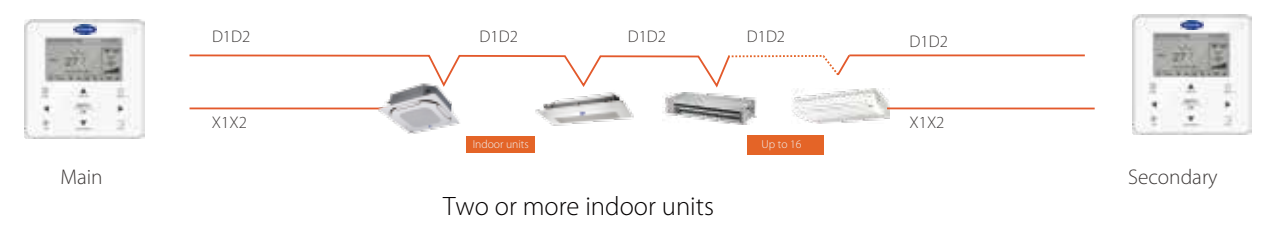

2 Permission Levels

2 permission levels ensure users can easily access control functions and allow administrators convenient access to operating parameters.

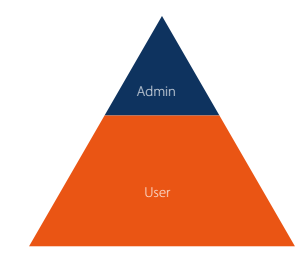

Extension Function

The extension function is specifically designed for users working overtime. Pressing the delay button postpones system shutdown by 1 or 2 hours.



Dual Temperature Set Points

With dual temperature set point control, the set temperature changes automatically when the operating mode is changed.

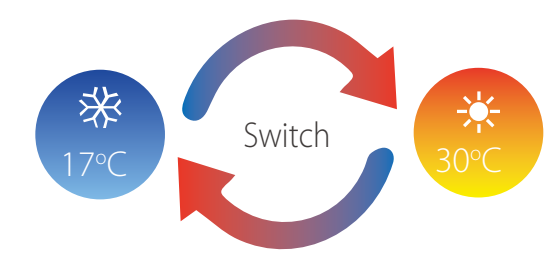

Weekly Schedule Timer

The weekly schedule timer allows users to set multiple schedules each with its own operating mode, temperature settings and fan speeds.

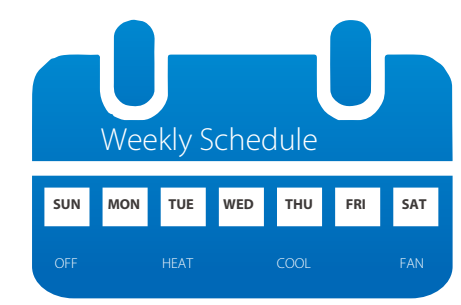

Bi-directional Communication

The wired controller can query the system operating parameters thanks to the new bi-directional communication functionality. In addition, settings including static pressure, cold draft prevention and temperature compensation can be configured on the wired controller.



Centralized Controllers



Features

Function	 CRF-180B-CM	 CRF-270C-CM
Max. number of indoor units	64	384
Max. number of refrigerant systems	8	48
Touch screen	● (6.2-inch)	● (10.1-inch)
On/Off	●	●
Mode selection	●	●
Temperature setting	● (0.5°C steps)*	
7-speed fan control		●*
Auto swing	●	●
5-step swing louver*	●	●
Room temperature display	●	●
Holiday setting	●	●
°C/°F display	●	●
Schedule management	●	●
Clock display	●	●
2 permission levels	●	●
Extension function	●	×
Indoor unit type/model recognition		●*
Indoor unit with capacity larger than 16kW recognition		●*
HRV Control	●	●
Visual schematic	×	●
Energy management	●	●
Group management	●	●
Error check function	●	●*
System parameter querying	●	●
USB output	●	●
Report display	Error report	Error report and operation record
Operation log	×	●
LAN access	×	●
Language supported	English, Chinese, French, Spanish, Portuguese, Italian, German, Polish, Turkish, Hungarian, Russian, Korean	
Dimensions (W×H×D) (mm)	182×123×34	270×183×27
Power supply	12V DC	24V AC
Outdoor unit series or indoor unit series	All series	

Note:

●: equipped as standard; ×: without this function

*means this function is only available for V6/V6i/V6R/V4+I(10-12HP), Mini C outdoor unit.

Touch Screen

Colorful touch screen and vivid display make operation more convenient and simple.



Electricity Charge Distribution

The controllers estimate the electricity consumption of the outdoor units and then divide it among the indoor units so that the electricity charges can be equitably divided among building occupants.



Energy Management

User can set limits or locks on an indoor unit, such as minimum cooling temperature, maximum heating temperature, fan speed, operation mode, swing lock, remote controller lock and wired controller lock.

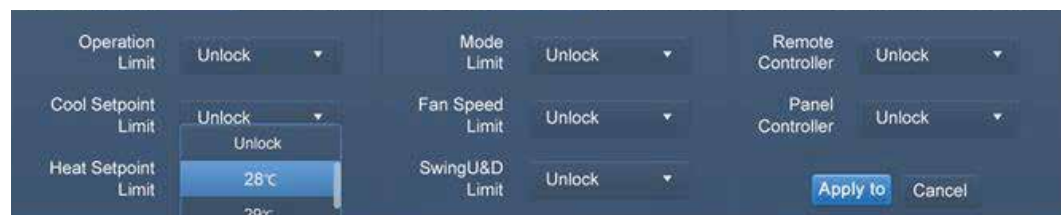

Visual Schematic

By importing floor plans and then dragging and dropping the indoor units to their actual positions on the floor plan, users can create a tailored system schematic which enables monitoring and control of the indoor units through a clear visual representation of the system layout.



Group Management

Units can be viewed according to group, system or location, making unit management clearer and more convenient.



Outdoor Unit Configuration

Outdoor unit configuration and settings can be monitored and controlled without having to go outdoors.



Unit Model Recognition

The controller recognizes the model of indoor and outdoor units and different models are represented by different icons.



Schedule Management

Daily, weekly or annual schedules can be used to set unit settings such as on/off, operating mode, set temperature, fan speed and swing.

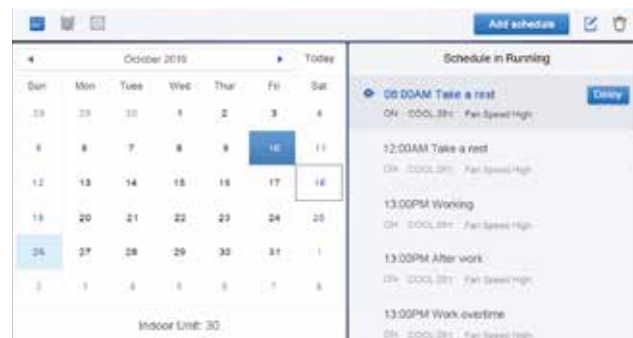

LAN Access

A desktop or laptop PC can be used for browser-based access via a LAN connection.



Wiring Flexibility

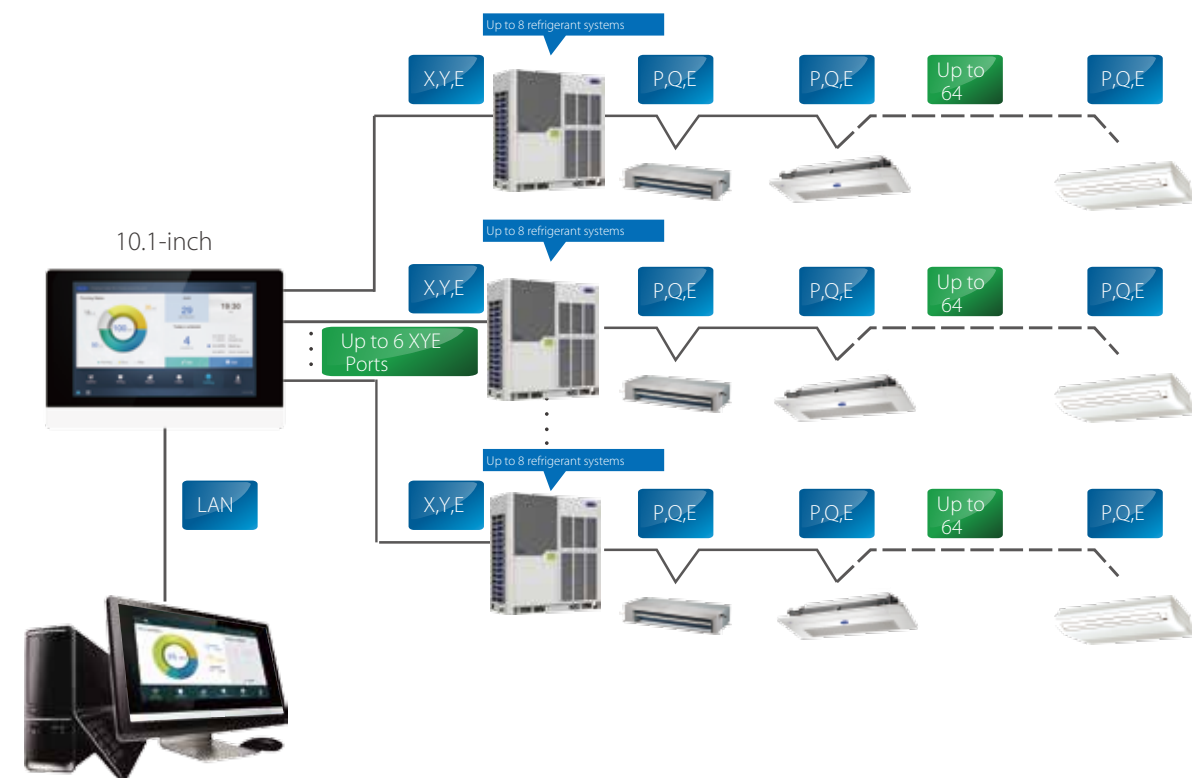
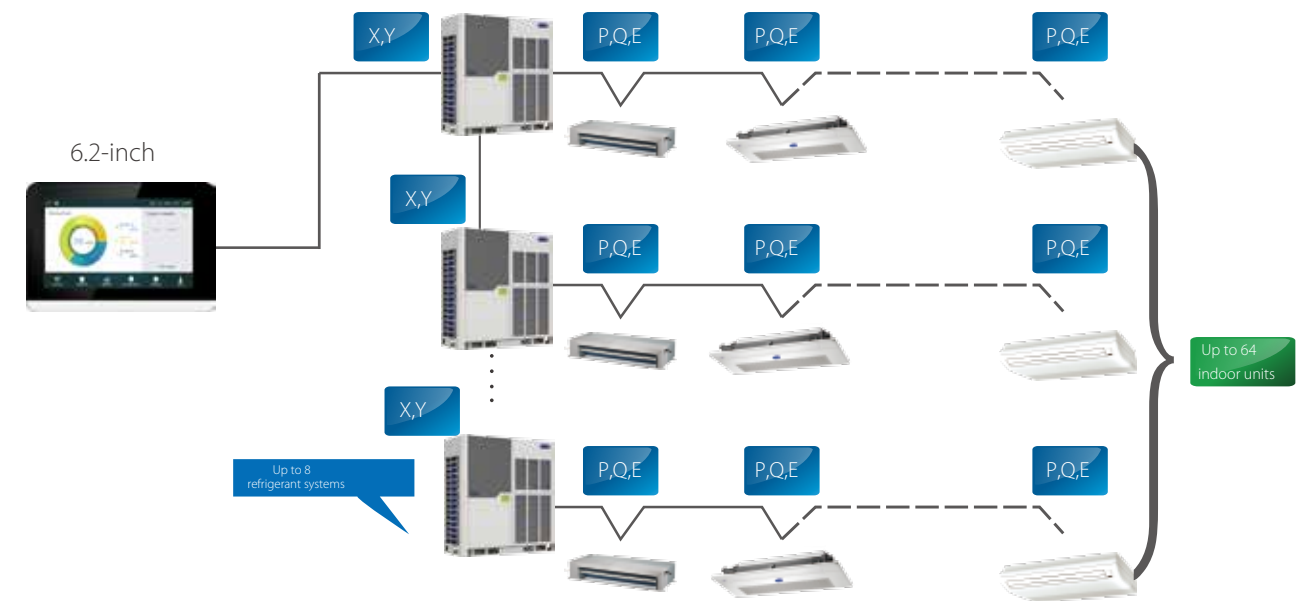

The controllers can be connected to the master outdoor unit directly.

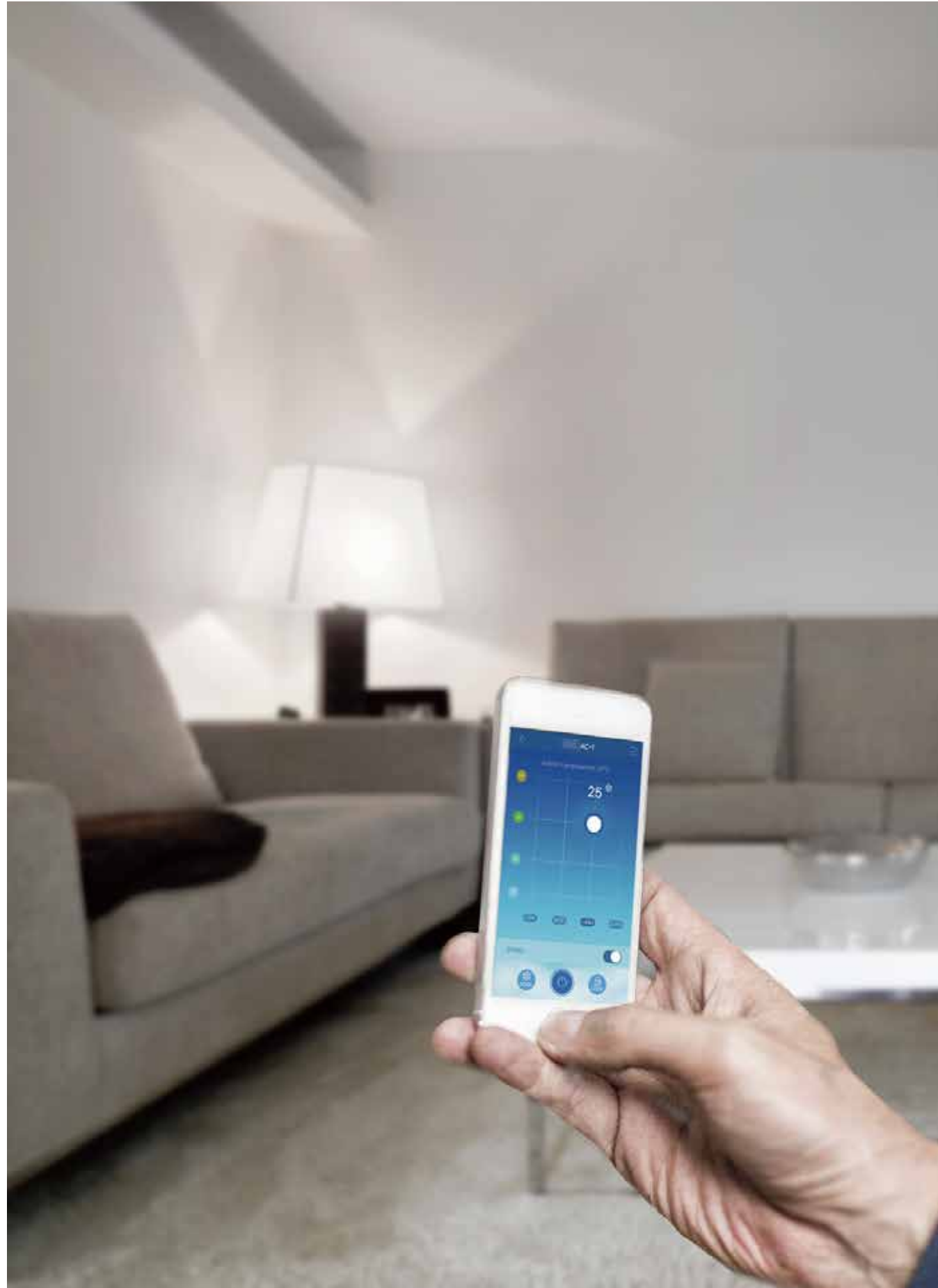

Data Converter



Features

Hardware model	 CIF-15B-CM	
Application scenarios	 Mobile Phone Application	 Cloud Server Website
Max. number of CCM-15 for one mobile APP	10	10
Max. number of indoor units	640	640
Max. number of refrigerant systems	80	80
On/Off	●	●
Mode selection	●	●
Temperature setting	● (1°C steps)	● (1°C steps)
7-speed fan control	—	—
Auto swing	●	●
5-step swing louver	—	—
Room temperature display	●	●
°C/°F display	●	●
Weekly timer	●	●
Indoor unit type recognition	—	—
Energy management	●	●
Group management	●	●
User group management	●	●
Operation log	●	●
Device log	●	●
Login record	●	●
Error log	—	●
Configuration	●	—
Account registration	●	—
Virtual	●	—
Mode display	●	●
Languages supported	English, French, Spanish	English, French, Spanish
Dimensions (WxHxD) (mm)	187x115x28	
Power supply	1 phase, 100-240V, 50/60Hz	

- With this function
- Without this function

High Compatibility

Compatible with a variety of operating systems.



User Friendly Interface

Clear, stylish interface designed by leading industrial designers.



Cloud Server Website

In addition to "M-control", users can control air conditioners and query the status of air conditioning equipment anytime and anywhere through the cloud server website.

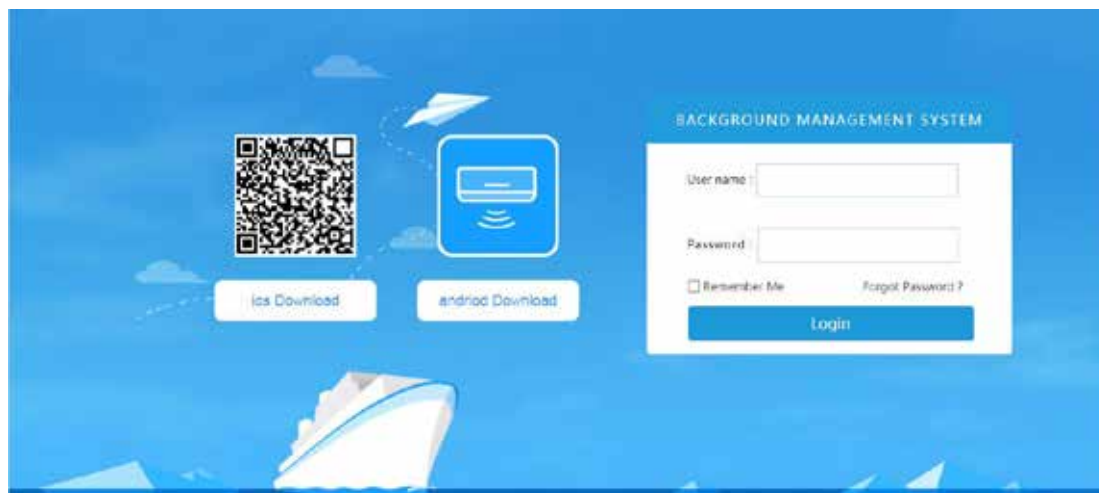

Virtual Experience

After downloading "M-control", you can experience the operation of the interface through the virtual experience function without registration.

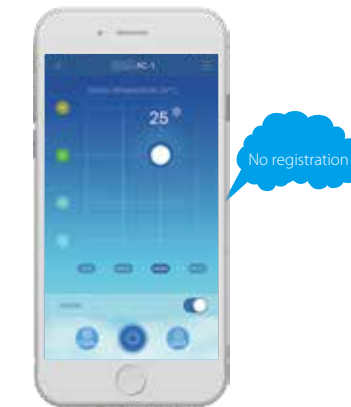

Easy Configuration

User groups can be joined simply by scanning a QR code.



Convenient Operation

Drag the position of the floating bubbles to change temperature and fan speed.



Anytime Control

Remote access to CIF-15A-CM allows anytime, anywhere control.



Clear Icons

Clear, color-coded icons allow unit operating states to be viewed at a glance.



Group Management

The user can group the air conditioners equipment, and the air conditioner in the same group can be controlled together just with one tap.



2 Permission Levels

Administrators can set different permissions for different users to facilitate better management of devices.

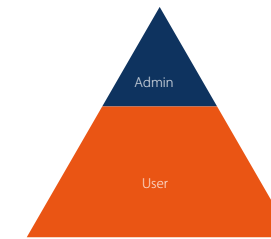

Multiple Language Options

Supports multiple languages so that users of different languages can operate easily.



Flexibility

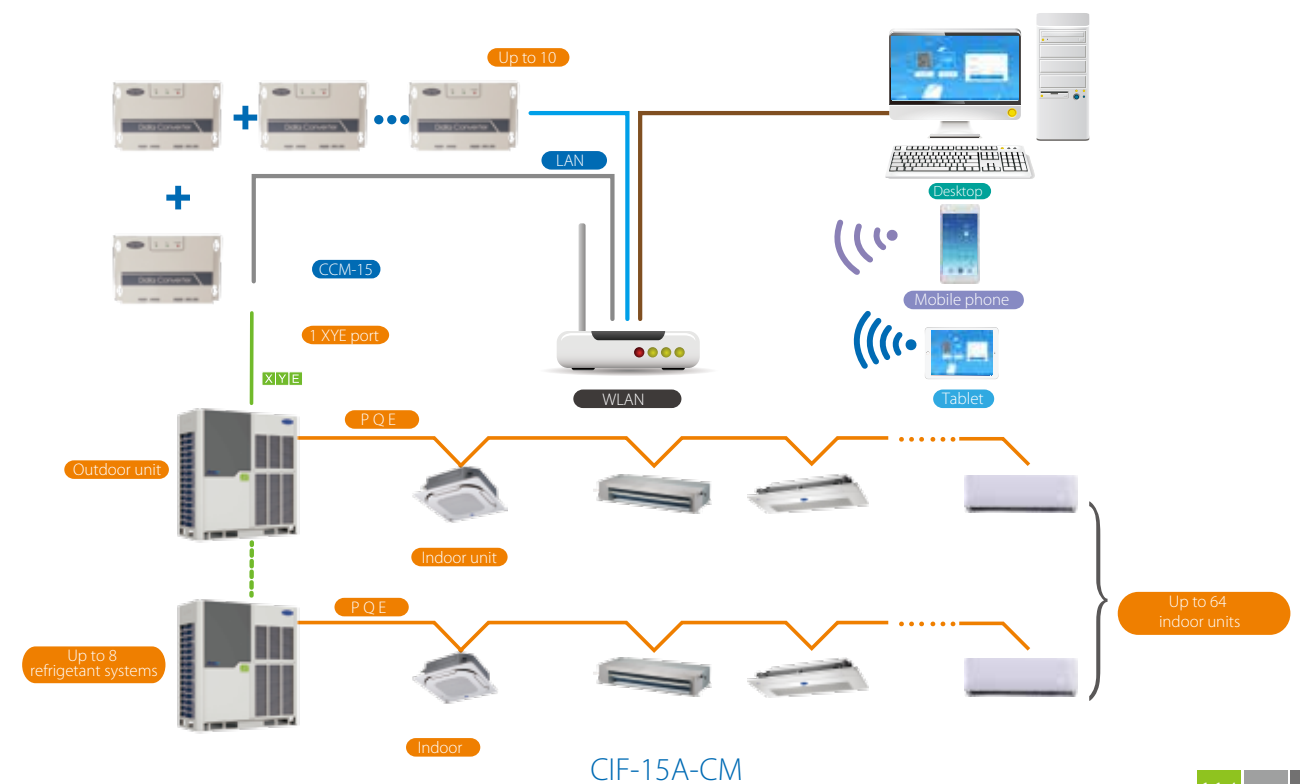

The Data Converter can be connected directly to a network of indoor/outdoor units.



Network Control System



Features

Software model	 IMMPRO	
Hardware model	 5GNS-BAC-CM	 CRF-270C-CM
Max. number per software system	10	10
Max. number of indoor units	2560	3840
Max. number of refrigerant systems	320	480
Temperature setting	● (0.5°C steps)	● (0.5°C steps)
7-speed fan control*	●	●
Auto swing	●	●
5-step swing louver	●	●
Outdoor unit Eco mode setting	●	●
Holiday setting	●	●
Schedule management	●	●
Clock display	●	●
2 permission levels	●	●
Unit model recognition	●	●
Electricity charge distribution	●	●
Visual schematic	●	●
Energy management	●	●
Group management	●	●
Error check function	●	●
System parameter querying	●	●
Report output	●	●
Operation log	●	●
LAN access	●	●
Languages supported	English, Chinese, French, Spanish, Portuguese, Italian, German, Polish, Turkish, Hungarian, Russian, Korean	
Dimensions (WxHxD) (mm)	251×319×61	270×183×27
Power supply	1 phase, 100-240V, 50/60Hz	24V AC

Note:

●: equipped as standard; ×: without this function

User-friendly Interface

Simple, practical user interface makes for a user-friendly experience even for first-time users.



Outdoor Unit Configuration

Outdoor unit configuration and settings can be monitored and controlled without having to go outdoors.

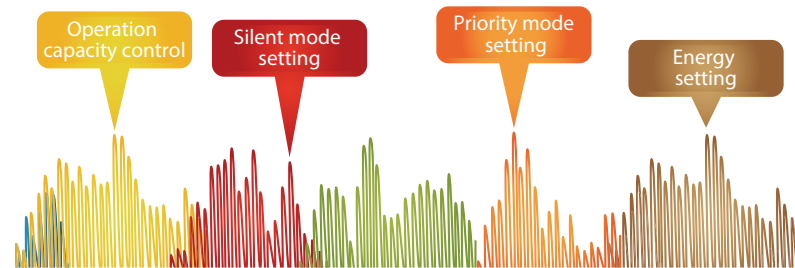

Electricity Charge Distribution

The IMMPRO uses the Calculation Method to estimate the electricity consumption of the outdoor units and then divide it among the indoor units so that the electricity charges can be equitably divided among building occupants.



Public and Idle Devices

Marking a unit as a public device or idle device ensures the electricity charge distribution is more accurate and reasonable.



Visual Schematic

By importing floor plans and then dragging and dropping the indoor units to their actual positions on the floor plan, users can create a tailored system schematic which enables monitoring and control of the indoor units through a clear visual representation of the system layout.



Schedule Management

Daily, weekly or annual schedules can be used to set unit settings such as on/off, operating mode, set temperature, fan speed and swing.



Xpress Installation

With the Xpress Installation wizard, IMMPRO can be installed quickly and easily without requiring support from a technical support engineer.

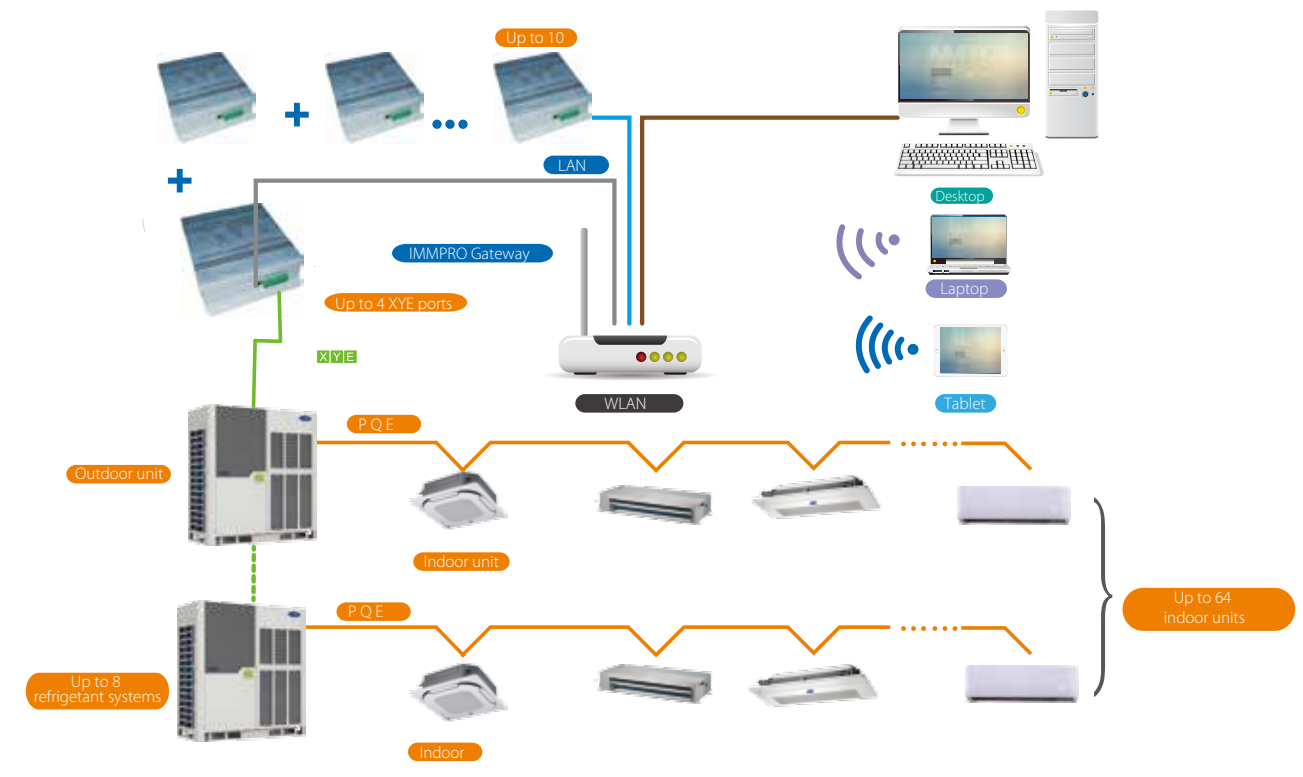

4GNS-BAC-CM

Network Flexibility

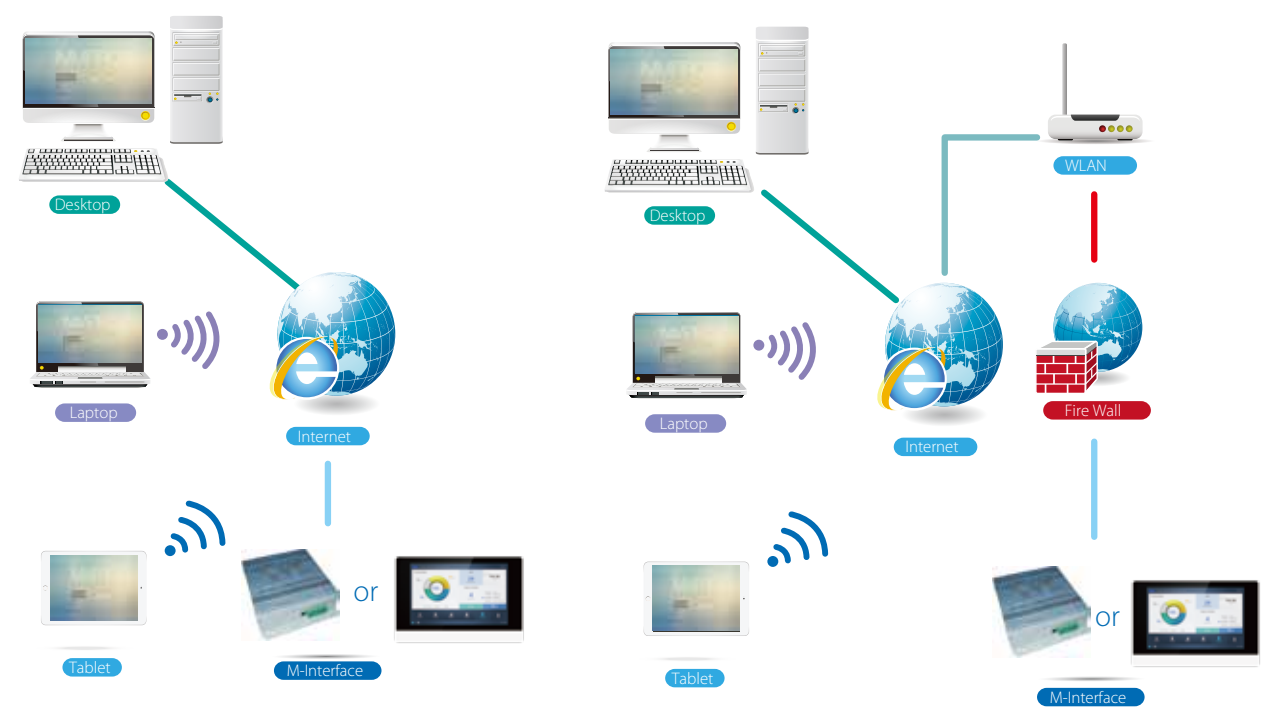

LAN access

Remote VPN access

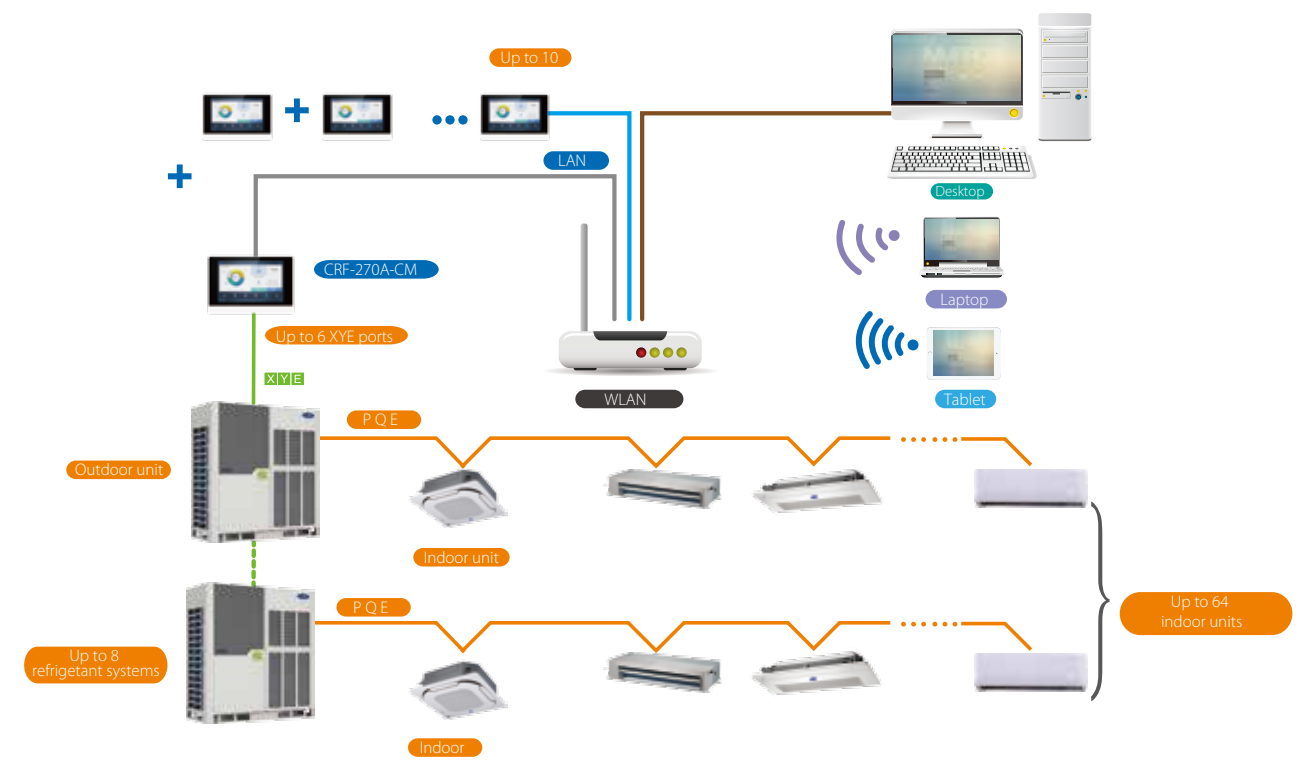

CRF-270B-CM

BMS Gateway

Monitoring and control of Carrier's VRF air conditioners can be integrated into building management systems, enabling air conditioning to be monitored alongside lighting, power, fire, access and security systems. Carrier's gateway devices provide full compatibility with the leading BMS protocols: BACnet, LonWorks and Modbus.



BACnet® Gateway



5GNS-BAC-CM

Full Integration

The 4GNS-BAC-CM Gateway allows Carrier VRF systems to be monitored and controlled alongside other building management technology that use the BACnet protocol such as access control, fire detection and lighting systems.

Network Flexibility

The gateway can be connected to master outdoor units' XYE ports directly.

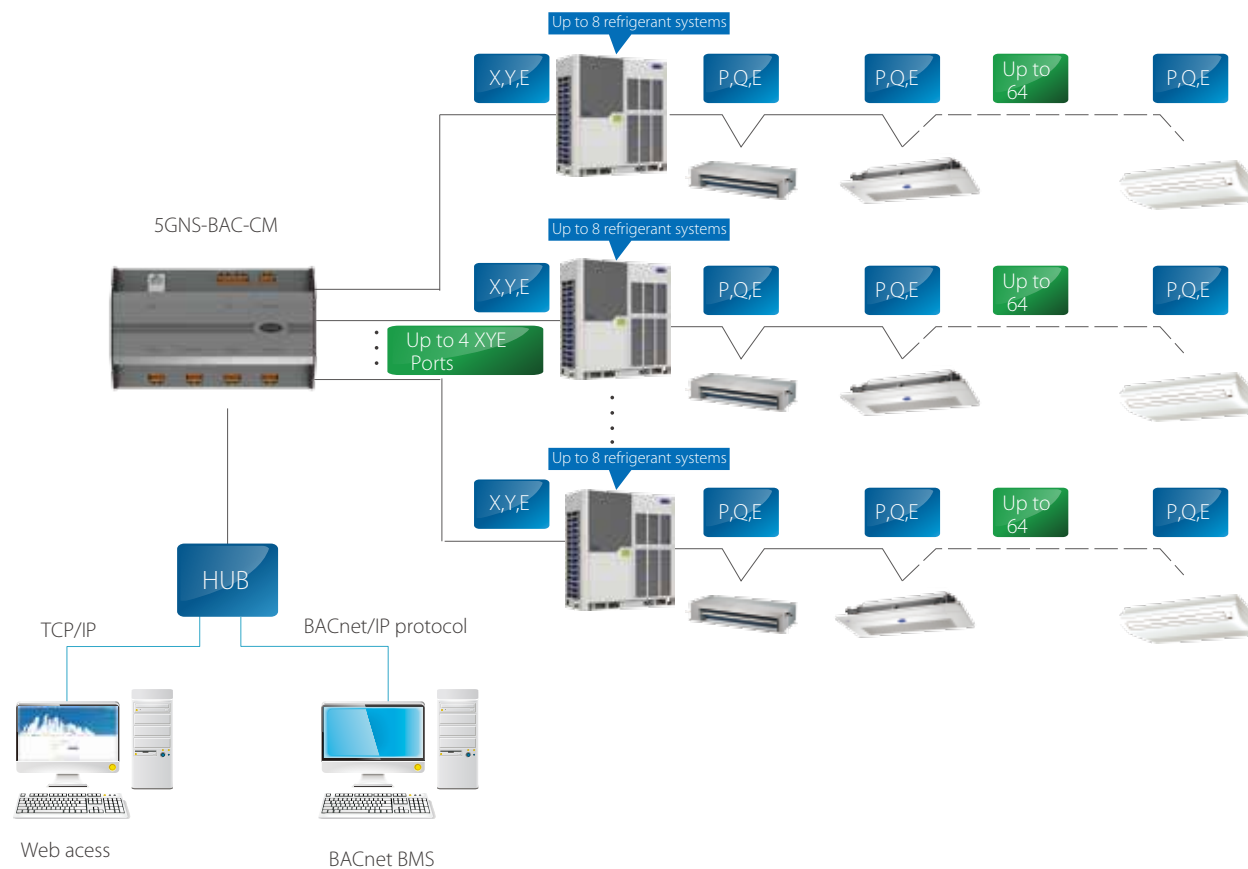

Features

Model	5GNS-BAC-CM		
Max. number of indoor units	256		
Max. number of outdoor units	128		
Max. number of refrigerant systems	32		
Control	On / Off	●	
	Mode selection	●	
	Temperature setting	●	
	Fan speed	●	
	Energy management	●	
Indoor unit monitoring	Room temperature display	●	
	Error status	●	
	Error alarms	●	
Outdoor unit monitoring	Operating mode	●	
	Outdoor ambient temperature	●	
	Fan speed	●	
	Compressor operating frequency	●	
	Discharge temperature	●	
	System pressure	●	
	Error status	●	
	Error alarms	●	
	LAN access	●	
	BTL certification	●	
Compatibility	Siemens	APOGEE	
	Trane	TRACER	
	Honeywell	ALERTON	
	Schneider	Andover Continuum	
	Johnson Controls	METASYS	
Dimensions (HxWxD) (mm)	116x190x67		
Power supply	24V AC 50/60Hz		

● With this function
 — Without this function



LonWorks® Gateway

NW-LON-CM-A

Full Integration

The NW-LON-CM Gateway allows Carrier VRF systems to be monitored and controlled alongside other building management technology on the LonWorks platform such as security, fire safety and lighting systems.

Network Flexibility

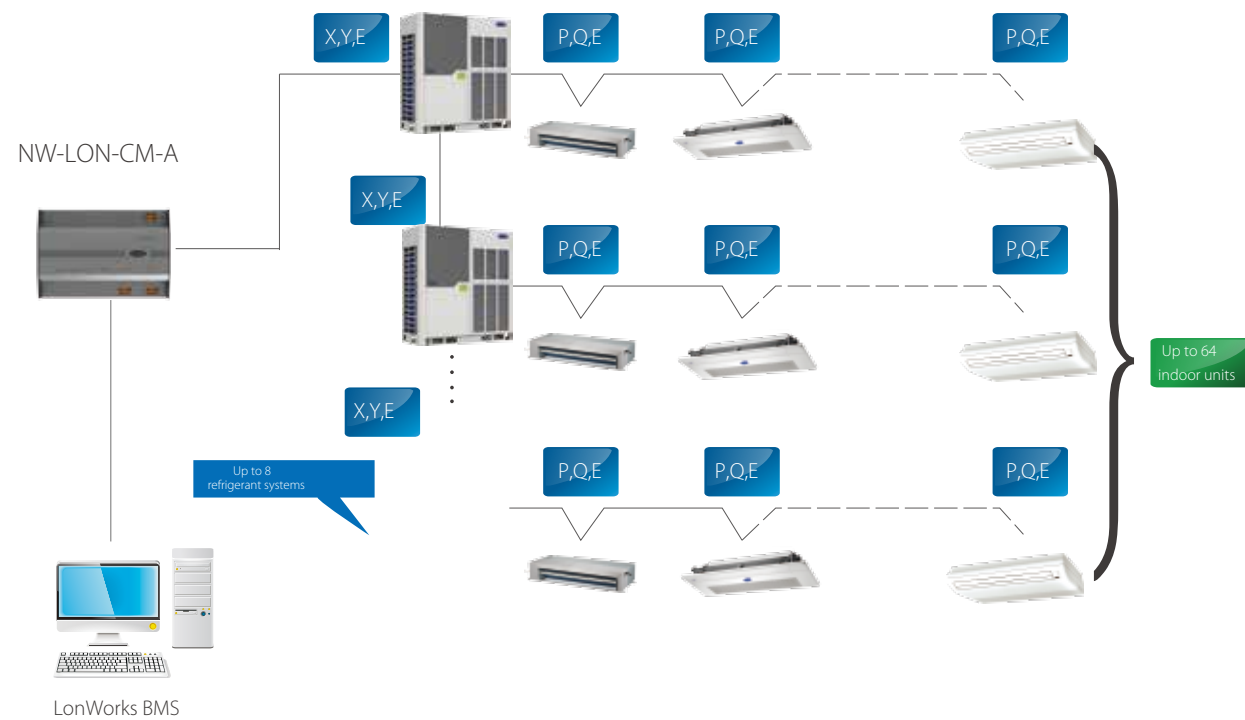

Features

Model	NW-LON-CM-A	
Max. number of indoor units		32
Max. number of refrigerant systems		8
Control	Mode selection	●
	Temperature setting	●
	Fan speed	●
	Group shut down	●
	On / Off	●
Indoor unit monitoring	Operating mode	●
	Set temperature	●
	Fan speed	●
	Online status	●
	Operating status	●
	Room temperature	●
	Error status	●
Outdoor unit monitoring	Error status	●
Dimensions (HxWxD) (mm)	116x170x67	
Power supply	24V AC 50/60Hz	

- With this function
- Without this function



NW-MOD-CM-A

Modbus® Gateway

Full Integration

The NW-MOD-CM Gateway enables seamless connection of Carrier VRF systems with building management systems built on the Modbus communication protocol.

Network Flexibility

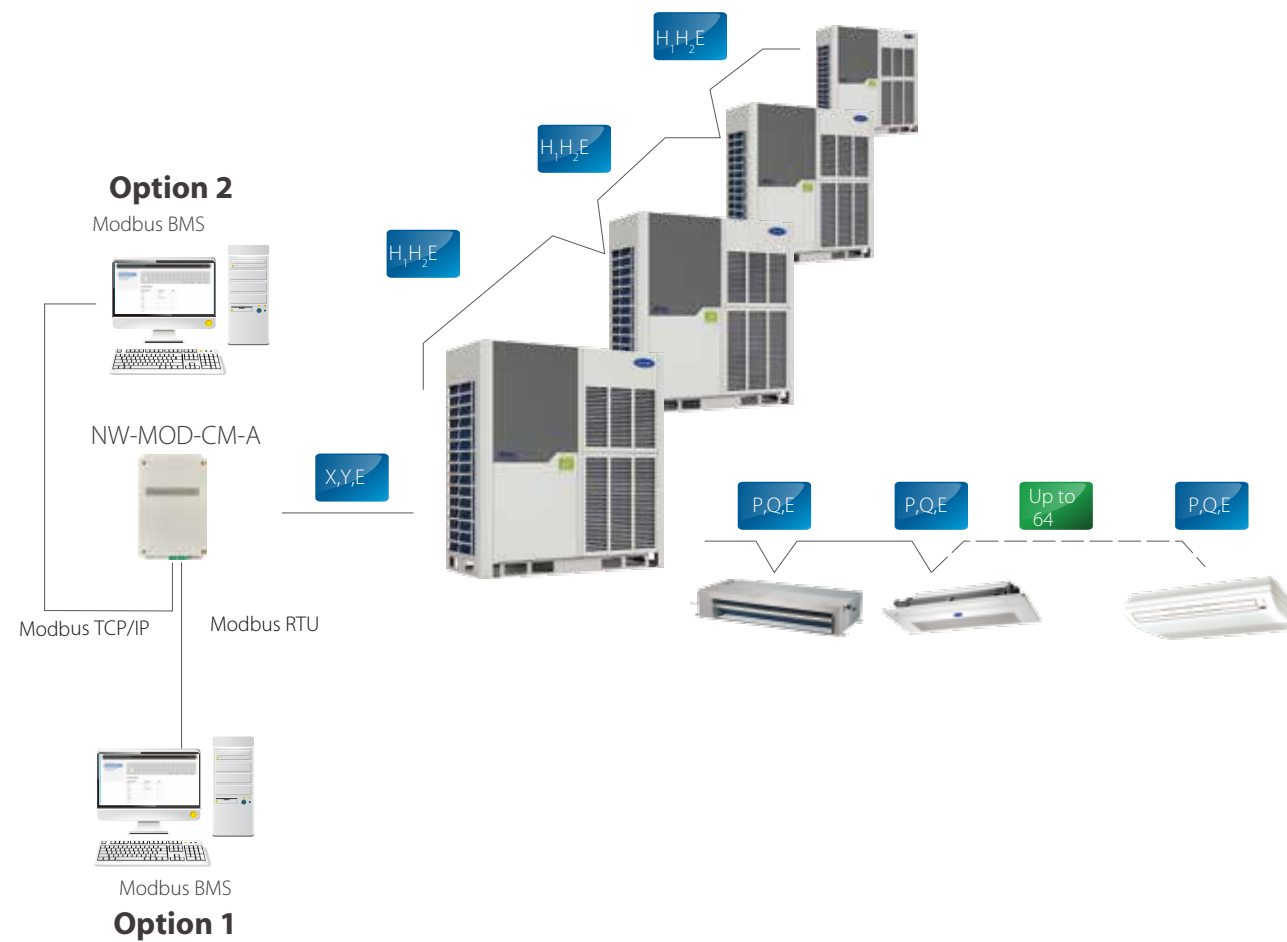

Features

Model	NW-MOD-CM	
Max. number of indoor units		64
Max. number of outdoor units		4
Max. number of refrigerant systems		1
Control	On / Off	●
	Mode selection	●
	Temperature setting	●
	Fan speed	●
	Group on/off	●
Indoor unit monitoring	Online status	●
	Room temperature	●
	Error status	●
	Operating mode	●
Outdoor unit monitoring	Operating mode	●
	Lock status	●
	Fan speed	●
	Set temperature	●
	Outdoor ambient temperature	●
	Error status	●
LAN access		●
Dimensions (HxWxD)(mm)		225x128x28
Power supply		12V DC

- With this function
- Without this function

KNX Gateway

Full Integration

The KNX Gateway enables full integration of Carrier VRF systems with home and building management systems built on the KNX network communications protocol. KNX is the only global standard for housing and building control, and has been adopted by 70% of Europe's smart home market.

Network Flexibility

The gateway can be connected to indoor units' XYE or D1D2E ports directly.

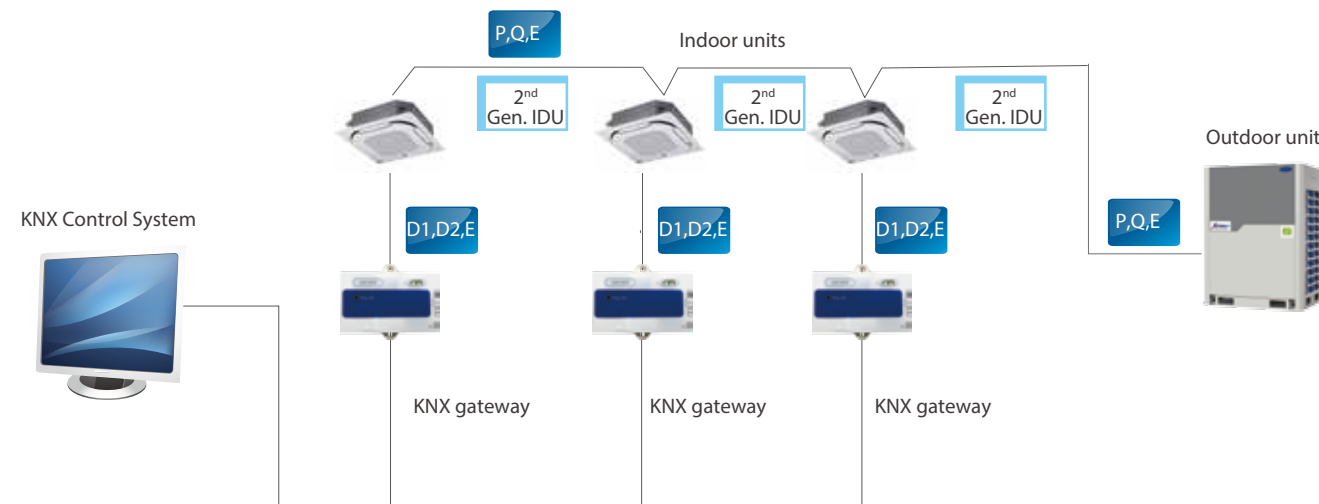

Features

Model		NW-KNXA-CM
Max. number of indoor units		1
Control	On / Off	●
	Mode selection	●
	Temperature setting	● (1°C steps)
	7-speed fan control	● (3-speed)
	Swing	●
Monitoring	On / Off	●
	Mode selection	●
	Temperature setting	●
	Fan speed	●
	Swing	●
	Room temperature	●
	Error alarm	●
Dimensions (HxWxD)(mm)		85x51x16
Power supply		29VDC (KNX bus supply)
Indoor unit series		2 nd generation DC IDU



Hotel Key Card Interface Modules



Full Integration

The Hotel Key Card Interface Modules enable power supply to indoor units to be integrated with hotel key card power supply management systems, which are designed to save energy by only running appliances whilst guests are present in their room.

Features

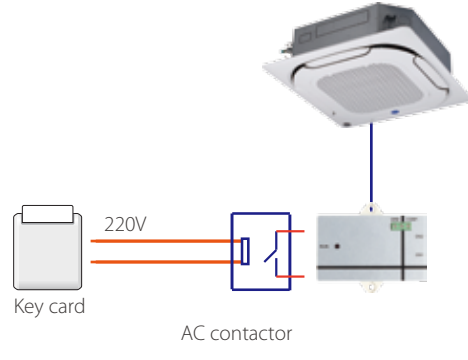
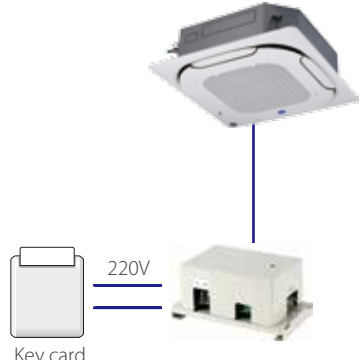
Model	CA-HKCW	CA-HKCS
Appearance		
Network flexibility		
Auto restart	●	●
Compatibility	Remote and wired controller	Remote and wired controller
Dimensions (HxWxD) (mm)	15.5x86x72.8	87x150x70
Power supply	5V DC (Supplied by indoor unit)	1 phase, 100-240V, 50/60Hz

Infrared Sensor Controller

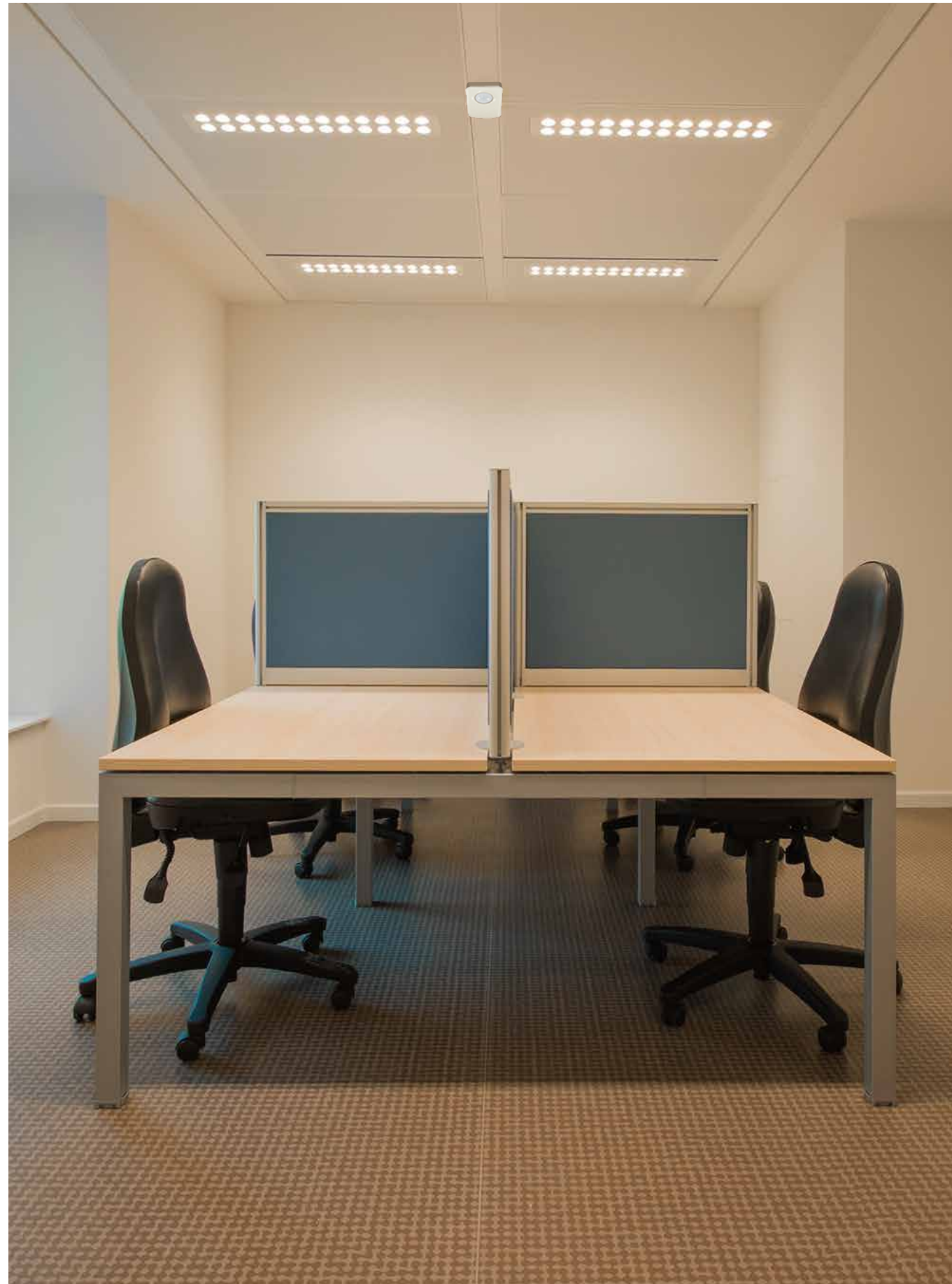

Full Integration

Using infrared sensors to detect movement, the CA-NIM09 Infrared Sensor Controller automatically turns indoor units on or off upon sensing that the room is occupied or unoccupied. Suitable for hotels, offices, conference rooms and residences, the Infrared Sensor Controller ensures climate control whilst minimizing energy consumption.

Features

Model	CA-IS
Appearance	
Network flexibility	
Dimensions (HxWxD)(mm)	Sensor 46x30x25.6, Control box 86x72.8x15.5
Power supply	5V DC (Supplied by indoor unit)

IDU Online Kit

If the power supply for one indoor unit fails, the indoor unit will still remain online and the whole VRF system will not stop. The IDU online kit will keep the indoor unit online, thus keeping the other indoor units of the system working normally and prevent unnecessary shutdown.

Features

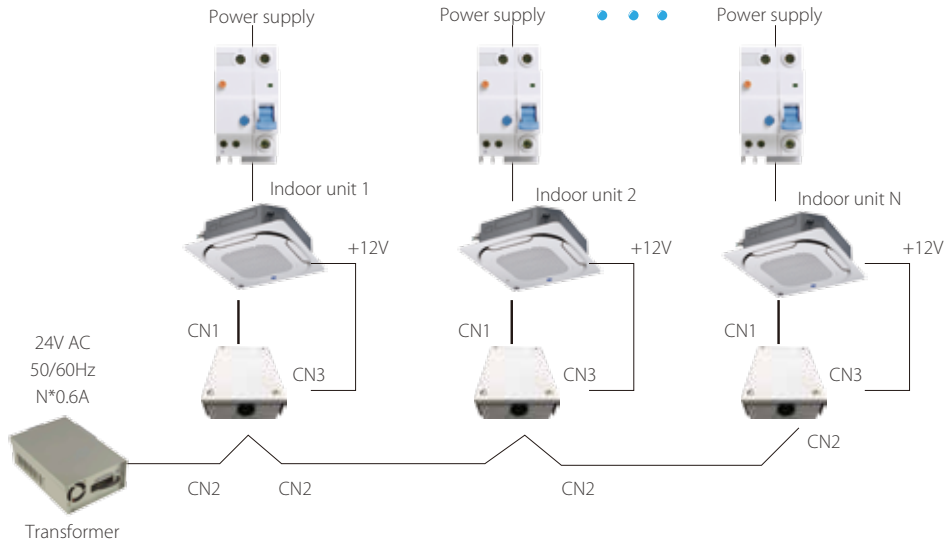
Model	 CAC-PIDU
Network flexibility	
Dimensions (HxWxD)(mm)	146.6 x 100.6x 46.8
Power supply	24V AC
Indoor unit series	All series

XYE Extension Kit

Simple Design

The CA-EK is used to extend the XYE port of outdoor unit as the 2-way one which can connect to 2 Central Controllers or gateways.

Features

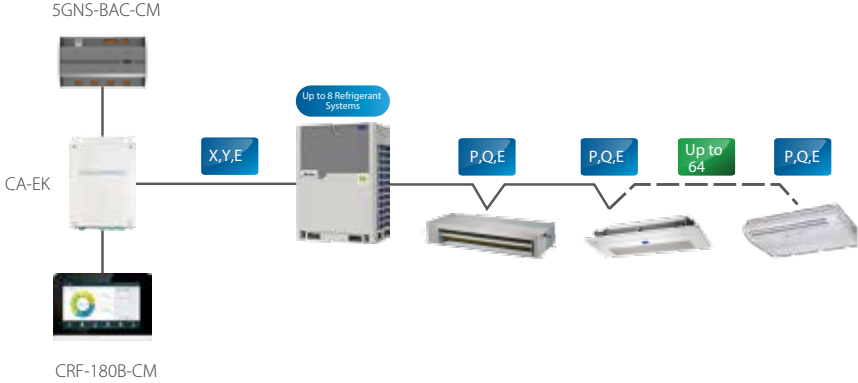
Model	 CA-EK
Max. number of refrigerant systems	8
Wiring flexibility	
Dimensions (HxWxD)(mm)	128X225X28
Power supply	12V DC
Outdoor unit series	all series*

Diagnosis Software

Monitor and Diagnose

Carrier's VRF Diagnosis Software tool is used to monitor VRF systems and diagnose system errors. System settings and operating parameters can be accessed easily and data logs can be reviewed for fault prevention purposes.

Features

Model	VRF-DIAG-B	
Max. number of indoor units		64
Max. number of outdoor units		4
Max. number of refrigerant systems		1
Control	Mode selection	●
	Temperature setting	●
	Fan speed	●
Outdoor unit monitoring	Operating mode	●
	Capacity	●
	Compressor operating frequency	●
	Operating current	●
	Error status	●
	Temperatures	T3,T4,Tp (See note 1)
	Valve statuses	SV2, SV4, SV5, SV6, ST1 (See note 2)
Indoor unit monitoring	Operating mode	●
	Capacity	●
	Fan speed	●
	Address	●
	Temperatures	T1, T2, T2B, TS (See note 3)
	EXV position	●
Error codes		●
Troubleshooting		●
Data logs		●
Diagrams	System schematic, refrigerant flow diagram, parameter chart	
Languges supported		English

● With this function
 — Without this function

Notes:

- Heat exchanger temperature, outdoor ambient temperature, discharge temperature.
- Discharge temperature control valve, oil return valve, defrosting valve, EXV bypass valve, four-way valve.
- Indoor ambient temperature, indoor heat exchanger mid-point temperature, indoor heat exchanger outlet temperature, set temperature.

Branch Header

Welding type (Applicable with Side discharge and top discharge VRF)

Dimension

Name	Gas side joints	Liquid side joints	Heat insulation material
header for 4 branches (DXFQT4-01)			
header for 8 branches (DXFQT8-01)			

Specification

Model	DXFQT4-01	DXFQT8-01
Max. total capacity of downstream indoor units	28kW	68kW
Max. number of downstream indoor units	4	8
Max. capacity of units per branch	16kW	16kW
Max. number of units per branch	1	1
Branch piping diameter (liquid pipe)	16mm	19mm
Branch piping diameter (gas pipe)	22mm	32mm
Max. connectable piping diameter (liquid pipe)	16mm	19mm
Max. connectable piping diameter (gas pipe)	25mm	32mm
Additional refrigerant charge	150g	250g
Diameter (indoor side)	Liquid pipe	ID6/ID9
	Gas pipe	ID12/ID16
Diameter (outdoor side)	Liquid pipe	ID9/ID12/ID16
	Gas pipe	ID19/ID22/ID25

Thread type (Applicable with MINI VRF only 8-16kW)

Name	Gas side joints (Φ15.9→Φ12.7)	Liquid side joints (Φ9.52→Φ6.35)	Heat insulation material	Adaptor
DXFQT2-02				Φ6.35→Φ9.52 (2 PC) Φ12.7→Φ15.9 (2 PC) Φ15.9→Φ19.1 (1 PC)
DXFQT3-02			 (Please cut off the excess)	Φ6.35→Φ9.52 (3 PC) Φ12.7→Φ15.9 (3 PC) Φ15.9→Φ19.1 (1 PC)
DXFQT4-02			 (Please cut off the excess)	Φ6.35→Φ9.52 (3 PC) Φ12.7→Φ15.9 (3 PC) Φ15.9→Φ19.1 (1 PC)
DXFQT5-02			 (Please cut off the excess)	Φ6.35→Φ9.52 (2 PC) Φ12.7→Φ15.9 (2 PC) Φ15.9→Φ19.1 (1 PC)
DXFQT6-02			 (Please cut off the excess)	Φ6.35→Φ9.52 (2 PC) Φ12.7→Φ15.9 (2 PC) Φ15.9→Φ19.1 (1 PC)

VRF AHU Control Box

High Efficiency

AHU kit facilitates raising the EER/COP of the complete AHU system.



Wide Capacity Range

Four kits can be used in parallel, giving an overall capacity range of 0.8-80HP.



Compatible with All VRF Systems

AHU kits are compatible with all Carrier VRF outdoor units and can be used together with all types of Carrier VRF indoor units.



Single AHU Control Box Connection

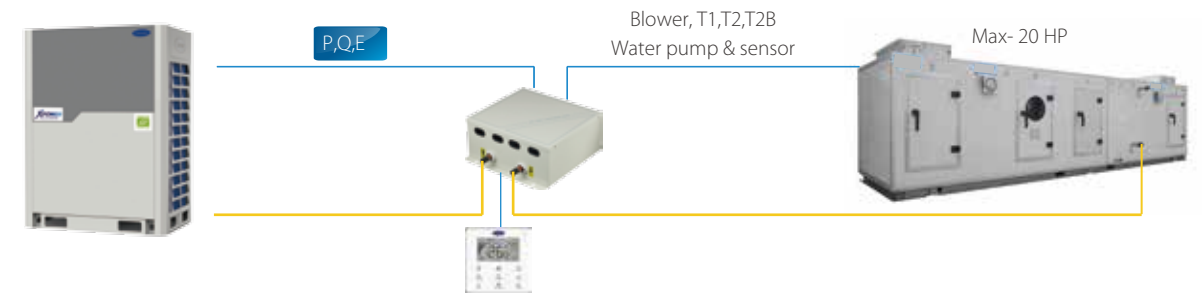

Multi AHU Control Boxes Connection

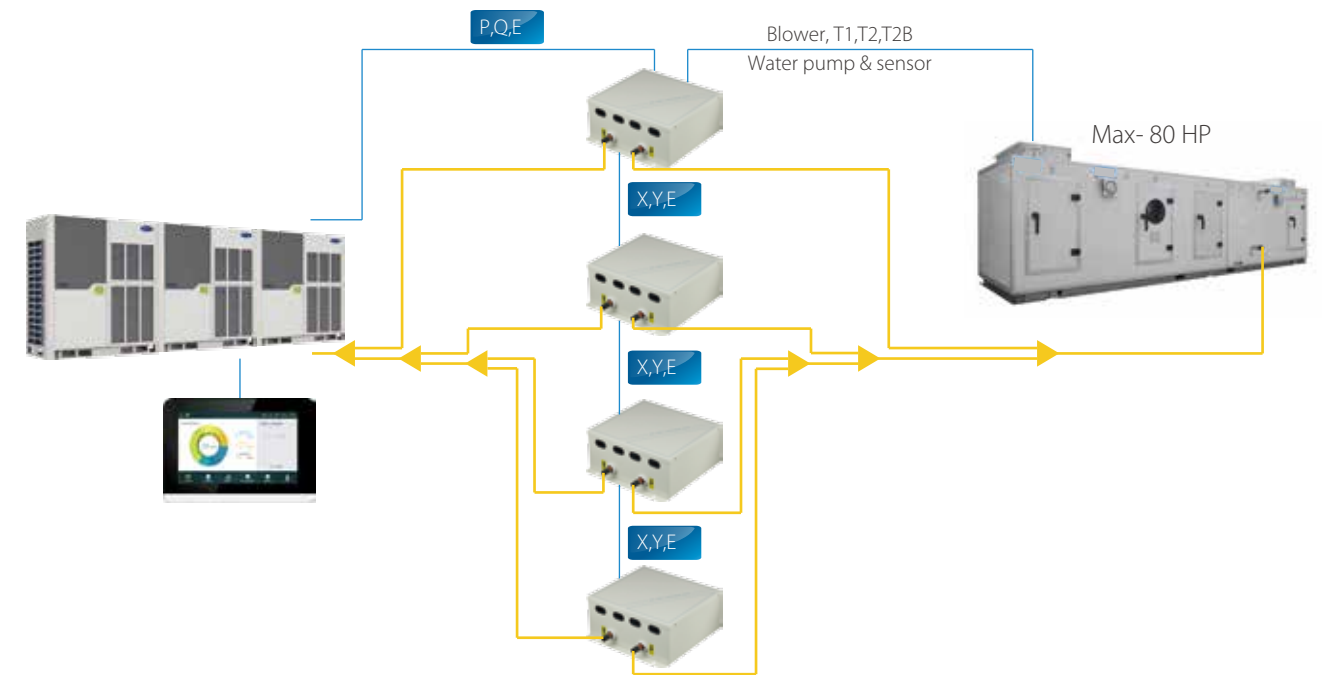

Specifications

Model name	AHUKZ-00D	AHUKZ-01D	AHUKZ-02D	AHUKZ-03D
Capacity A (kW)	2.2≤A<9	9≤A≤20	20<A≤36	36<A≤56
Power supply	220-240V~50/60Hz			
Liquid pipe (in/out) (mm)	Φ9.53/Φ9.53	Φ9.53/Φ9.53	Φ12.7/Φ12.7	Φ15.9/Φ15.9
Dimension (WxHxD) (mm)	341x133x395			
Weight (kg)	5.7	5.7	5.8	6.0
Operation range (cooling on coil) (oC)	17-43			
Operation range (heating on coil) (oC)	10-30			
Applicable outdoor units	Heat pump / heat recovery / cooling only			

Selection Software"CSSP"

High Efficiency

Carrier's advanced design automation tool can be used by designers, consultants and distributors to greatly reduce the time and effort that must be devoted to the selection process. The software provides quick and convenient selectable options for users, supports multiple languages, and greatly improves the selection process.

The Selection Software provides distributors' sales team with a comprehensive selection of system design reports and calculations. Load calculations may be on either an initial estimate basis or detailed room-by-room basis. Based on the indoor units, outdoor units and controllers selected, the software produces detailed system layout diagrams and piping requirement calculations.

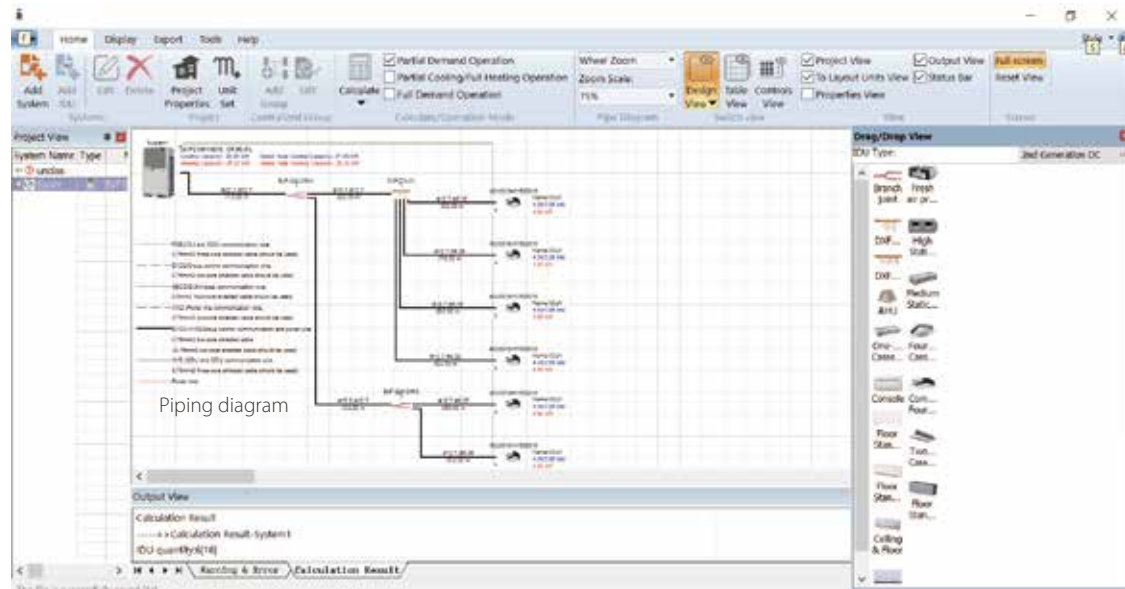

CAD View

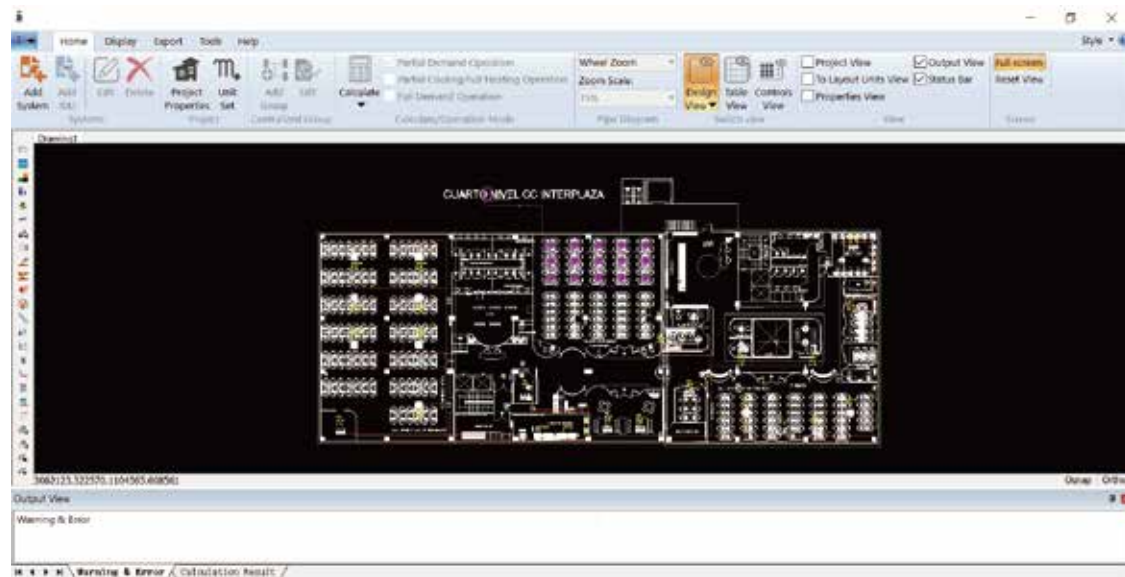

Compatible Table Of Control System

Outdoor Unit Series	Indoor Unit Series	1 st Generation (Remote Controllers/ Wired Controller/ KNX Gateway1)	1 st Generation Centralized Controllers	1 st generation BMS	2 nd Generation (Remote Controllers/ Wired Controller/ KNX Gateway1)	2 nd Generation Centralized Controllers	2 nd Generation BMS	Data Converter	Network Control System	Diagnosis Software	Accessories
Super X/ Super Xi	1st DC/AC	WR-29B-CM WL-12-CM WL-14-CM WR-120C-CM	CRF-40-CM WCRF-10-CM	NW-KNX-CM	/	CRF-180B-CM CRF-270C-CM	5GNS-BAC-CM NW-MOD-CM-A NW-LON-CM-A	CIF-15B-CM	CRF-270C-CM + 4GNS-20-IF or 5GNS-20-CM + 4GNS-20-IF	VRF-DIAG-B	CA-NIM05/E CA-NIM05B/E CA-NIM09
Super X/ Super Xi	2nd DC	/	/	/	WL-12F-CM WL-12B-CM WR-86KD-CM WR-120G-CM	CRF-180B-CM CRF-270C-CM	5GNS-BAC-CM NW-MOD-CM-A NW-LON-CM-A NW-KNXA-CM	CIF-15B-CM	CRF-270C-CM + 4GNS-20-IF or 5GNS-20-CM + 4GNS-20-IF	VRF-DIAG-B	CA-HKCW CA-HKCS CA-IS
Non Super X/ Super Xi	1st DC/AC	WR-29B-CM WL-12-CM WL-14-CM WR-120C-CM	CRF-40-CM WCRF-10-CM	CRF-18-CM NW-KNX-CM	/	CRF-180B-CM CRF-270C-CM	5GNS-BAC-CM NW-LON-CM-A	CIF-15B-CM	M-interface + IMM	VRF-DIAG-B	CA-NIM05/E CA-NIM05B/E CA-NIM09
Non Super X/ Super Xi	2nd DC	/	CRF-40-CM WCRF-10-CM	CRF-18-CM	WL-12F-CM WL-12B-CM WR-86KD-CM WR-120G-CM	CRF-180B-CM CRF-270C-CM	5GNS-BAC-CM NW-LON-CM-A NW-KNXA-CM	CIF-15B-CM	M-interface + IMM	VRF-DIAG-B	CA-HKCW CA-HKCS CA-IS

PURO - AIR KIT

SAFE INDOOR AIR, FROM THE INVISIBLE CARE
PURIFICATION SPEED INDUSTRY LEADER

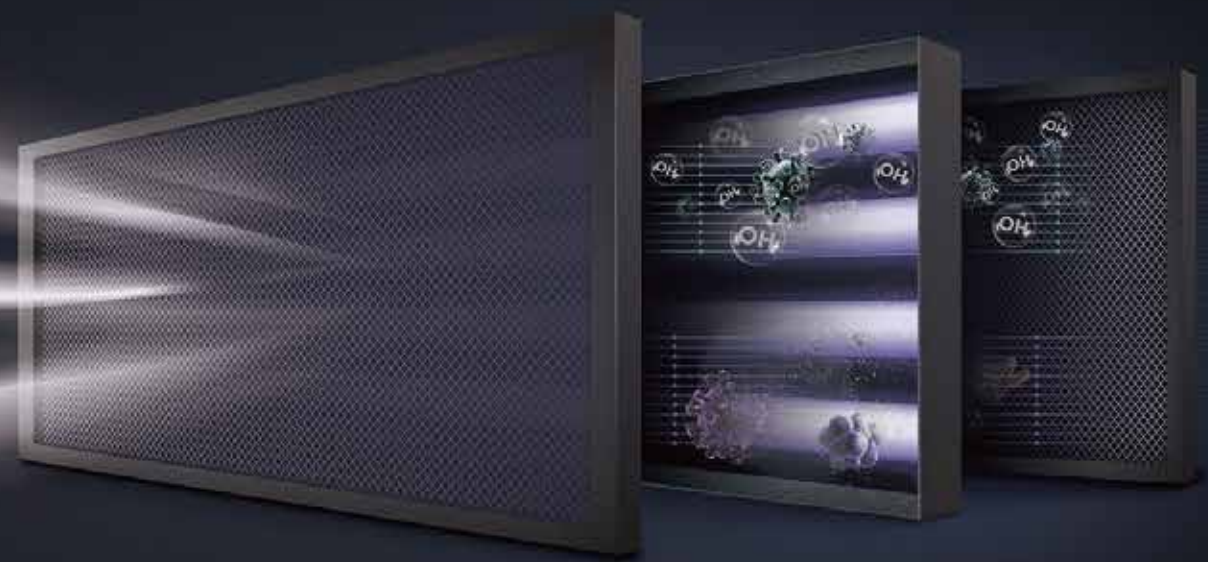

- 
UVGI
- 
CLEAN WAVE
- 
UV RADIATION FREE
- 
OZONE FREE



First Global Tick-mark Certification Of Purification Ac Products

Premium Osram Hns Uv Lamp Made In Europe

99.9% Killing Rate Of Staphylococcus Albus Within 10 Minutes

99.9% Killing Rate Of H1n1 Within 30 Minutes

98.2% Killing Rate Of Natural Airborne Bacteria Within 30 Minutes

Indoor air pollution is affecting our...

We spend 80% of our time indoors. On average, a person consumes about 8000 liters of air in a day. According to the EPA, indoor air pollution could be five times greater than outdoor air. Over 99% of particles in the air are smaller than 1 micron, and they cannot sink because of their lightweight. When a person sneezes, around 100,000 contagious germs may be sent into the air.

Puro-Air kit can effectively remove bacteria, viruses and odors from indoor air to provide a healthy and safe indoor environment. Its innovative design also prevents UV damage to the eyes, skin, and respiratory tract.

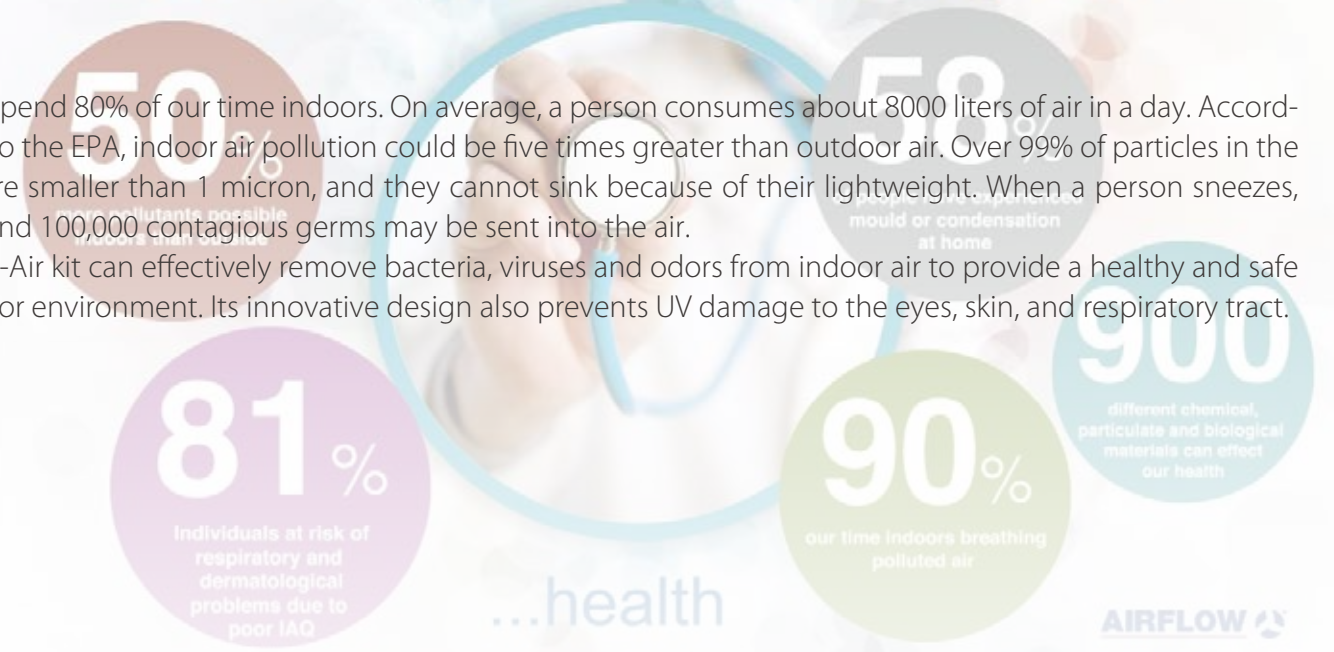

UVGI is increasingly widely used in the sterilization of HVAC equipment. W.J.Kowalski and others have obtained the effect of UV sterilization on the concentration of indoor pollutants through experiments. It can be seen that the virus, bacteria and spores exposed to UV irradiation with an intensity of 25 mW / cm² is significantly reduced. The results show that the microorganisms carried in the air can be killed by applying a certain intensity and time of UV irradiation (200-270nm) under appropriate conditions[1].

[1].HVAC Design Manual for Hospitals and Clinics, ASHRAE

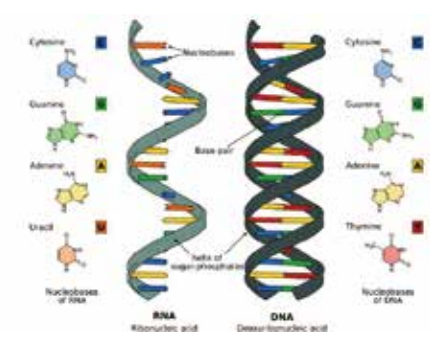

Andrea Bianco, Mara Biasin and others have confirmed through experiments that UV-C irradiation has the potential virucidal effects on SARS-CoV-2. The potential virucidal effects of UV-C irradiation on SARS-CoV-2 were evaluated for different illumination doses and virus concentrations. These results could explain the epidemiological trends of COVID-19 and are important for the development of novel sterilizing methods to contain SARS-CoV-2 infection[2]

[2]Refer to UV-C irradiation is highly effective in inactivating and inhibiting SARS-CoV-2 replication, Andrea Bianco, Mara Biasin

Features:

- 2 models, power range from 60W to 120W
- 2 UV lamps and 4 UV lamps are optional
- Application air flow rate of 2 UV lamps model can be up to 2600 m³/h
- Application air flow rate of 4 UV lamps model can be up to 4300 m³/h.
- UVGI high efficient
- Innovative structural design
- Higher safty,Ozone-free and UV leakage-free
- Flexibility Control
- Higher reliability
- Higher killing rate for viruses and bacteria,99.9% killing rate of Staphylococcus albus in 10 minutes,99.9% killing rate of H1N1and 98% killing rate of natural bacteria in 30 minutes
- Be widely used in many scenes



Precise 253.7nm UV wave length	Premium Ozone Free	Powerful 360° Coverage Area	Durable 9000hr 80% output	Reliable Solid Amalgam
---	------------------------------	--	--	-------------------------------------

Model	Description	Key component	Box size	Air flow(m ³ /h)
HFB1-P-U02	UV Health function box	2x(UV lamp,230V,30W)	BOXI	2600
HFB1-P-U04	UV Health function box	4x(UV lamp,230V,30W)	BOXI	4300

	BOX Dimension WxHxD(mm)	Air-flow(m ³ /h)	Air velocity(m/s)	Pressure loss(Pa)
HFB1 Puro-Air	1120x418x420	4000	2.44	65
		3500	2.13	50
		3000	1.86	40
		2500	1.52	30
		2000	1.19	20
		1500	0.94	12

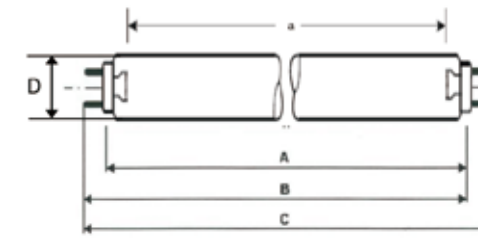

Geometric Data

Face to Face	A max 894.3 mm
Face to end of opposite pin	B min 899.3 mm
Face to end of opposite pin	B max 901.7 mm
Overall length	C max 908.8 mm
Radiation length	a 824 ± 2 mm
Tube diameter	D max 25.5 ± 2 mm
Base	G13

Electrical Data

Lamp Power	30 W
Lamp Voltage	96 V
Input Voltage	230 V

Note: The OSRAM HNS G13 lamp can be purchased from the market for replacement.

Spectral Data

Radiation flux (254nm)	12.0 W
Initial UV-C irradiance	> 0.31 W/m ² @ 2 meter
Lifetime	9000 hrs
UV-C irradiance @ 9000hrs	> 0.24 W/m ² @ 2 meter

Air Duct Installation

- The air inlet flange and air outlet flange are connected to air ducts, respectively.
- Seal the connection parts of the flange and air duct with aluminum foil tape.
- Use screws (prepared on site) to connect the air duct to the unit.

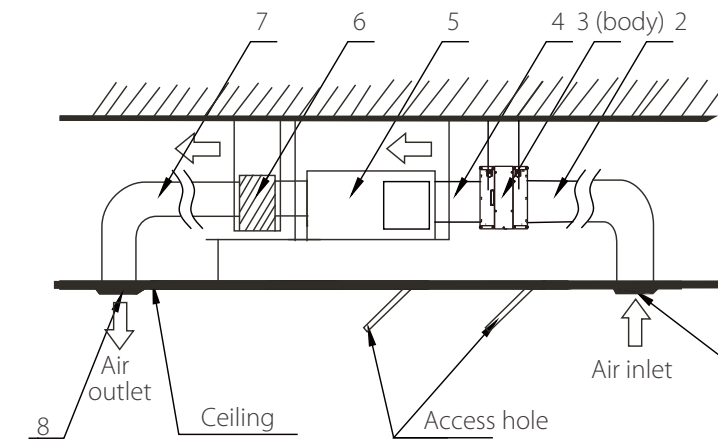

Legend	
1	Air inlet mesh(prepared on site)
2	Air outlet mesh(prepared on site)
3	PURO-AIR KIT
4	Air duct(prepared on site)
5	Master unit of the air conditioner
6	Air plenum(prepared on site)
7	Air outlet duct(prepared on site)
8	Air outlet(prepared on site)

Dimensions (mm)

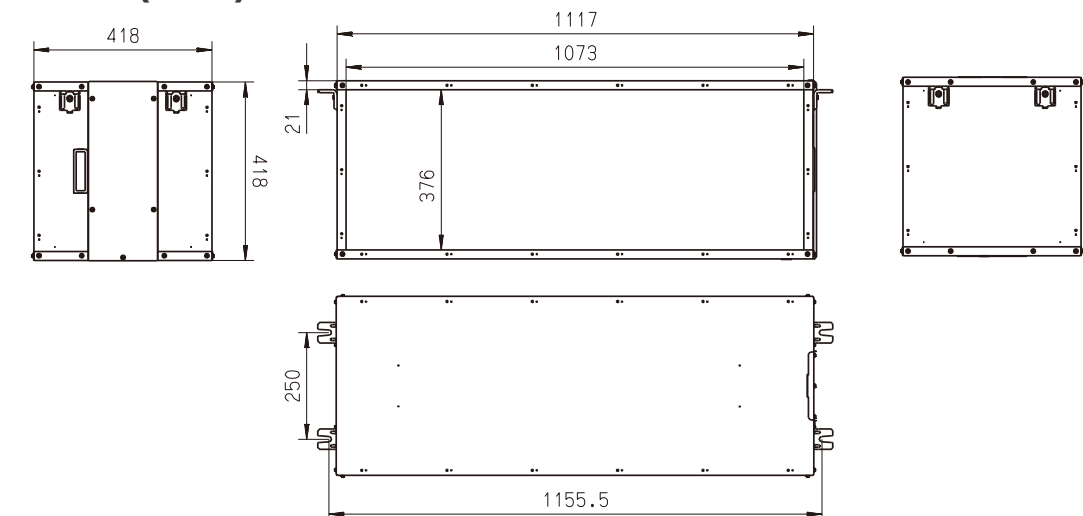

Heat Recovery Ventilator (HRV)

Wide Capacity Range

The HRV has AC Series and DC Series options. The airflow is from 200m³/h to 2000m³/h which can meet the requirements of most scenarios.



Energy Saving, Heat Recovery for Both Heat and Humidity

The heat recovery ventilator (HRV) can greatly reduce energy loss and room temperature fluctuations caused by the ventilation process. The Carrier HRV's strong performance is a result of the advanced technology incorporated into its design. The heat exchanger core is made of specially treated paper which gives enhanced temperature and humidity control. It prevents energy being wasted by recovering waste heat from the outgoing air, thus offering much greater levels of efficiency, while improving comfort levels too.

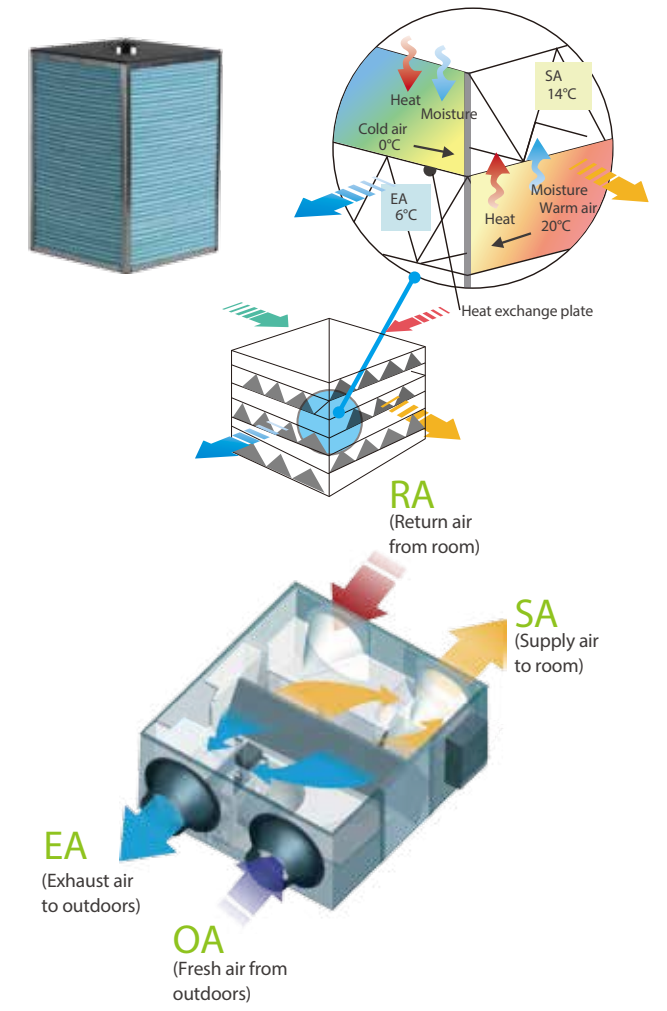

Multiple Operation Modes

Multiple operation modes: Auto, Bypass, Heat recovery, Free cooling mode (available for DC Series Only), Air supply mode and Exhaust mode (available for AC Series Only).

Heat exchange mode

The flows of incoming and outgoing air pass close to each other, allowing heat transfer between the two channels. During summer, incoming air is cooled by the indoor air being exhausted and in winter, incoming air is warmed.

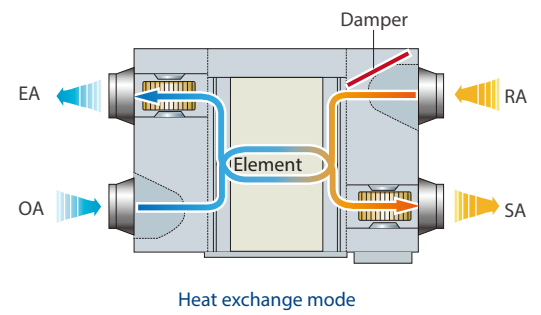

Bypass mode

In mild climates or seasons, where temperature and humidity differences between indoors and outdoors are small, the HRV can work as a conventional ventilation fan. In standard bypass mode the supply and exhaust fans run at the same speed.

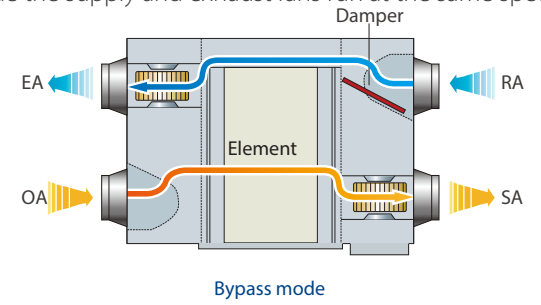

Air supply mode

Air supply mode is where the supply fan is set to run faster than the exhaust fan, which is useful in mild climate installations with high fresh air ventilation requirements.

Exhaust mode

Exhaust mode is where the exhaust fan is set to run faster than the supply fan, which is useful in mild climate installations with large amounts of exhaust air to be expelled.

Auto mode

The controller chooses heat exchange mode or bypass mode according to the temperature difference between outdoors and indoors. Both fans are set to run at low speed.

Free Cooling Mode

Free cooling mode is only available for DC Series HRV. Free cooling operation is an energy saving function operating when outdoor ambient temperature is below indoor ambient temperature, it uses low temperature fresh air to cool down indoor temperature, reducing the running costs.

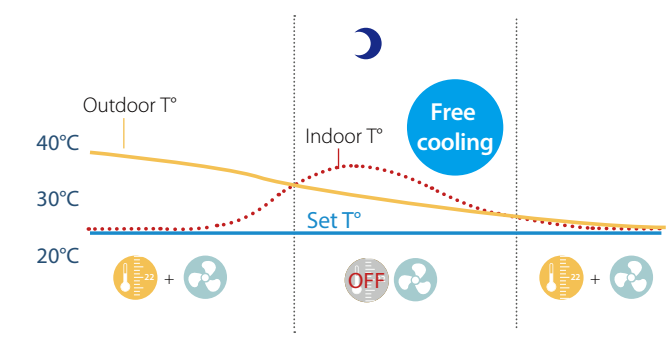

High Efficiency Filter

Standard Built-in G4-class dust filter, optional F7-class filter for air supply side and M5-class filter for exhaust air side in line with EU legislations can be customized.



CO₂ Sensor Option

Enough fresh air is needed to create an enjoyable environment, but ventilating constantly is leading to energy waste. Therefore, an optional CO₂ sensor can be installed which switches off the ventilation system when there is enough fresh air in the room, thus saving energy.

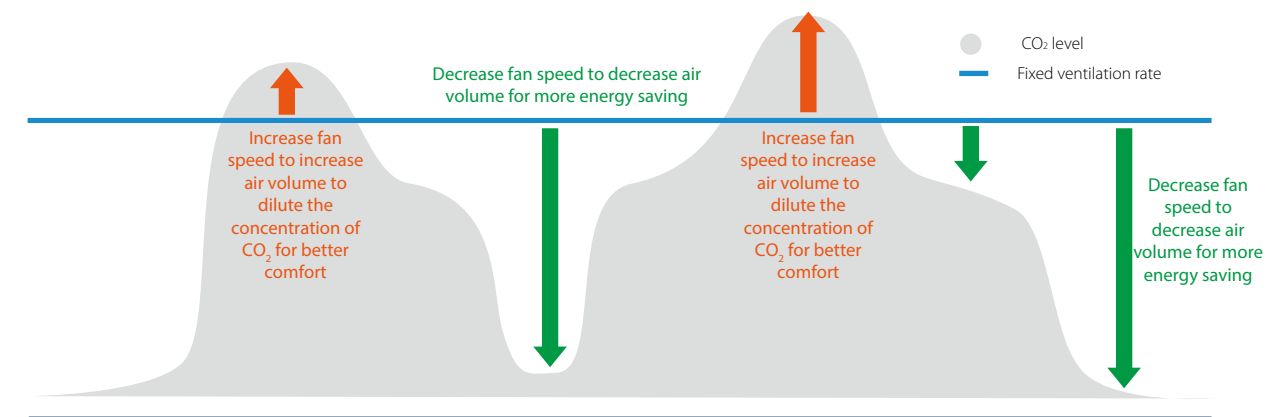

Easy Installation

Slim and compact design of units, making the installation more convenient.

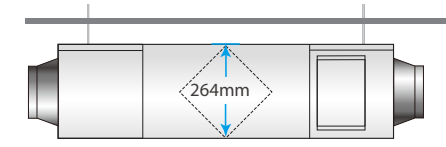

Wide Range of Controllers

The HRV is compatible with group controller WR-120G-CM for new functions (CO₂ sensor function, differential pressure sensor function) control. It also can be centralized control with VRF system through centralized controller and network control with VRF system through CarrierBMS gateways.



Specifications - DC Series

Model		SA-HRV-D200(B)	SA-HRV-D300(B)	SA-HRV-D400(B)	SA-HRV-D500(B)
Power supply		220-240V 1Ph 50Hz&208-230V 1Ph 60Hz			
Input power (H/M/L)(F7+M5)	W	80/40/25	100/55/35	110/70/40	150/95/50
Nominal Temperature Efficiency (standard G4) (H/M/L)	%	79.5/81.0/83.5	75.5/78.8/82.5	77.7/79.0/81.3	80.6/82.2/85.5
Nominal Enthalpy Efficiency (standard G4) (H/M/L)	%	75.0/77.5/79.6	72.1/75.0/79.3	73.5/75.3/78.0	74.0/76.6/80.5
Nominal Temperature Efficiency (F7+M5) (H/M/L)	%	81.8/85.4/87.5	80.4/81.8/83.5	79.2/81.1/83.3	77.2/79.4/82.5
Nominal Enthalpy Efficiency (F7+M5) (H/M/L)	%	81.2/83.1/85.0	79.4/81.2/84.0	79.6/81.8/84.2	72.3/75.6/78.6
Fresh air external static pressure (H speed +F7+M5)	Pa	75	70	70	65
Discharge air external static pressure (H speed +F7+M5)	Pa	100	110	110	110
Nominal air flow	m ³ /h	200	300	400	500
Sound pressure level (H/M/L)	dB(A)	34/29.1/23.5	35.5/30.2/25.1	39/33.8/29	36.5/32.2/27.7
Sound power level (H)	dB	45	48	48	50
Net dimensions (WxDxH)	mm	1195x801x272	1195x914x272	1276x1204x272	1311x1106x390
Packed dimensions (WxDxH)	mm	1275x880x420	1275x994x420	1360x1284x420	1390x1244x540
Net/Gross weight	kg	46.5/63.5	56.5/75.5	71.5/91.5	76/98
Duct diameter	mm	Φ144	Φ144	Φ198	Φ244
Operating temperature range	°C	-7 to 43 DB, RH 80% or lower			

Model		SA-HRV-D800(B)	SA-HRV-D1000(B)	SA-HRV-D1500(B)	SA-HRV-D2000(B)
Power supply		220-240V 1Ph 50Hz&208-230V 1Ph 60Hz			
Input power (H/M/L)(F7+M5)	W	320/170/80	420/230/100	680/320/200	950/500/230
Nominal Temperature Efficiency (standard G4) (H/M/L)	%	78.7/82.1/86.8	82.8/84.0/87.4	75.5/78.6/80.2	77.2/79.5/83.4
Nominal Enthalpy Efficiency (standard G4) (H/M/L)	%	72.3/75.4/79.0	76.0/76.0/80.1	69.4/71.2/74.8	74.7/77.0/80.6
Nominal Temperature Efficiency (F7+M5) (H/M/L)	%	74.9/77.1/80.8	75.4/78.0/81.4	83.8/84.6/86.2	78.8/80.5/83.4
Nominal Enthalpy Efficiency (F7+M5) (H/M/L)	%	71.1/74.4/78.0	67.3/71.1/75.0	74.6/76.2/78.8	71.1/75.0/79.6
Fresh air external static pressure (H speed +F7+M5)	Pa	100	110	150	160
Discharge air external static pressure (H speed +F7+M5)	Pa	155	145	180	180
Nominal air flow	m ³ /h	800	1000	1500	2000
Sound pressure level (H/M/L)	dB(A)	48.5/43.1/36.4	50.2/44.8/37	52.5/47.8/43.5	54.1/49.2/43.3
Sound power level (H)	dB	55	54	69	70
Net dimensions (WxDxH)	mm	1311x1286x390	1311x1526x390	1740x1375x615	1811x1575x685
Packed dimensions (WxDxH)	mm	1390x1424x540	1390x1670x540	1830x1520x770	1900x1720x845
Net/Gross weight	kg	80/104	90/112	181.5/213	208.5/245
Duct diameter	mm	Φ244	Φ244	346x326	346x326
Operating temperature range	°C	-7 to 43 DB, RH 80% or lower			

Note:

- For the units model of HRV-D200(B)~HRV-D2000(B), there are 3-speed adjustable air-volume (Hi, Med, Low).
- The parameters in the above table are measured at high speed.

Specifications - AC Series

Model		HRV-200	HRV-300	HRV-400/ SA-HRV-400	HRV-500/ SA-HRV-500
Power supply		1-phase, 220-240V~50Hz		1-phase, 220-240V~50Hz / 1-phase, 220V~60Hz	
Cooling temp. exchange efficiency (H/M/L)	%	55/55/60	55/55/60	55/55/60	55/55/60
Cooling enthalpy exchange efficiency (H/M/L)	%	50/50/55	50/50/55	50/50/55	50/50/55
Heating temp. exchange efficiency (H/M/L)	%	60/60/65	60/60/65	60/60/65	65/65/70
Heating enthalpy exchange efficiency (H/M/L)	%	55/55/60	55/55/60	60/60/65	60/60/65
Sound pressure level in heat exchange mode (H/M/L)	dB(A)	27/26/20	30/29/23	32/31/25	35/34/28
Sound pressure level in bypass mode (H/M/L)	dB(A)	28/27/22	31/30/25	33/32/27	36/35/30
Airflow rate (H/M/L)	m ³ /h	200/200/150	300/300/225	400/400/300	500/500/375
External static pressure (H/M/L)	Pa	75/58/35	75/60/40	80/65/43	80/68/45
Motor type		AC			
Duct diameter	mm	Φ144	Φ144	Φ144	Φ194
Net dimensions (WxDxH)	mm	866x655x264	944x722x270	944x927x270	1038x1026x270
Packed dimensions (WxDxH)	mm	960x770x445	1020x810x452	1020x1020x452	1120x1120x452
Net weight	kg	23	26	31	41
Gross weight	kg	40	44	52	64
Operating temperature range	°C	-7 to 43 DB, RH 80% or lower			

Model		HRV-800/ SA-HRV-800	HRV-1000/ SA-HRV-1000	HRV-1500	HRV-2000
Power supply		1-phase, 220-240V~50Hz / 1-phase, 220V~60Hz		3-phase, 380-415V~50Hz	
Cooling temp. exchange efficiency (H/M/L)	%	55/55/60	55/55/60	55	55
Cooling enthalpy exchange efficiency (H/M/L)	%	50/50/55	50/50/55	50	50
Heating temp. exchange efficiency (H/M/L)	%	65/65/70	65/65/70	65	65
Heating enthalpy exchange efficiency (H/M/L)	%	60/60/65	60/60/65	60	60
Sound pressure level in heat exchange mode (H/M/L)	dB(A)	39/38/32	40/39/33	51	53
Sound pressure level in bypass mode (H/M/L)	dB(A)	40/39/34	41/40/35	52	54
Airflow rate (H/M/L)	m ³ /h	800/800/600	1000/1000/750	1500	2000
External static pressure (H/M/L)	Pa	100/82/54	100/85/58	160	170
Motor type		AC			
Duct dimensions	mm	Φ242	Φ242	346x326	346x326
Net dimensions (WxDxH)	mm	1286x1006x388	1286x1256x388	1600x1270x540	1650x1470x540
Packed dimensions (WxDxH)	mm	1380x1100x573	1400x1370x573	1710x1410x720	1760x1610x720
Net weight	kg	62	79	163	182
Gross weight	kg	88	110	224	247
Operating temperature range	°C	-7 to 43 DB, RH 80% or lower			

Note:

- Models HRV-200 to HRV-1000 each have have 3 airflow settings; the airflow rates of the HRV-1500 and HRV-2000 are not adjustable.
- Sound level is measured 1.4m below the center of the unit in a semi-anechoic chamber.
- Efficiency is measured under the following conditions:
Cooling: exhaust air temp 27°C DB, 19.5°C WB; fresh air temp. 35°C DB, 28°C WB.
Heating: exhaust air temp 21°C DB, 13°C WB; fresh air temp. 5°C DB, 2°C WB.

Controller Optional

Optional wireless remote controller



WL-14-CM WL-12-CM

Standard wired controller



WR-29B-CM
(Factory recommend)



Model		40VM018H115003010		40VM024H115003010		40VM030H115003010		40VM036H115003010		40VM048H115003010		40VM054H115003010	
Power supply		V- Ph-Hz		1 phase, 208-230V,60Hz									
Cooling	Capacity	kW	5.3	7.1	9	10.5	14	16					
		kBtu/h	18	24	30	36	48	54					
	Input	W	220	290	390	350	590	700					
Heating	Capacity	kW	8	9	10	12.5	16	17					
		kBtu/h	21	27	34	40	54	60					
	Input	W	220	290	390	350	590	700					
Indoor air flow (H/M/L)		m ³ /h	1100/930/780	1360/1240/1020	1700/1480/1275	2040/1785/1530	2700/2300/1900	3000/2600/2100					
		CFM	650 / 550 / 460	800 / 730 / 600	1000 / 870 / 750	1200 / 1050 / 900	1600 / 1360 / 1120	1800 / 1530 / 1260					
Indoor noise level (H/M/L)		dB(A)	48 / 45 / 43	49 / 47 / 43	52 / 49 / 47	53 / 50 / 47	57 / 54 / 52	58 / 57 / 55					
Indoor unit	Dimension (WxHxD)	mm	500x1180x550	500x1180x550	500x1180x550	560x1385x610	560x1385x610	560x1385x610					
	Packing (WxHxD)	mm	567x1274x644	567x1274x644	567x1274x644	627x1479x704	627x1479x704	627x1479x704					
	Net/Gross weight	kg	55.7/66.6	55.7/66.6	55.7/66.6	73.8/86	73.8/86	73.8/86					
Refrigerant piping	Liquid / Gas	mm	Φ9.53/ Φ15.9	Φ9.53/ Φ15.9	Φ9.53/ Φ15.9	Φ9.53/ Φ15.9	Φ9.53/ Φ15.9	Φ9.53/ Φ15.9					
Drainage water pipe diameter		OD Φ19.05											

Notes:

- Indoor temperature 27°C DB, 19°C WB; outdoor temperature 35°C DB; equivalent refrigerant piping length 7.5m with zero level difference.
- Indoor temperature 20°C DB; outdoor temperature 7°C DB, 6°C WB; equivalent refrigerant piping length 7.5m with zero level difference.
- Each model's 7 airflow rate options are listed in order, from highest to lowest.
- Each model's 7 sound pressure levels are listed in order from highest to lowest and correspond to the model's 7 airflow rate options (see Note 3).
Sound pressure level is measured 1m in front and 1m above the floor in a semi-anechoic chamber.
- Unit body dimensions given are the largest external dimensions of the unit, including hanger attachments.

Branch Pipe

Model	Appearance	Model name	Packing Size (mm)	Gross Weight (kg)	Description
Super X Series		BJC-02E-CM(i)	255x150x185	2.0	Connecting two outdoor units
		BJC-03E-CM(i)	345x160x285	4.3	Connecting three outdoor units
Super Plus Series		BJC-02-CM(i)	255x150x185	1.5	For two outdoor units connection
		BJC-03-CM(i)	345x160x285	3.4	For three outdoor units connection
		BJC-04-CM(i)	475x165x300	4.8	For four outdoor units connection
		BJC-04-CM(i)	475x165x300	4.8	For four outdoor units connection

A*:The total capacity of indoor units which is connected to this branch joint

Type	Appearance	Model	Packed Dimensions mm	Gross Weight kg	Note
Branch joints for indoor units		BJF-224-CM(i)	290x105x100	0.4	/
		BJF-330-CM(i)	290x105x100	0.6	/
		BJF-710-CM(i)	310x130x125	0.9	/
		BJF-1344-CM(i)	350x180x170	1.5	/
		BJF-E1344-CM(i)	365x195x215	1.9	/
		BJF-E1500-CM(i)	390x230x255	3.1	/
		BJF-E2690-CM(i)	390x230x255	3.4	/

Dimensions

Outdoor Branch Joints

Model	Gas side joints	Liquid side joints
BJC-02E-CM(i)		
BJC-03E-CM(i)		
BJC-04-CM(i)		

Model	Gas side joints	Liquid side joints
BJC-02-CM(i)		
BJC-03-CM(i)		
BJC-04-CM(i)		

Dimensions

Indoor Branch Joints

Model	Gas side joints	Liquid side joints
BJF-224-CM(i)		
BJF-330-CM(i)		
BJF-710-CM(i)		
BJF-1344-CM(i)		
BJF-E1344-CM(i)		
BJF-E1500-CM(i)		
BJF-E2690-CM(i)		