



**AEROEDGE™**

## 39CQ Air Handling Unit

Air flow: 2000~110000m<sup>3</sup>/h



## Turn To The Experts

Carrier is a leading global provider of innovative HVAC, refrigeration, fire, security and building automation technologies.

Supported by the iconic Carrier name, the company's portfolio includes industry-leading brands such as Carrier, Kidde, Edwards, LenelS2 and Automated Logic.

Carrier's businesses enable modern life, delivering efficiency, safety, security, comfort, productivity and sustainability across a wide range of residential, commercial and industrial applications.



In 1998, Time magazine named Dr. Carrier one of its 20 most influential builders and titans of the 20<sup>th</sup> century.



## Identification & Dimension

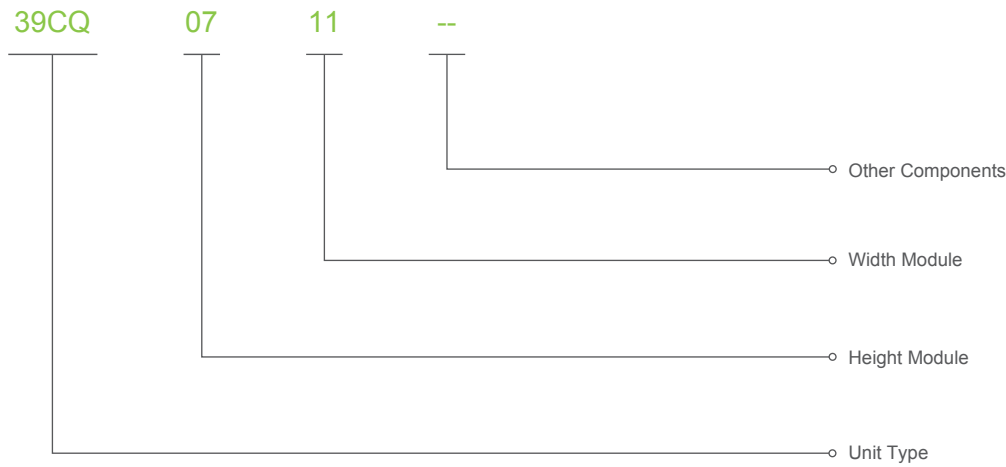

General rule of the height, width and length of a section or unit can be determined with the module concept:

A. 39CQ 0608~2735

(1) Unit Height = Height Module×100+90+100(base)

(2) Unit Width = Width Module×100+90

Example: 39CQ 0711

07 Height Module

Unit Height: 7×100+90+100 (base) =890mm

11 Width Module

Unit Width: 11×100+90=1190mm

B. 39CQ 2832~3438

31 Height Module

Unit Height: 31×100+90+200 (base) =3390mm

32 Width Module

Unit Module: 32×100+90=3290mm

## Unit orientation

Unit Orientation is determined by the location of the inlet and outlet pipes of the coil and the access panel while facing unit in the direction of air flow.

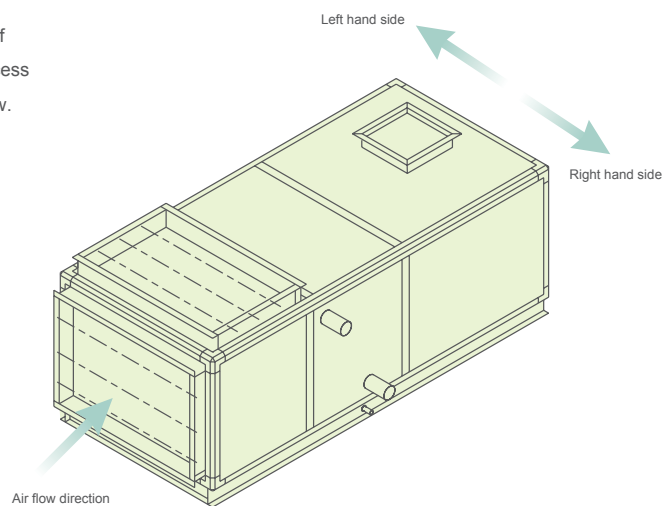

## Air volume

39CQ: 2000~110000m<sup>3</sup>/h

## Superior casing performance

### T2/TB2/L1(M)/D1(M)/F9(M)

#### Excellent airtightness

The casing is made up of panels, frame and sealing strips. New casing structure of the unit avoids that any of the interior support member is exposed and ensures smooth internal surface, easy for cleaning and maintenance. New type of sealing strips between the frame and the panels, and careful sealing design to all access panels and locations passing-through pipes ensure excellent air tightness of the units.

#### Thermal bridge free

Carrier unique frame design enables pentapost and interpost covered by panel to prevent exposing in treated air, so the thermal bridge at posts is avoided. Each junction is subjected to special heat insulation treatment to prevent the thermal bridge effect. New design of screw also prevents the occurring of thermal bridge at screws, contributes to better casing performance.

#### Optimal thermal insulation

The middle layer of the unit panels is a 50mm thick PU foam with light weight, good rigidity, and thermal conductivity. Moreover, special insulation treatment is conducted at the inner parts of the frame and the middle frame strips to eliminate thermal transmission through the casing.

## Access and serviceability design

#### Integrated control system

Factory assemble integrated control system with touch screen displayer saves installation and maintenance cost and ensures optimal operation.

#### Modular design convenient to select

The width, height and length of the unit are proportionally increased with 100mm as module. Each air volume corresponds with a certain unit type. Standard modular products make modeling and manufacturing faster and more convenient.

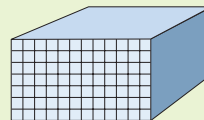

#### Double skin panel construction

Pre-painted panel as standard configuration of external panel, high durability (HDP) painted panel can be optional, ensure good rust preventive performance. Galvanized steel is standard for interior panel, and stainless steel sheet is also available.

#### Unit base

Each section has a base, which enhances the strength of the whole unit, reduces vibration, and make it easy to transport and assemble.

#### Easy maintenance

All basic component parts are standard and interchangeable with competitive prices. The unit is designed to have removable panels on its one side, and the access panels are arranged in the necessary components, providing convenience for repair and maintenance of the fan, coil and filter. The coil is installed on the guide rail inside the drain pan, enabling easy maintenance, cleaning and removal.

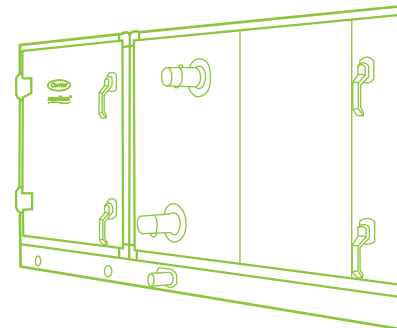

## Various filters available to meet different needs

A complete line of filters is available, the levels of filters are ranging from primary filters (Panel type, filter class up to G4), to medium filters (Bag type, filter class up to F9), and to high filters (filter class up to H13). Some special filters such as activated-carbon filters, cartridge filters and electronstatic filters can also be provided.

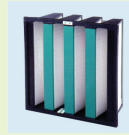

High efficiency filter



Bag filter



Panel filter

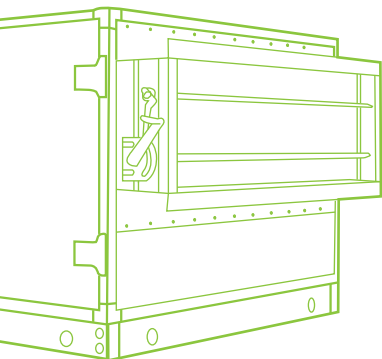

## Flexible application

### Optimized design, high efficiency and vibration-free operation

The fan impeller and pulley are statically and dynamically balanced, and the whole fan is calibrated through the operational vibration testing, making the fan to operate stably and smoothly. With the fan and motor assembly mounted on a common base with shock absorber and the fan outlet isolated from the casing by a flexible connection and completely separated from moving parts, the vibration is effectively isolated. Moreover, the forward or backward impeller may be selected according to the air pressure and volume.

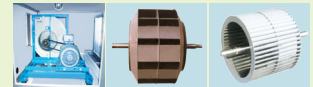

### Hot and cold water coils designed according to international standard

Fins are the "dual sine-wave" form and mechanically bonded with copper tubes, realizing excellent heat transfer efficiency. Hydrophilic aluminum foils may also be utilized to achieve better heat transfer performance. The standard coil header is constructed of steel and can also be customized with lopper.



Headers have drain and vent connections, so coil is drainable and has non air trapping circuits. The water in the coil must be discharged in winter to avoid the frost crack of the coil.

If the coil face air velocity is higher than 2.5m/s, a drift eliminator can be installed on the back of the coil to effectively isolate moisture in air.

### Corrugated damper flexible to adjust

With manual or electric mode available, the corrugated linkage damper can be opened flexibly, and can also add an electric controller as required.

### Various heat recovery options

To improve indoor air quality is generally accomplished by introducing ventilation from outdoors. The air must be conditioned to match the indoor space. Carrier energy saving solution offer options for energy-recovery wheels, air-to-air heat exchangers, heat pipes, or coil-run-around loops. These proven technologies economically transfer energy between the exhaust-air and fresh-air paths, reducing the cost of conditioning the fresh air.

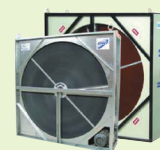

Heat wheels



Heat plate

## Efficient and durable PM2.5 solution

Related researches show that indoor and outdoor pollutants are the most important contributory factor of diseases related to the environment. Air contaminants: particles, sulphur dioxide, ozone and nitrogen dioxide have serious effects on health particles, especially for particles below 2.5µm. Clear connection between increased pollution levels with particles below 2.5µm and increased mortality caused by cardiovascular and respiratory illness.

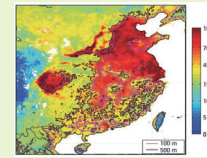

Satellite-derived PM<sub>2.5</sub> (µg/m<sup>3</sup>)

Carrier new efficient and durable PM2.5 filter using the latest nano filtration media, responds to criteria of new EN779 standard (F7 – F9 range), high efficiently filter out PM2.5 and other air pollutants, providing you with a clean and healthy indoor environment.

### Efficient and stable filtration performance, PM2.5 removal efficiency up to 90%\*

Carrier PM2.5 filter using the latest nano filtration media, purely mechanical filtration principle, Media is not charged – no charge dissipation and media performance remains intact for PM 2.5 µm particles. Common synthetic filter with electrostatic charged media, static electricity continue to disappear during use, filtration efficiency will drop sharply, so it need to be replaced frequently.\*

\*Includes all particle of 0.1~2.5µm diameter

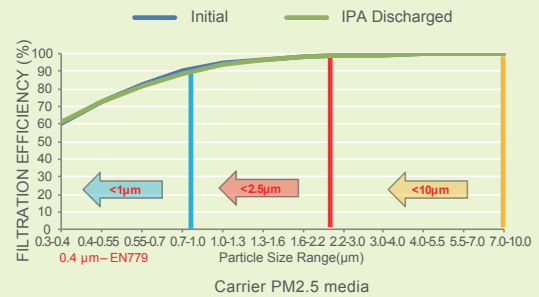
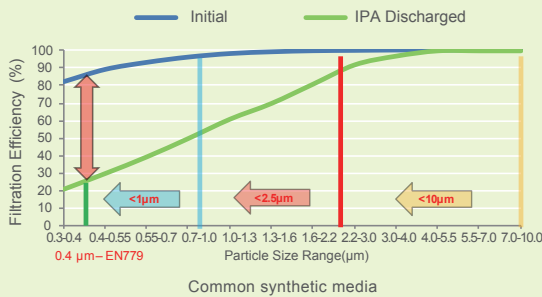

### More than double the dust load capacity – longer life

Combining fine fiber and filtration surface, fine fiber with greatly increased surface area and double the dust load capacity in the media. Compared with normal synthesis filter, PM2.5 filter has longer lifetime, reducing the routine maintenance costs.

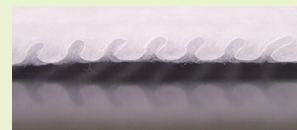

### Lower energy consumption, superior energy classification according to Eurovent 4/11

Under the same efficiency level, the initial pressure drop of Carrier new PM2.5 filter is 35% lower than that of glass mat. Lower pressure drop, lower energy consumption.

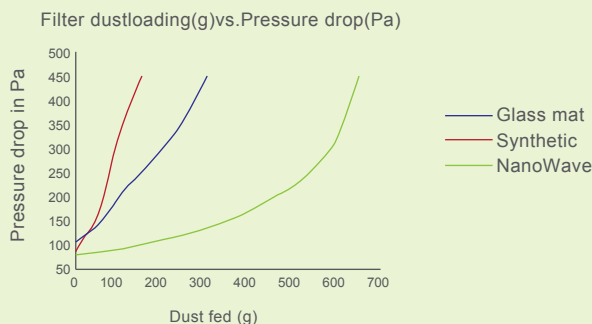

Energy		Air Filter
Manufacturer Model	Logo	XV2
A		
B		
C		
D		
E		
F		
G		
Yearly Energy consumption, kWh per annum at nominal flow rate (the actual energy consumption depends on the operating conditions)	900	
Energy efficiency rating value, kWh m <sup>-3</sup> m <sup>2</sup>	710	
Filter class to EN 779	F7	
Nominal flow rate in m <sup>3</sup> /h	4250	

## Quick selection

Model	Rating air volume m <sup>3</sup> /h	Coil face Area (m <sup>2</sup> )	Air Volume (m <sup>3</sup> /h)			Inside Dimension of Damper mm*mm	Unit Dimension (mm)	
			Face Velocity				Height	Width
			2.25m/s	2.5m/s	2.75m/s			
39CQ0608	2000	0.23	1863	2070	2277	756*322.5	690	890
39CQ0609	3000	0.32	2592	2880	3168	856*322.5	690	990
39CQ0711	4000	0.46	3726	4140	4554	1056*322.5	790	1190
39CQ0811	5000	0.57	4617	5130	5643	1056*322.5	890	1190
39CQ0912	6000	0.69	5589	6210	6831	1156*322.5	990	1290
39CQ0913	7000	0.76	6156	6840	7524	1256*480	990	1390
39CQ0914	8000	0.84	6804	7560	8316	1356*480	990	1490
39CQ1015	10000	1.06	8586	9540	10494	1456*480	1090	1590
39CQ1117	12000	1.31	10611	11790	12969	1656*480	1190	1790
39CQ1317	15000	1.68	13608	15120	16632	1656*480	1390	1790
39CQ1418	18000	1.90	15390	17100	18810	1756*637.5	1490	1890
39CQ1420	20000	2.14	17334	19260	21186	1956*637.5	1490	2090
39CQ1621	25000	2.62	21222	23580	25938	2056*637.5	1690	2190
39CQ1822	30000	3.26	26406	29340	32274	2156*795	1890	2290
39CQ1825	32000	3.75	30375	33750	37125	2456*795	1890	2590
39CQ2025	35000	4.04	32724	36360	39996	2456*795	2090	2590
39CQ2125	40000	4.33	35073	38970	42867	2456*952.5	2190	2590
39CQ2226	45000	4.82	39042	43380	47718	2556*952.5	2290	2690
39CQ2328	50000	5.39	43659	48510	53361	2756*952.5	2390	2890
39CQ2330	55000	5.81	47061	52290	57519	2956*952.5	2390	3090
39CQ2333	60000	6.44	52164	57960	63756	3256*952.5	2390	3390
39CQ2435	65000	7.22	58482	64980	71478	3456*952.5	2490	3590
39CQ2635	70000	7.84	63504	70560	77616	3456*952.5	2690	3590
39CQ2735	75000	8.26	66906	74340	81774	3456*952.5	2790	3590
39CQ2832	80000	8.97	72657	80730	88803	3156*952.5	2890	3290
39CQ3132	90000	9.89	80109	89010	97911	3156*1267.5	3190	3290
39CQ3438	110000	12.16	98496	109440	120384	3756*1267.5	3490	3890

Note: 1. The unit height does not included the damper on the top and the base of 100mm(0608-2735)/200mm(2832-3438).  
2. Above table is just for your reference. Please refer Carrier AHU selection software for detail information.

## Software

### Computer Selection

Our company provides the double-quick and accurate computer selection. We will get the reasonable and economic unit by working out the optimal function configuration to meet the customer's requirement.

### Functions & Features

- ✔ Project Management
- ✔ Modular Designer
- ✔ Free Section Combining
- ✔ Section & Option Configuration
- ✔ Shipping Configuration
- ✔ Performance Calculation
- ✔ Quotation
- ✔ Drawings & Tech Specification
- ✔ Multilingual & Friendly Interface

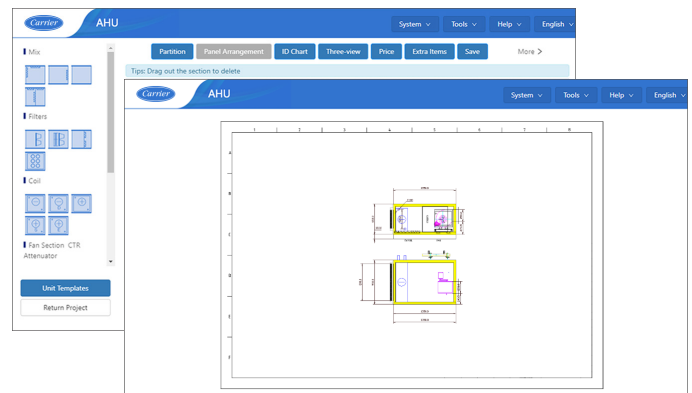

## Electric heater selection

No.	Unit Model	Face Area	1 Row Heater	2 Row Heater	3 Row Heater
	Unit Size	(m <sup>2</sup> )	Power range (kW)	Power range (kW)	Power range (kW)
1	39CQ0608	0.21	< 4	4~8	8~12
2	39CQ0609	0.25	< 5	5~10	10~15
3	39CQ0711	0.42	< 7	7~14	14~21
4	39CQ0811	0.49	< 11	11~22	22~33
5	39CQ0912	0.65	< 13	13~26	26~39
6	39CQ0913	0.72	< 15	15~30	30~45
7	39CQ0914	0.80	< 17	17~34	34~51
8	39CQ1015	0.99	< 24	24~48	48~72
9	39CQ1117	1.29	< 28	28~56	56~84
10	39CQ1317	1.56	< 35	35~70	70~105
11	39CQ1418	1.83	< 38	38~76	76~114
12	39CQ1420	2.08	< 43	43~86	86~129
13	39CQ1621	2.55	< 45	45~90	90~135
14	39CQ1822	3.07	< 58	58~116	116~174
15	39CQ1825	3.56	< 70	70~140	140~210
16	39CQ2025	4.00	< 80	80~160	160~240
17	39CQ2125	4.21	< 90	90~180	180~270
18	39CQ2226	4.63	< 95	95~190	190~285
19	39CQ2328	5.29	< 100	100~200	200~300
20	39CQ2330	5.72	< 105	105~210	210~315
21	39CQ2333	6.36	< 120	120~240	240~360
22	39CQ2435	7.11	< 125	125~250	250~375
23	39CQ2635	7.74	< 140	140~280	280~420
24	39CQ2735	8.06	< 140	140~280	280~420
25	39CQ2832	7.24	< 160	160~320	320~480
26	39CQ3132	8.15	< 175	175~350	350~525
27	39CQ3438	10.56	< 225	225~450	450~675

Note: 1. Star connection is used in the wiring of electric heaters. Multi-group control is available, in which the capacity for each group is generally 30kW or less.

The power supply is 3-phase 380V.











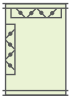







2. Minimum air velocity is 2m/s.

3. 3M module holds maximum of 3 row heater.















4. Capacity exceeding 3 row should choose two separated heaters in 6M module section.



## Standard components (0608~2735)

No.	Unit Section	Diagram	Section Length (M: Module)	Remark
1	Return/Mixing Chamber		(0608~0912) 5M (0913~1317) 6M (1418~1621) 8M (1822~2025) 9M (2125~2333) 11M (2435~2735) 12M	
2	Single Filter (panel/bag)		3/4/5/6/8/9M	Access section is recommended at upstream
3	Combined Filter		3/4/5/6/8/9M	Access section is recommended at upstream
4	Cooling Coil		5M or 6M	The section length is 5M with drift eliminator and 6M without drift eliminator
5	Heating Coil		3M	May be installed together with the cooling coil if this cooling coil does not include a film humidifier and a drift eliminator
6	Steam Heating Coil		3M	
7	Electric Heating Coil		3M	
8	Steam Humidifier		6M	
9	Film Humidifier		0M	May be installed directly in the coils and drain pan, no additional space needed
10	Spray Humidifier		6M/8M	Could share the drift eliminator with cooling coil when it is installed next the coil.
11	Fan		Refer to fan table	Four discharge configurations available
12	Combined Mixing Chamber		(0608~0912) 10M (0913~1825) 12M (2025~2333) 18M (2435~2735) 24M	
13	Attenuator		6M (1 Level) 12M (2 Level)	Access section is recommended at upstream
14	Supply Chamber		(0608~0912) 5M (0913~1317) 6M (1418~1621) 8M (1822~2025) 9M (2125~2333) 11M (2435~2735) 12M	Supply damper may be installed in either a vertical or a horizontal position
15	Plenum/Access		≥1M	
16	High Efficiency Filter		≥8M	
17	Energy Recovery		6M/9M (Heat wheel)	Module of plate exchanger depends on unit model
18	Electrode Humidifier		6M	
19	Electrostatic Filter		4M	

## Standard components (2832~3438)

No.	Unit Section	Diagram	Section Length (M: Module)	Remark
1	Return/Mixing Chamber		(2832) 12M (3132~3438) 15M	
2	Single Filter (panel/bag)		3/4/5/6/8/9M	Access section is recommended at upstream
3	Combined Filter		3/4/5/6/8/9M	Access section is recommended at upstream
4	Cooling Coil		12M	
5	Heating Coil		3M	
6	Steam Heating Coil		3M	
7	Electric Heating Coil		3M	
8	Steam Humidifier		6M	
9	Fan		Refer to fan table	Four discharge configurations available
10	Combined Mixing Chamber		(2832) 26M (3132~3438) 32M	
11	Attenuator		6M (1 Level) 12M (2 Level)	Access section is recommended at upstream
12	Supply Chamber		(2832) 12M (3132~3438) 15M	Supply damper may be installed in either a vertical or a horizontal position
13	Plenum/Access		≥1M	
14	High Efficiency Filter		≥8M	

# 1/2" Coil connection (0608~2333)

## Cooling coil 0608~1825

Unit Size	A	B	F	D								E								ØC
				3R	4R	5R	6R	7R	8R	3R	4R	5R	6R	7R	8R					
0608	790	357	232	105	91	77	63	102	84	160	174	187	201	212	226	1-1/2" MPT				
0609	790	421	232	105	91	77	63	102	84	160	174	187	201	212	226	1-1/2" MPT				
0711	890	472	238	105	91	77	70	102	84	175	174	187	194	212	226	2" MPT				
0811	990	599	238	105	91	77	70	102	84	175	174	187	194	212	226	2" MPT				
0912	1090	648	246	105	91	77	77	102	84	187	174	187	187	212	226	2-1/2" MPT				
0913	1090	648	246	105	91	77	77	102	84	187	174	187	187	212	226	2-1/2" MPT				
0914	1090	648	246	105	91	77	77	102	84	187	174	187	187	212	226	2-1/2" MPT				
1015	1190	775	246	105	91	77	77	102	84	187	174	187	187	212	226	2-1/2" MPT				
1117	1290	824	253	84	84	84	84	102	84	180	181	180	180	212	226	3" MPT				
1317	1490	1078	253	84	84	84	84	102	84	180	181	180	180	212	226	3" MPT				
1418	1590	1142	253	84	84	84	84	102	84	180	181	180	180	212	226	3" MPT				
1420	1600	1142	253	84	84	84	84	102	84	180	181	180	180	212	226	3" MPT				
1621	1790	1332	253	84	84	84	84	102	84	180	181	180	180	212	226	3" MPT				
1822	1990	1586	253	84	84	84	84	102	84	180	181	180	180	212	226	3" MPT				
1825	1990	1586	253	84	84	84	84	102	84	180	181	180	180	212	226	3" MPT				

## Heating coil 0608~1825

Unit Size	A	F	D		B		E		ØC
			1R	2R	1R	2R	1R	2R	
0608	790	232	62	61.75	341	357	131	131	1-1/2" MPT
0609	790	232	62	61.75	405	421	131	131	
0711	890	232	62	61.75	468	484	131	131	
0811	990	232	62	61.75	595	611	131	131	
0912	1090	232	62	61.75	659	675	131	131	
0913	1090	232	62	61.75	659	675	131	131	
0914	1090	232	62	61.75	659	675	131	131	
1015	1190	232	62	61.75	786	802	131	131	
1117	1290	232	62	61.75	849	865	131	131	
1317	1490	232	62	61.75	1103	1119	131	131	
1418	1590	232	62	61.75	1167	1183	131	131	
1420	1600	232	62	61.75	1167	1183	131	131	
1621	1790	232	62	61.75	1357	1373	131	131	
1822	1990	232	62	61.75	1611	1627	131	131	
1825	1990	232	62	61.75	1611	1627	131	131	

Note: The data in table are just for your reference

## Cooling coil 2025~2735

机组型号	A	B	F	G	D				E				ØC
					3R/4R/6R	5R	7R	8R	3R/4R/6R	5R	7R	8R	
2025	2190	950	257	694	109	84	102	88	206	230	212	226	3" MPT
2125	2290	1077	257	694	109	84	102	88	206	230	212	226	3" MPT
2226	2390	1204	257	694	109	84	102	88	206	230	212	226	3" MPT
2328	2490	1268	257	694	109	84	102	88	206	230	212	226	3" MPT
2330	2490	1268	257	694	109	84	102	88	206	230	212	226	3" MPT
2333	2490	1268	257	694	109	84	102	88	206	230	212	226	3" MPT
2435	2590	1395	257	694	84	84	84	84	204	204	204	204	4" MPT
2635	2790	1586	257	694	84	84	84	84	204	204	204	204	4" MPT
2735	2890	1713	257	694	84	84	84	84	204	204	204	204	4" MPT

## Heating coil 2025~2735

机组型号	A	F	B		D		E		G		H		ØC
			1R	2R	1R	2R	1R	2R	1R	2R	1R	2R	
2025	2190	232	976	992	62	61.75	131	131	723	729	62	56	1-1/2" MPT
2125	2290	232	1103	1119	62	61.75	131	131	723	729	62	56	
2226	2390	232	1230	1246	62	61.75	131	131	723	729	62	56	
2328	2490	232	1294	1309.5	62	61.75	131	131	723	729	62	56	
2330	2490	232	1294	1309.5	62	61.75	131	131	723	729	62	56	
2333	2490	232	1294	1309.5	62	61.75	131	131	723	729	62	56	
2435	2590	232	1421	1437	62	61.75	131	131	723	729	62	56	
2635	2790	232	1612	1628	62	61.75	131	131	723	729	62	56	
2735	2890	232	1739	1755	62	61.75	131	131	723	729	62	56	

Note: The data in table are just for your reference

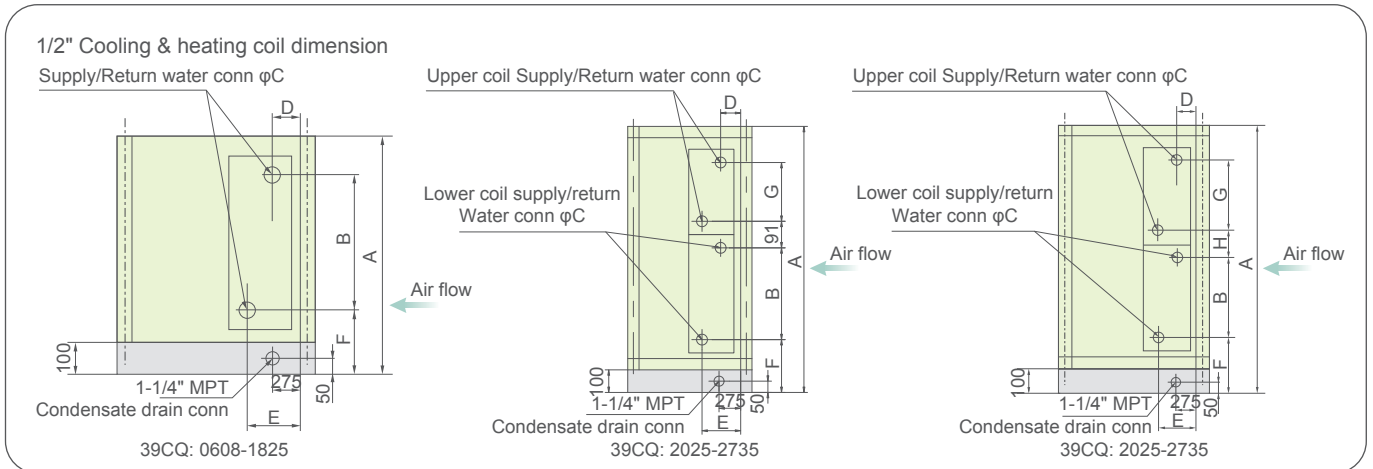

## 3/8" Coil connection (0608~1317)

3/8" Cooling & Heating coil dimension

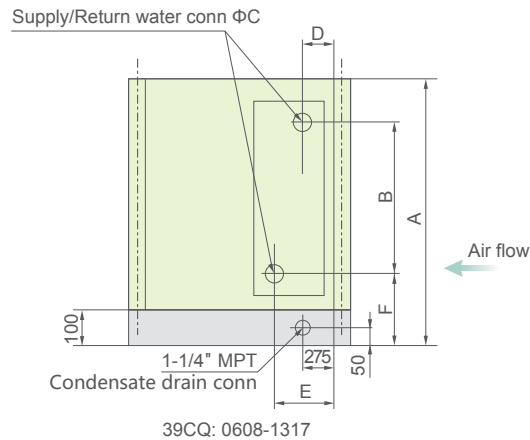

Cooling coil 0608~1317

Unti Size	A	F	B	D					E					ØC
				3R	4R/6R	5R	7R	8R	3R	4R/6R	5R	7R	8R	
0608	800	231	384	95	77	88	91	102	169	187	176	223	212	1-1/2" MPT
0609	800	231	435	95	77	88	91	102	169	187	176	223	212	1-1/2" MPT
0711	900	237	474	95	77	88	91	102	169	187	176	223	212	2" MPT
0811	1000	237	576	95	77	88	91	102	169	187	176	223	212	2" MPT
0912	1100	245	661	85	77	88	91	102	179	187	176	223	212	2-1/2" MPT
0913	1100	245	661	85	77	88	91	102	179	187	176	223	212	2-1/2" MPT
0914	1100	245	661	85	77	88	91	102	179	187	176	223	212	2-1/2" MPT
1015	1200	245	763	85	77	88	91	102	179	187	176	223	212	2-1/2" MPT
1117	1300	252	850	85	84	88	91	102	179	180	176	223	212	3" MPT
1317	1500	252	1054	85	84	88	91	102	179	180	176	223	212	3" MPT

Note: The data in table are just for your reference.

Heating coil 0608~1317

Unti Size	A	F	B		D	E	ØC
			1R	2R	1R/2R	1R/2R	
0608	800	231	372	385	62	131	1-1/2" MPT
0609	800	231	423	436	62	131	
0711	900	231	474	487	62	131	
0811	1000	231	575	588	62	131	
0912	1100	231	677	690	62	131	
0913	1100	231	677	690	62	131	
0914	1100	231	677	690	62	131	
1015	1200	231	778	791	62	131	
1117	1300	231	880	893	62	131	
1317	1500	231	1083	1096	62	131	

Note: The data in table are just for your reference.

## Cooling coil connection (2832~3438)

Unit Size	Total Qty of Coil	Coil Model*Qty	Coil Diameter*Qty
39CQ2832	2	5100*1	Ø89*2
		6100*1	6100 upper coil: Ø48*2
		6100*1	6100 Under coil: Ø89*2
39CQ3132	2	5100*1	Ø89*2
		7100*1	7100 upper coil: Ø48*2
		7100*1	7100 Under coil: Ø89*2
39CQ3438	4	760*2	760 upper coil: Ø48*4
		760*2	760 Under coil: Ø89*4
		660*2	660 upper coil: Ø48*4
		660*2	660 Under coil: Ø60*4

Note: The data in table are just for your reference  
Both sides water connection for unit 3438

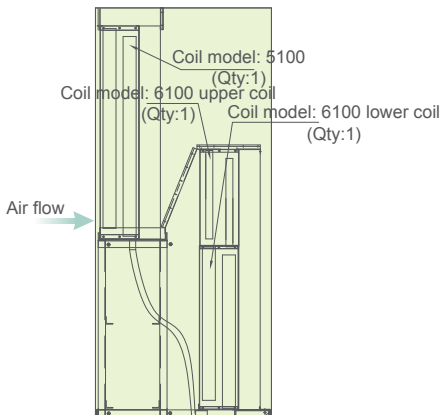

Figure 2: 39CQ 2832

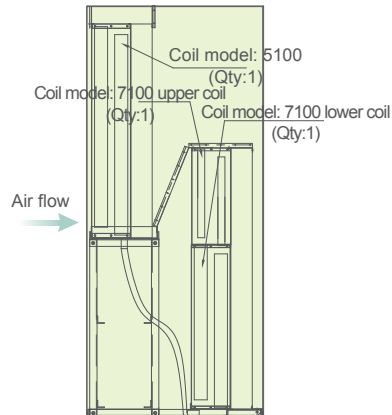

Figure 3: 39CQ 3132

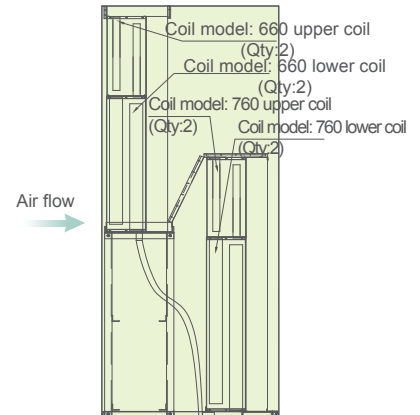

Figure 4: 39CQ 3438

## Heating coil connection (2832~3438)

Unit Size	Total Qty of Coil	Coil Model*Qty	Coil Diameter*Qty
39CQ2832	2	4100*1	Ø48*2
		5100*1	Ø48*2
39CQ3132	2	5100*2	Ø48*4
39CQ3438	6	360*2	Ø48*4
		460*4	Ø48*8

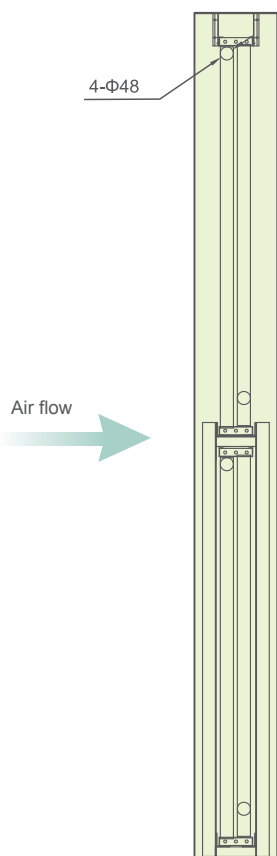

Figure 1: 39CQ 2832, 3132

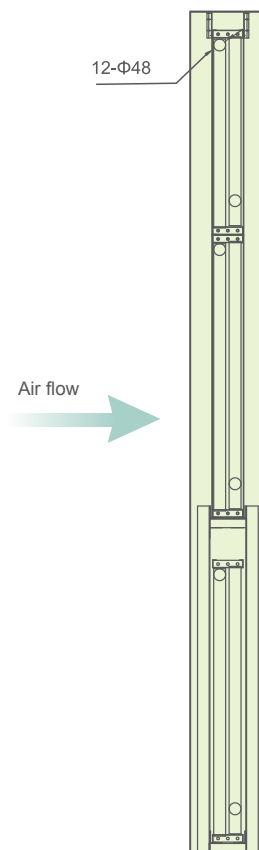
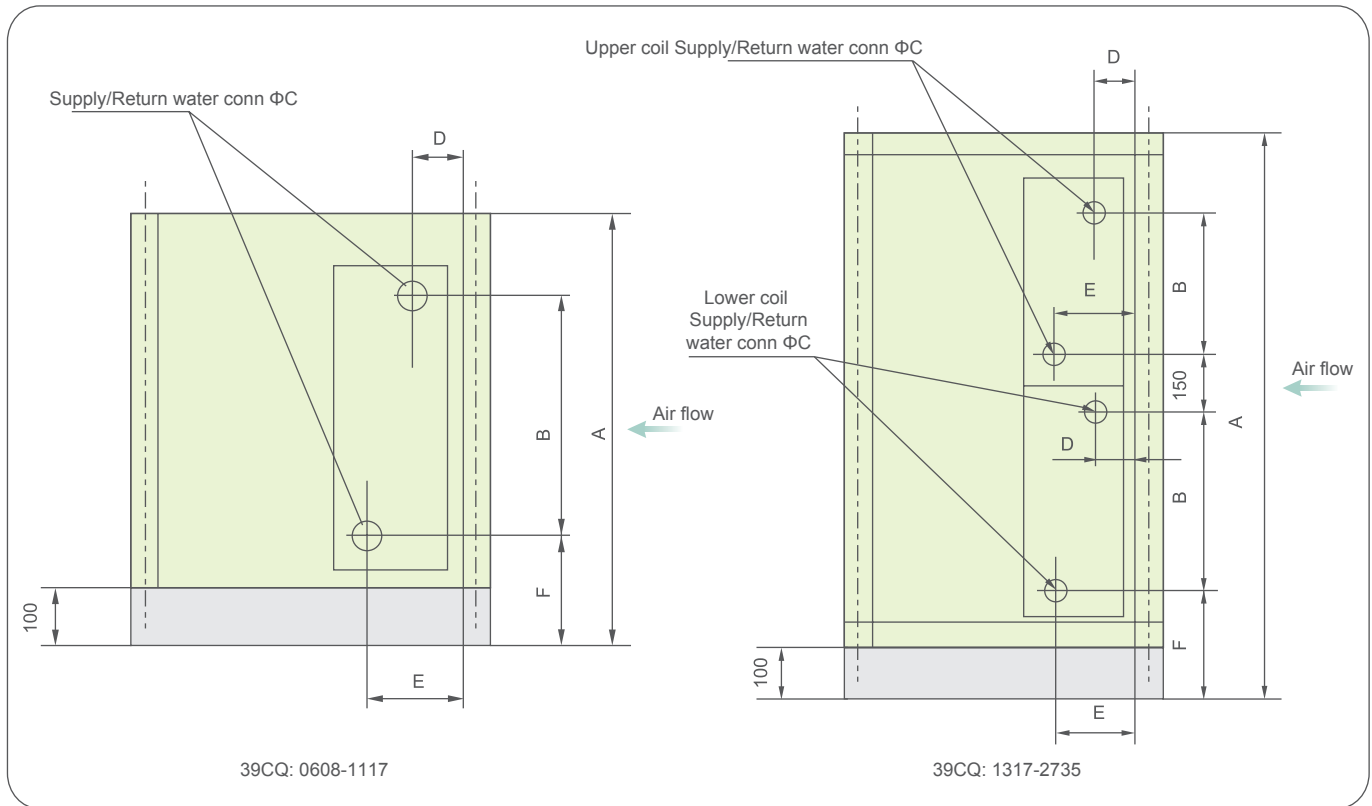

Figure 2: 39CQ 3438

Note: The data in table are just for your reference  
Both sides water connection for unit 3438

## Steam coil connection (0608~2735)



Unit Size	A	F	B	ØC	D	E
0608	790	243	347	2" MPT	80	150
0609	790	243	347	2" MPT	80	150
0711	890	243	418	2" MPT	80	150
0811	990	243	560	2" MPT	80	150
0912	1090	243	631	2" MPT	80	150
0913	1090	243	631	2" MPT	80	150
0914	1090	243	631	2" MPT	80	150
1015	1190	243	738	2" MPT	80	150
1117	1290	243	738	2" MPT	80	150

Note: The data in table are just for your reference.

Unit Size	A	F	B	ØC	D	E
1317	1490	243	489	2" MPT	80	150
1418	1590	243	520	2" MPT	80	150
1420	1590	243	520	2" MPT	80	150
1621	1790	243	631	2" MPT	80	150
1822	1990	243	738	2" MPT	80	150
1825	1990	243	738	2" MPT	80	150
2025	2190	243	844	2" MPT	80	150
2125	2290	243	844	2" MPT	80	150
2226	2390	243	844	2" MPT	80	150
2328	2490	243	884	2" MPT	80	150
2330	2490	243	884	2" MPT	80	150
2333	2490	243	884	2" MPT	80	150
2435	2590	243	924	2" MPT	80	150
2635	2790	243	1004	2" MPT	80	150
2735	2890	243	1084	2" MPT	80	150

Note: The data in table are just for your reference.

Connection dimensions of unit 2832 and above depend on the actual condition.

## Fan & Motor (0608~2735)

Unit Size	Fan Model	Max. Motor Power (kw)	Max.Motor Model
39CQ0608	FC160	1.5	Y90
	FC180		
39CQ0609	FC180	2.2	Y100
	FC200		
39CQ0711	FC200	3.7	Y112
	FC225		
39CQ0811	FC225	3.7	Y112
	FC/BC250		
39CQ0912	FC/BC250	5.5	Y132
	FC/BC280		
39CQ0913	FC/BC280	5.5	Y132
	FC/BC315		
39CQ0914	FC/BC315	7.5	Y132
	FC/BC355		
39CQ1015	FC/BC355	7.5	Y132
	FC/BC400		
39CQ1117	FC/BC400	11	Y160
	FC/BC450		
39CQ1317	FC/BC400	15	Y160
	FC/BC450		
39CQ1418	FC/BC450	15	Y160
	FC/BC500		
39CQ1420	FC/BC500	18.5	Y180
	FC/BC560		
39CQ1621	FC/BC560	18.5	Y180
	FC/BC630		
39CQ1822	FC/BC560	18.5	Y180
	FC/BC630		
39CQ1825	FC/BC630	30	Y200
	FC/BC710		
39CQ2025	FC/BC630	30	Y200
	FC/BC710		
39CQ2125	FC/BC710	30	Y200
	FC/BC800		
39CQ2226	FC/BC710	30	Y200
	FC/BC800		
39CQ2328	FC/BC800	37	Y225
	FC/BC900		
39CQ2330	FC/BC800	37	Y225
	FC/BC900		
39CQ2333	FC/BC800	45	Y225
	FC/BC900		
39CQ2435	FC/BC900	55	Y250
	FC/BC1000		
39CQ2635	FC/BC900	55	Y250
	FC/BC1000		
39CQ2735	FC/BC900	75	Y280
	FC/BC1000		

Note: Please refer to selection software for detailed fan section parameter.



## Fan arrangement-horizontal unit

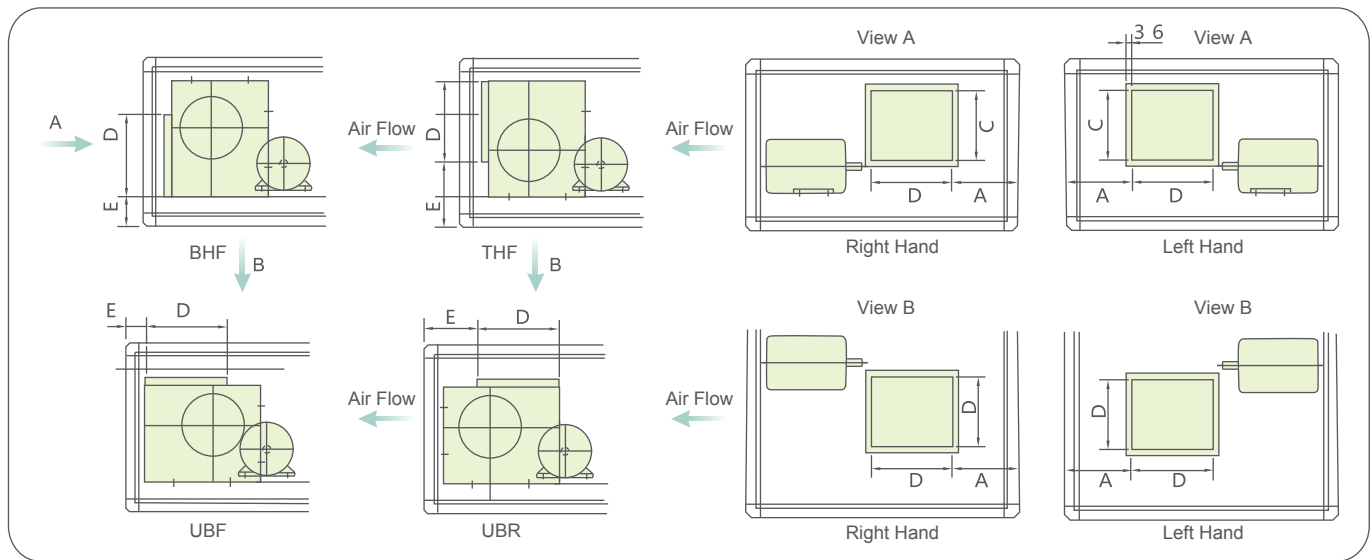

(mm)

Unit Size	Fan Model	A	D	E			
				THF	BHF	UBF	UBR
39CQ0608	FC160	224.0	205.0	285.5	163.0	224.0	192.0
	FC180	179.5	229.0	285.5	163.0	188.0	217.0
39CQ0609	FC180	291.0	229.0	285.5	163.0	188.0	217.0
	FC200	260.5	256.0	293.5	163.0	187.0	226.0
39CQ0711	FC200	360.5	256.0	293.5	163.0	187.0	226.0
	FC225	311.5	288.0	307.5	163.0	201.0	263.0
39CQ0811	FC225	311.5	288.0	307.5	163.0	201.0	263.0
	FC/BC250	311.5	322.0	319.0	163.0	176.0	252.0
39CQ0912	FC/BC250	361.5	322.0	319.0	163.0	176.0	252.0
	FC/BC280	335.5	361.0	336.0	163.0	175.0	301.0
39CQ0913	FC/BC280	385.5	361.0	336.0	163.0	175.0	301.0
	FC/BC315	342.5	404.0	355.0	163.0	170.0	288.0
39CQ0914	FC/BC315	392.5	404.0	355.0	163.0	170.0	288.0
	FC/BC355	395.5	453.0	380.0	188.0	170.0	310.0
39CQ1015	FC/BC355	445.5	453.0	380.0	188.0	170.0	310.0
	FC/BC400	394.5	507.0	408.0	188.0	170.0	340.0
39CQ1117	FC/BC400	494.5	507.0	408.0	188.0	170.0	340.0
	FC/BC450	434.5	569.0	437.0	188.0	170.0	368.0
39CQ1317	FC/BC400	494.5	507.0	408.0	188.0	170.0	340.0
	FC/BC450	389.5	569.0	437.0	188.0	170.0	368.0
39CQ1418	FC/BC450	439.5	569.0	437.0	188.0	170.0	368.0
	FC/BC500	420.5	638.0	458.0	188.0	170.0	390.0
39CQ1420	FC/BC500	520.5	638.0	458.0	188.0	170.0	390.0
	FC/BC560	511.5	715.0	549.0	248.0	170.0	421.0
39CQ1621	FC/BC560	511.5	715.0	549.0	248.0	170.0	421.0
	FC/BC630	425.5	801.0	591.0	248.0	170.0	464.0
39CQ1822	FC/BC560	611.5	715.0	549.0	248.0	170.0	421.0
	FC/BC630	525.5	801.0	591.0	248.0	170.0	464.0
39CQ1825	FC/BC630	720.5	801.0	591.0	248.0	170.0	464.0
	FC/BC710	623.5	898.0	639.0	248.0	170.0	511.0
39CQ2025	FC/BC630	720.5	801.0	591.0	248.0	170.0	464.0
	FC/BC710	623.5	898.0	639.0	248.0	170.0	511.0
39CQ2125	FC/BC710	573.5	898.0	639.0	248.0	170.0	511.0
	FC/BC800	513.5	1007.0	708.0	261.0	170.0	567.0
39CQ2226	FC/BC710	673.5	898.0	639.0	248.0	170.0	511.0
	FC/BC800	613.5	1007.0	708.0	261.0	170.0	567.0
39CQ2328	FC/BC800	663.5	1007.0	708.0	261.0	170.0	567.0
	FC/BC900	635.5	1130.0	765.0	261.0	170.0	624.0
39CQ2330	FC/BC800	815.0	1007.0	708.0	261.0	170.0	567.0
	FC/BC900	787.0	1130.0	765.0	261.0	170.0	624.0
39CQ2333	FC/BC800	963.5	1007.0	708.0	261.0	170.0	567.0
	FC/BC900	935.5	1130.0	765.0	261.0	170.0	624.0
39CQ2435	FC/BC900	1135.5	1130.0	765.0	261.0	170.0	624.0
	FC/BC1000	1035.5	1267.0	833.0	310.0	170.0	643.0
39CQ2635	FC/BC900	1135.5	1130.0	765.0	261.0	170.0	624.0
	FC/BC1000	1035.5	1267.0	833.0	310.0	170.0	643.0
39CQ2735	FC/BC900	1035.5	1130.0	765.0	261.0	170.0	624.0
	FC/BC1000	935.5	1267.0	833.0	310.0	170.0	643.0

Note: The length mentioned is internal dimensions of fan section.

## Fan arrangement-vertical unit

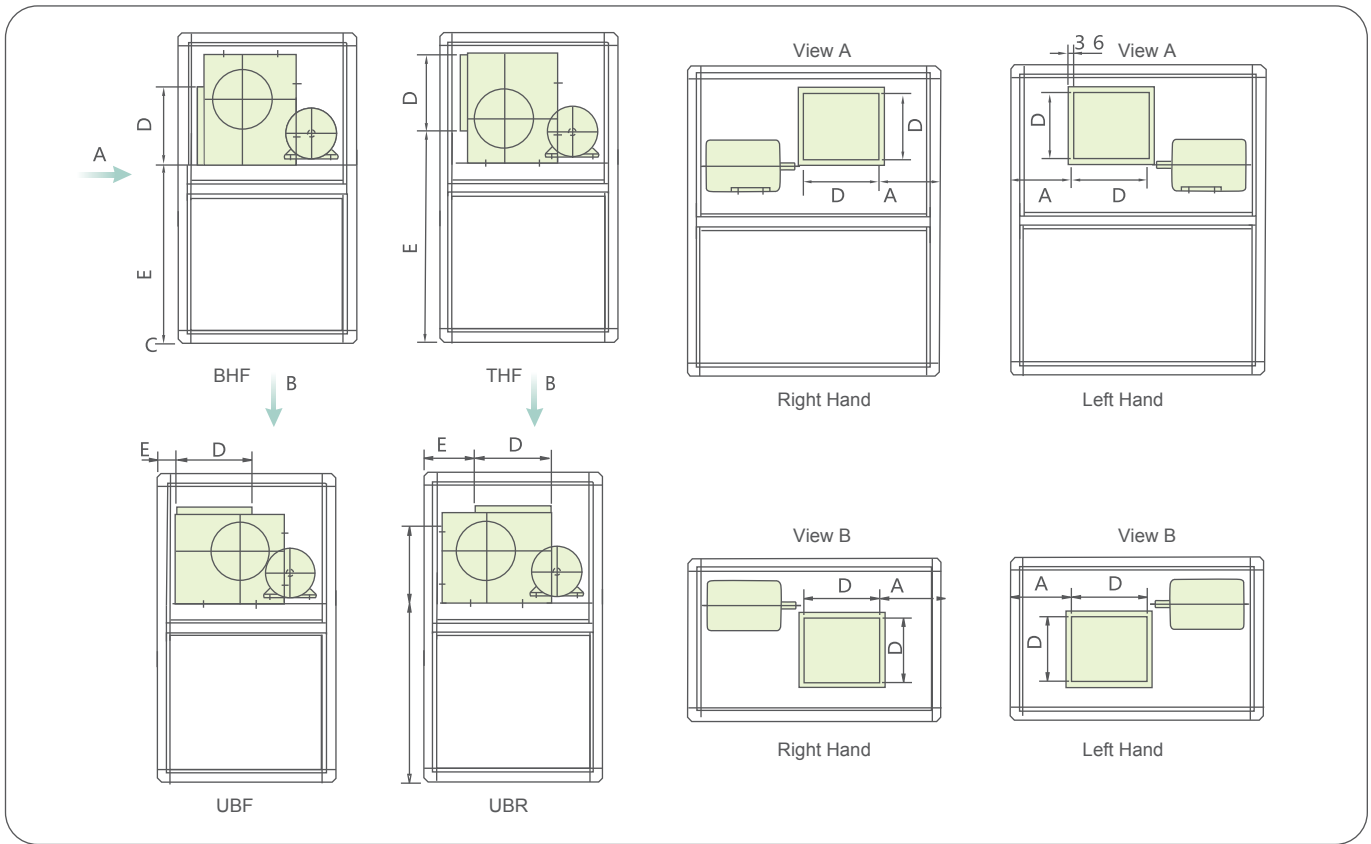

(mm)

Unit Size	Fan Model	A	D	E			
				THF	BHF	UBF	UBR
39CQ0608	FC160	224.0	205	985.5	863.0	170	192
	FC180	179.5	229	985.5	863.0	170	217
39CQ0609	FC180	291.0	229	985.5	863.0	170	217
	FC200	260.5	256	993.5	863.0	170	226
39CQ0711	FC200	360.5	256	1093.5	963.0	170	226
	FC225	311.5	288	1107.5	963.0	170	263
39CQ0811	FC225	311.5	288	1207.5	1063.0	170	263
	FC/BC250	311.5	322	1219.0	1063.0	170	252
39CQ0912	FC/BC250	361.5	322	1319.0	1163.0	170	252
	FC/BC280	335.5	361	1336.0	1163.0	170	301
39CQ0913	FC/BC280	385.5	361	1336.0	1163.0	170	301
	FC/BC315	342.5	404	1355.0	1163.0	170	288
39CQ0914	FC/BC315	392.5	404	1355.0	1163.0	170	288
	FC/BC355	395.5	453	1380.0	1188.0	170	310
39CQ1015	FC/BC355	445.5	453	1480.0	1288.0	170	310
	FC/BC400	394.5	507	1508.0	1288.0	170	340
39CQ1117	FC/BC400	494.5	507	1608.0	1388.0	170	340
	FC/BC450	434.5	569	1637.0	1388.0	170	368
39CQ1317	FC/BC400	494.5	507	1808.0	1588.0	170	340
	FC/BC450	389.5	569	1837.0	1588.0	170	368
39CQ1418	FC/BC450	439.5	569	1937.0	1688.0	170	368
	FC/BC500	420.5	638	1958.0	1688.0	170	390
39CQ1420	FC/BC500	520.5	638	1958.0	1688.0	170	390
	FC/BC560	511.5	715	2049.0	1748.0	170	421
39CQ1621	FC/BC560	511.5	715	2249.0	1948.0	170	421
	FC/BC630	425.5	801	2291.0	1948.0	170	464

Note: The data in table are just for your reference.

## Fan arrangement-horizontal unit (2832~3438)

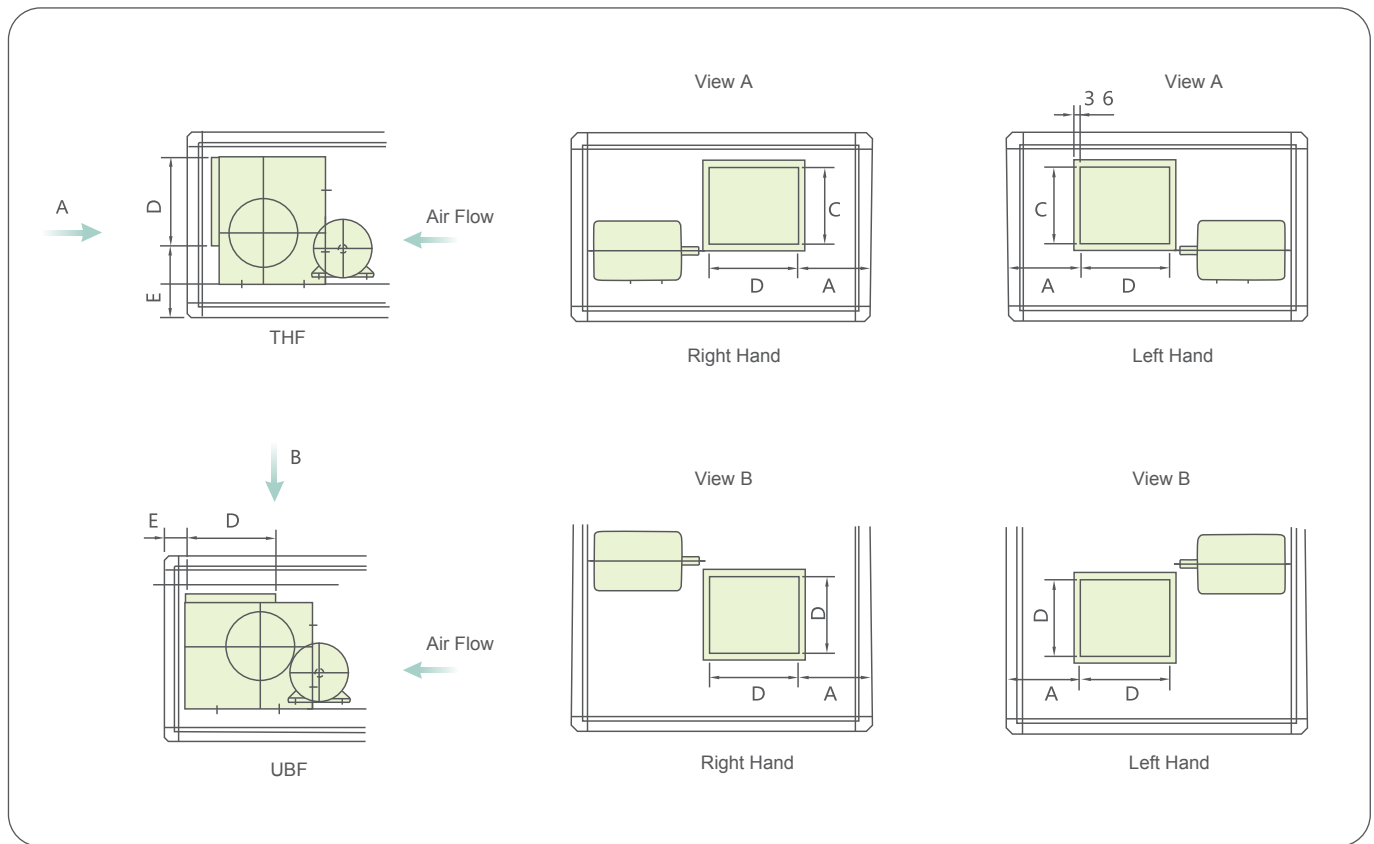

(mm)

Unit Size	Fan Model	A	D	E	
				THF	UBF
39CQ2832	BC1000	783.5	1267	867.5	190
	BC1120	556	1422	978	195
39CQ3132	BC1000	783.5	1267	867.5	190
	BC1120	556	1422	978	195
39CQ3438	BC1250	1038	1524	1147	99

Note: The data in table are just for your reference.

## Fan & Motor (2832~3438)

Unit Size	Fan Model	Max. Motor Power (kW)	Max. Motor Model
39CQ2832	BC1000	55	Y280
	BC1120	90	Y250
39CQ3132	BC1000	55	Y280
	BC1120	90	Y280
39CQ3438	BC1250	90	Y280

Note: Please refer to selection software for fan section length.

## Ordering Information

1. Unit Direction: Along the airflow direction, left unit refers to units with water inlet and outlet of the coils and the access door on the left side, vice versa.
2. If units installed at outdoors or in corrosive environment, shall consult factory before ordering so as to ensure unit meet with application requirements.
3. Requirements of the unit basement: The length and width of the unit basement should be designed according to the unit, and the basement should be horizontally flat and higher than the ground for ease of installation of the condensate trap.

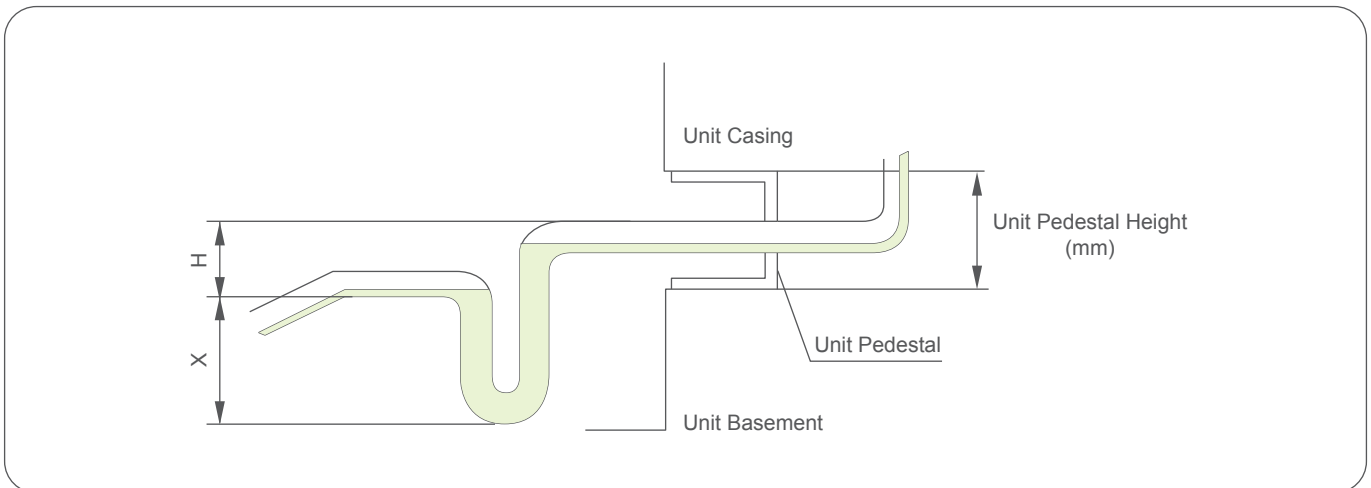

- Calculated Value:  $H = \text{Negative pressure at the drain hole of the condensate plate Pa} / 10(\text{mm})$ ,  $X > 1/2H$

- Empirical Value: when negative pressure  $< 1,000 \text{ Pa}$ ,  $H = 100\text{mm}$ ,  $X = 70\text{mm}$

4. Notice when connecting the coil: The designed working pressure of both cooling and heating coil is  $1.6\text{mPa}$ .
5. For fresh air units, when the temperature drops below  $2^\circ\text{C}$ , preheating devices should be required to prevent frost cracking of the coils inside the units.
6. The supply air temperature of the unit should not be higher than  $80^\circ\text{C}$  (when heating), requests as such shall be brought forward when ordering, so that high temperature bearings and motors could be adopted.
7. The unit outlet and duct should be connected with flexible connection.
8. Residual water should be drained of the coil if the temperature falls below the freezing point when the unit is shut down. Put antifreeze in the coil in case there's still residual water.
9. For electric heating,
  - 1) Electrical components and cable configuration shall be wires according to the power of electric heater.
  - 2) Wiring shall be carried out in line with the electric heater wiring diagram.
  - 3) The temperature relay signal of the electric heater shall be sent to the electric heating controller, to assure automatic power off when the temperature is too high in the unit.
  - 4) The controller of electric heater shall interlock control fan and electric heater, to keep the electric heater module powered off when the fan stops.
10. PTC thermistor has been installed in fan motor, should connected with protective relay, to achieve motor overheating protection function. If customer need more information about how to choose protective relay, please contact THC for technical support.



Carrier improves the world around us; Carrier improves people's lives; our products and services improve building performance; our culture of improvement will not allow us to rest when it comes to the environment.



[www.carrier.com](http://www.carrier.com)

The Manufacturer reserves the right to change any product specifications without prior notices  
© All Rights Reserved Carrier

Version:	CAT_39CQ_E-202002_03
Supersede:	CAT_39CQ_E-1510-02
Effective Date:	Feb, 2020