

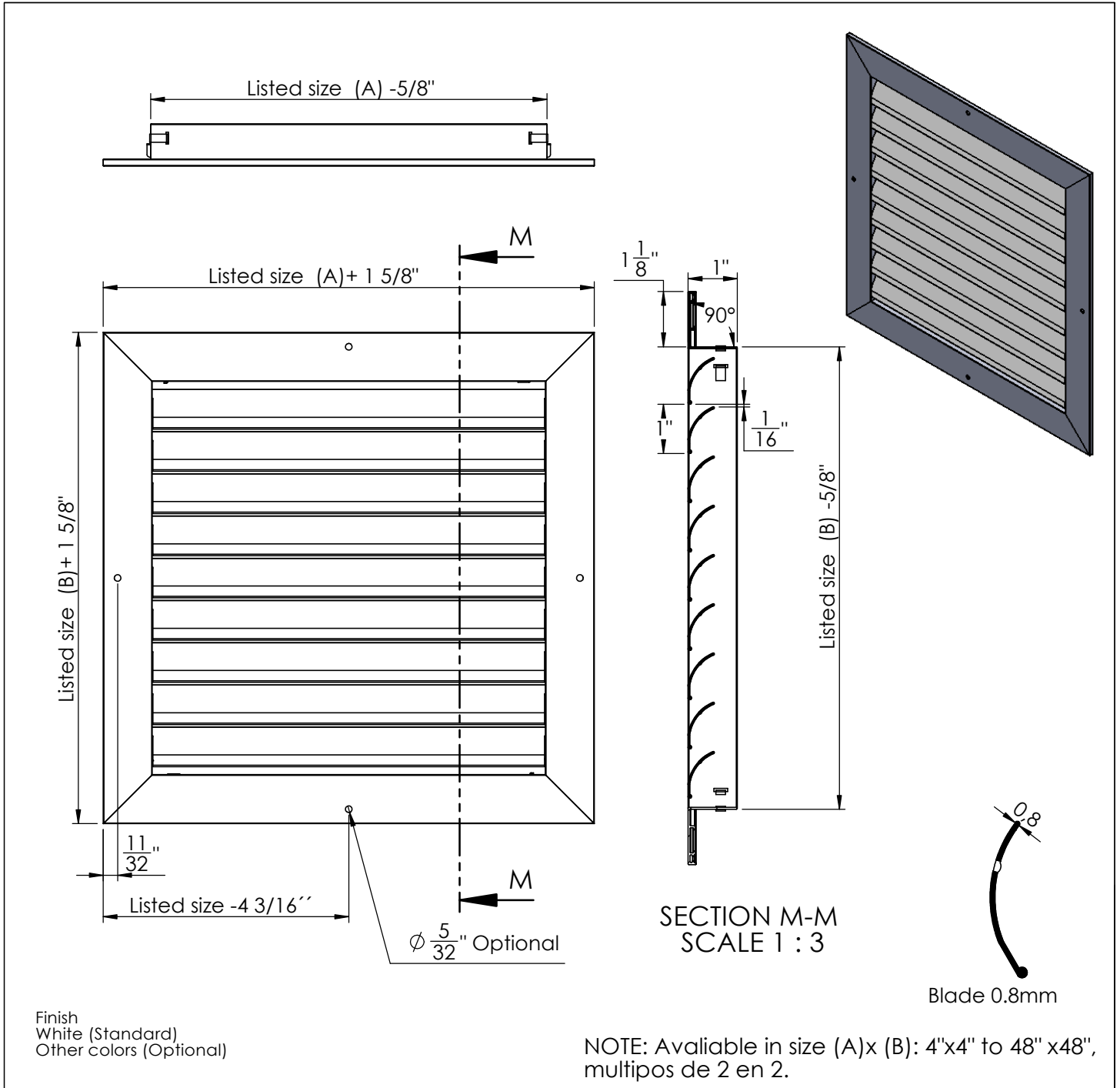

MODEL L-RA



MODEL L-RA

Extruded Aluminum

Job Name: _____

Architect: _____

Location: _____

Engineer: _____

Contractor: _____



MODEL L-RA-

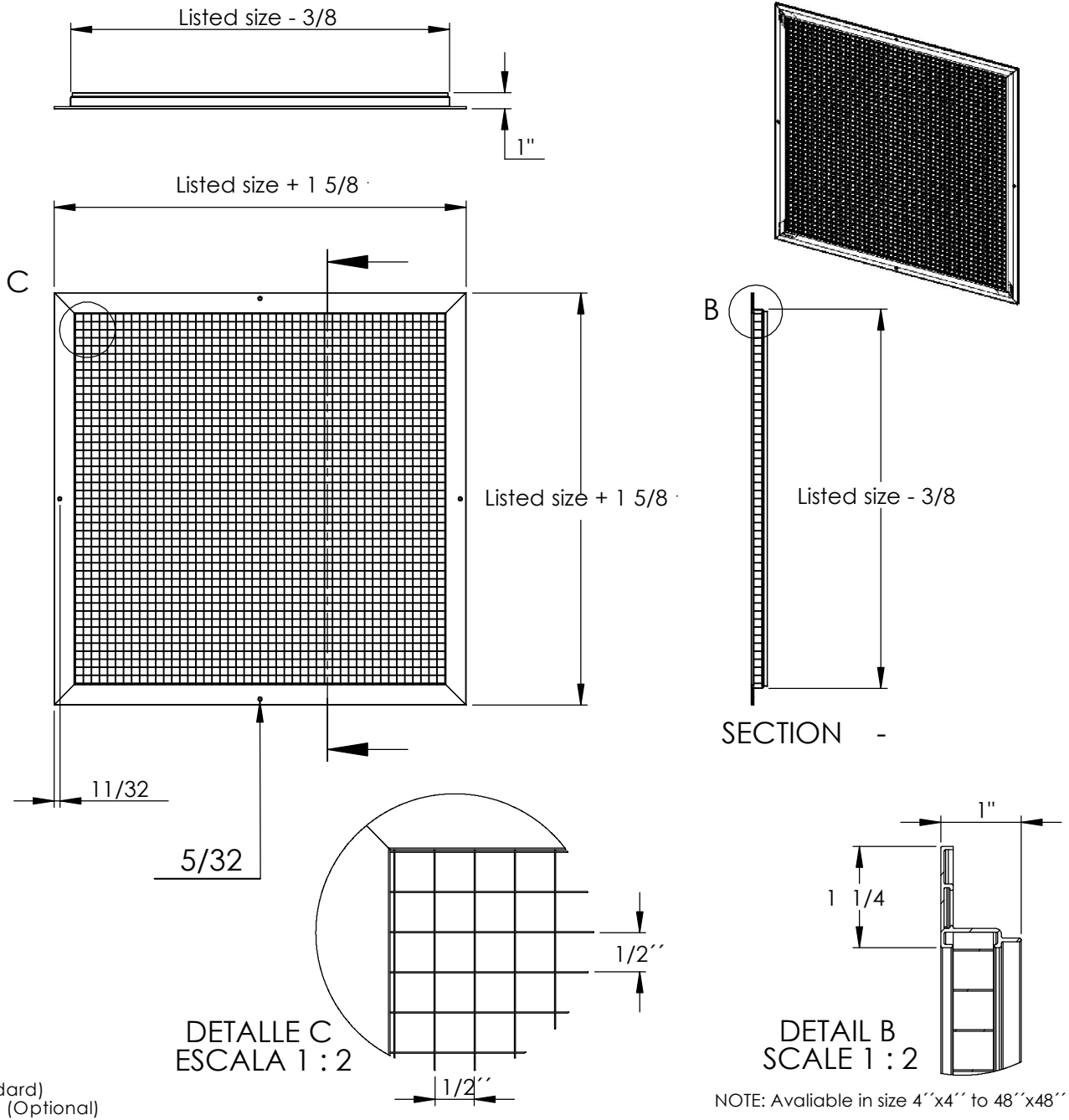

Finish
White (Standard)
Other colors (Optional)

NOTE: Available in size 4"x4" to 48"x48"

Dimensions are in inches

MODEL L-RA-

Extruded Aluminum

Job Name: _____
Location: _____

Architect: _____
Engineer: _____
Contractor: _____



MODEL L-RA-LP-A

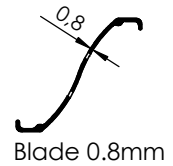
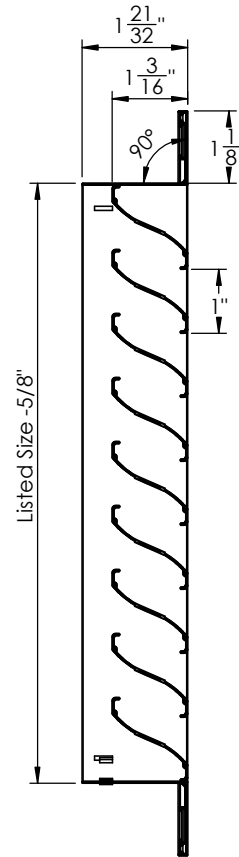
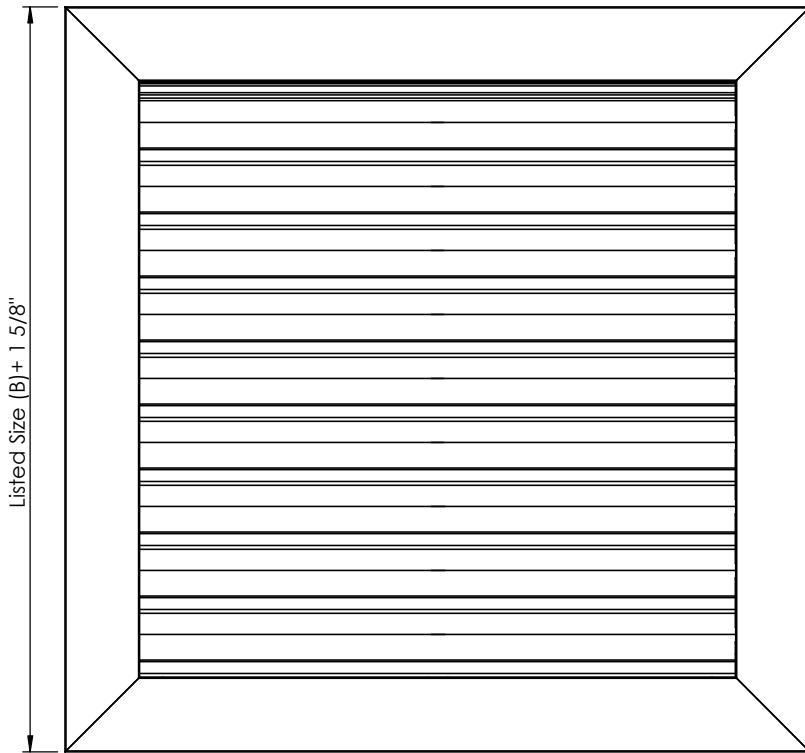
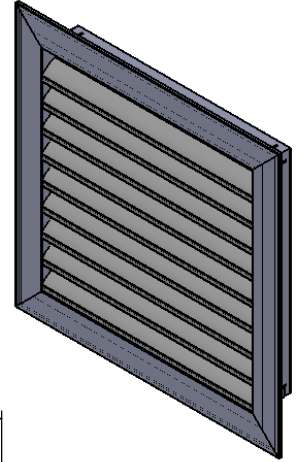
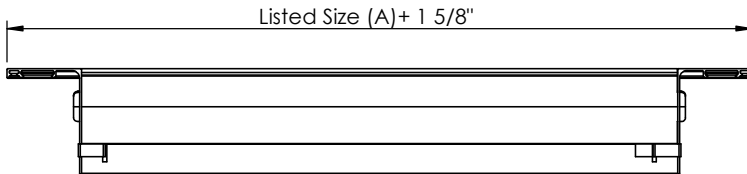

Finish
 White (Standard)
 Other colors (Optional)

NOTE: Available in size(A) from 8" to 72"
 (B) from 8" to 48"
 multiples de 2 en 2.

MODEL L-RA-LP-A

Extrude Aluminum

Job Name: _____
 Location: _____

Architect: _____
 Engineer: _____
 Contractor: _____



MODEL L-RA-LP-B

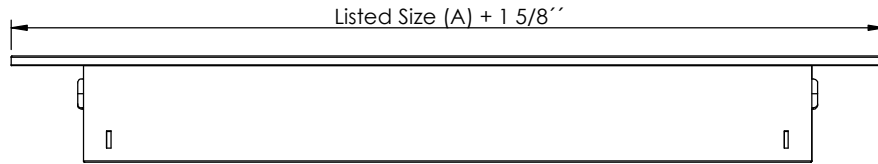
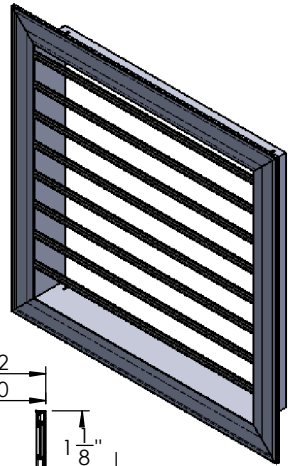

A

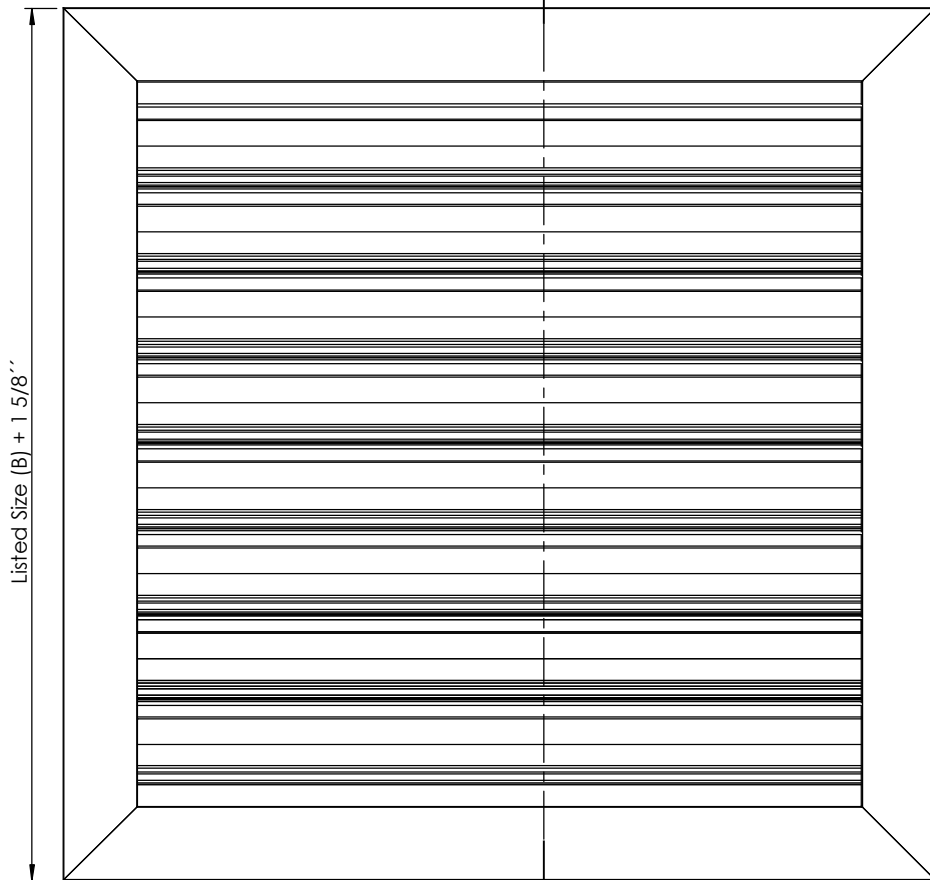

Finish
White (Standard)
Other colors (Optional)

A

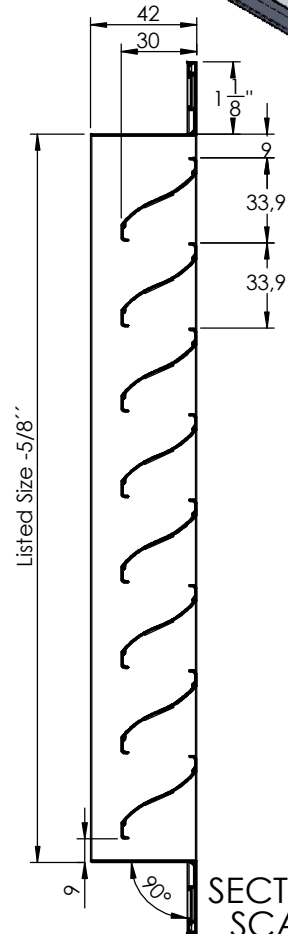

SECTION A-A
SCALE 1 : 3

NOTE: Available in size (A) from 8'' to 72'' multiples of 2
(B) from 8'' to 48'' multiples of 4

MODEL L-RA-LP-B

Extrude Aluminum

Job Name: _____

Architect: _____

Location: _____

Engineer: _____

Contractor: _____



MODEL L-RA-LP-C

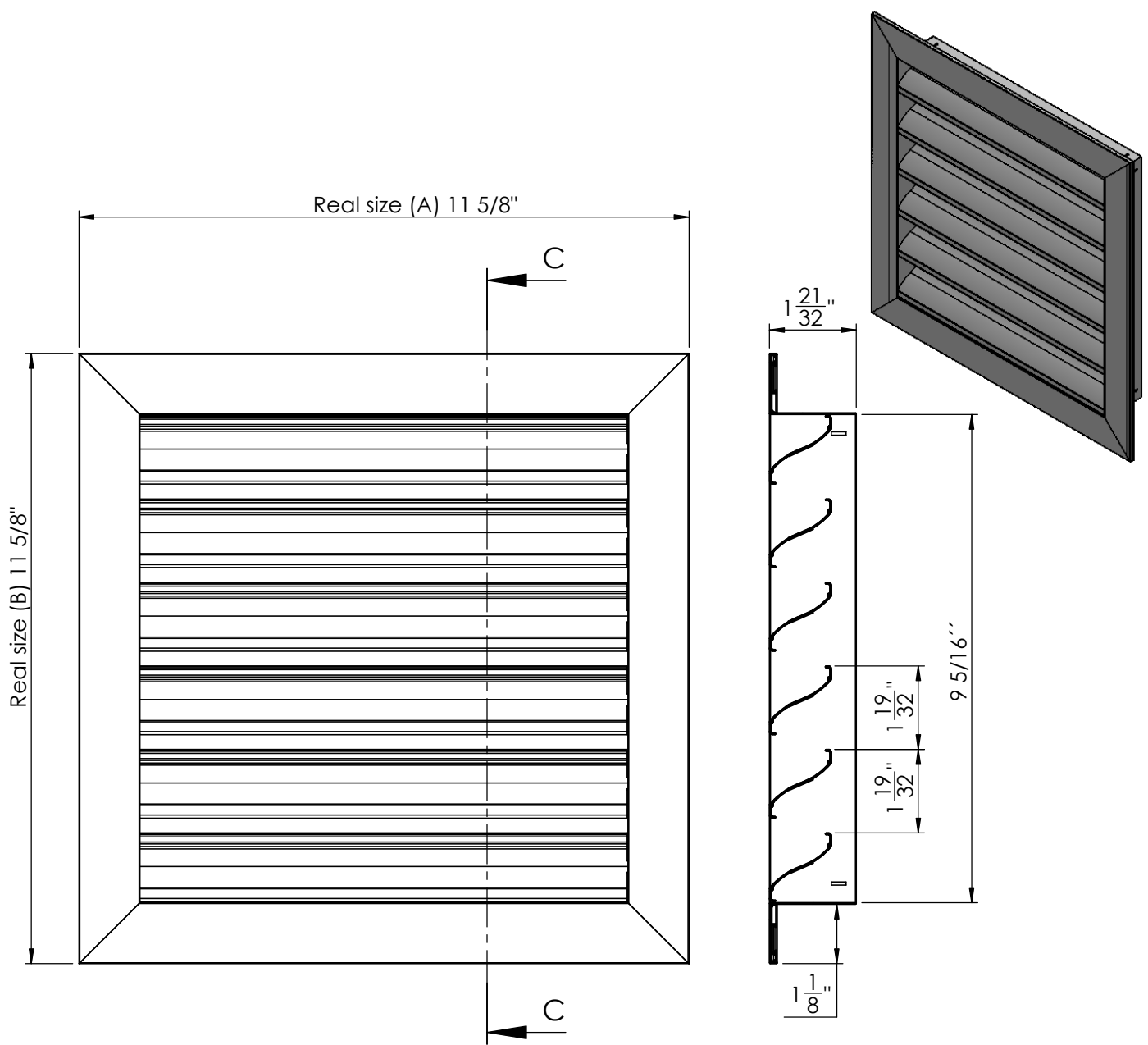

SECTION C-C
SCALE 1 : 3

Finish
White (Standard)
Other colors (Optional)

MODEL L-RA-LP-C

Extrude Aluminum

Job Name: _____
Location: _____

Architect: _____
Engineer: _____
Contractor: _____



MODEL L-RA-LP-V

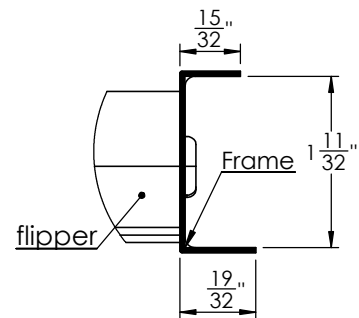
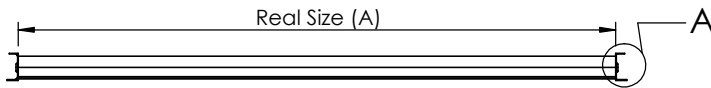
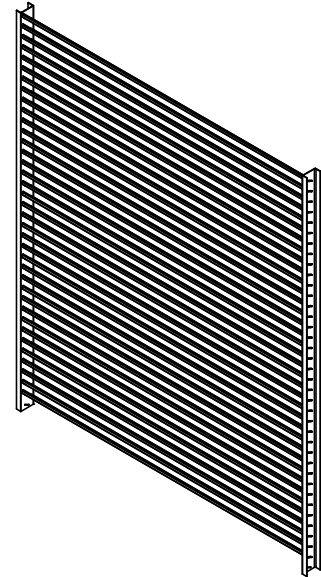
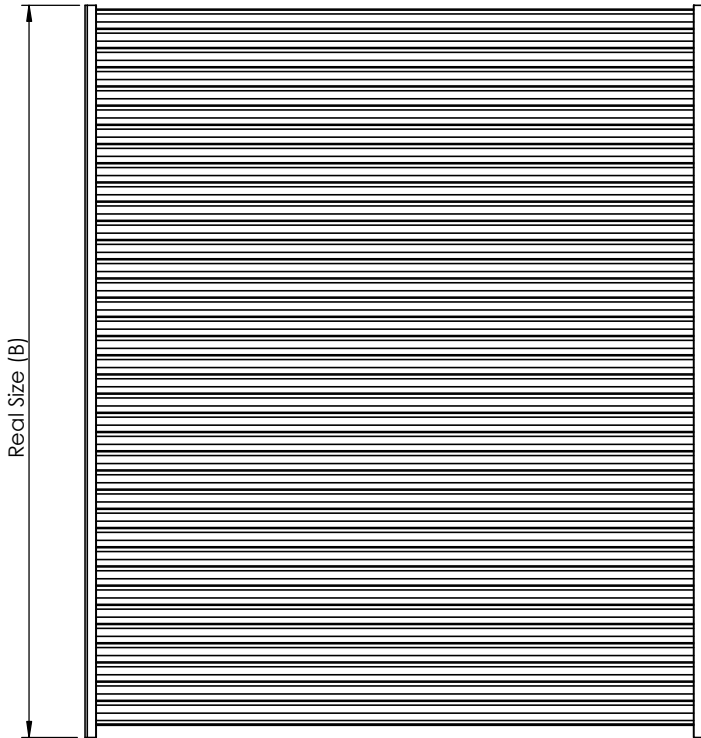

DETAIL A
SCALE 1 : 1.5

Finish
White (Standard)
Other colors (Optional)

NOTE: Available in real size(A) from 4'' to 28''
(B) from 6'' to 95''

MODEL L-RA-PL-V

Extrude Aluminum

Job Name: _____

Architect: _____

Location: _____

Engineer: _____

Contractor: _____



MODEL L-RA-P

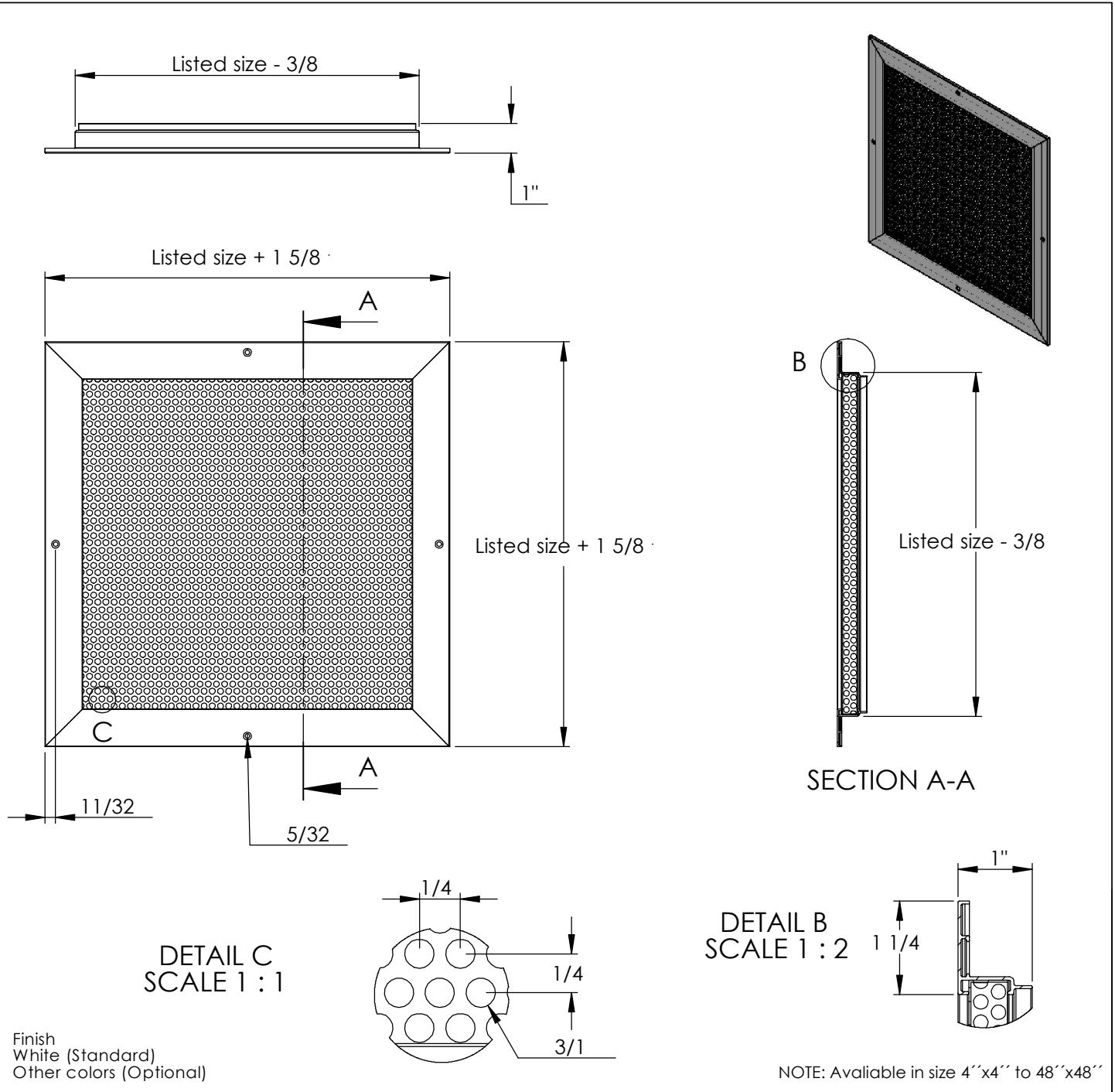

NOTE: Available in size 4"x4" to 48"x48"

Dimensions are in inches

MODEL L-RA-P

Extruded Aluminum Frame
Perforated Steel Sheet

Job Name: _____	Architect: _____
Location: _____	Engineer: _____
	Contractor: _____