



Facebook:  
@MASTOtechclean



Instagram:  
mastotech





**BE MORE EFFICIENT**

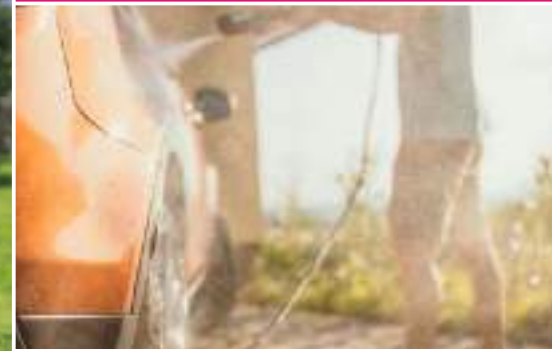



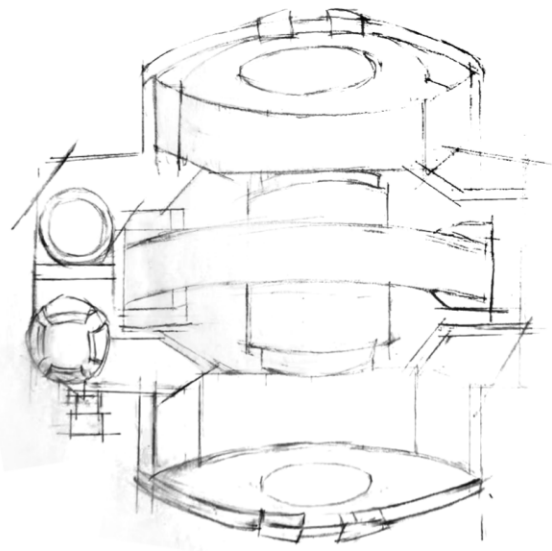

AC CLEANING MACHINE



CLEANING  
SPRAY GUN

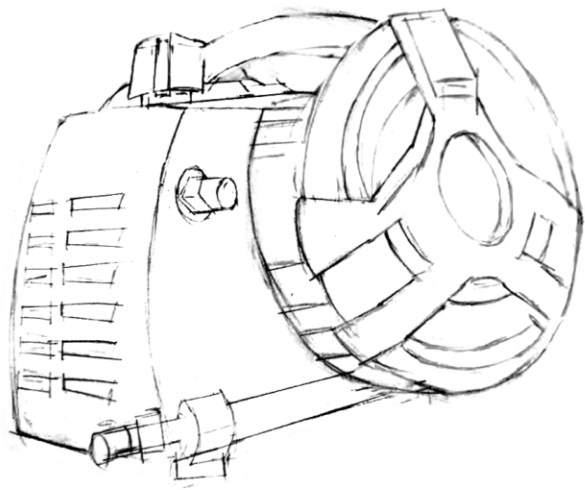

ONE MACHINE DUAL PURPOSES  
HIGH EFFICIENT CLEANING



## MASTO DESIGN

No matter how the times change, MASTO, with the ultimate ingenuity, condenses every beautiful idea, and makes the craftsmanship to the extreme. Feeling every detail, devoting a constant ingenuity to the product's meticulous care.

## ABOUT MASTO

MASTO has been committed to providing a series of professional and efficient cleaning equipment. MASTO, a customer-oriented company, fully understands the challenges you faced.

Visit us at [www.mastotech.com](http://www.mastotech.com)

We focus on household cleaning, commercial equipment cleaning, and large industrial equipment cleaning and maintenance. Our products also provide cleaning and disinfection support for social and public places in the era of the epidemic. We are determined to continuously innovate products to enhance users' experience and apply them to more fields in the future.



## CORDLESS CLEANING MACHINE SERIES

- M10L** Cordless Outdoor Leisure Cleaner
- M16L** Cordless Coil Cleaner

M10L/M16L is a kind of cordless cleaning equipment that can save time and effort of cleaning and meet the needs of more places cleaning, such as in residential, commercial, and industrial scenarios.





# Cordless Outdoor Leisure Cleaner

## M10L



### Product Overview

M10L's unique dual-use mode of AC and DC, not only can be powered by lithium batteries, but also can charge through the power supply. It has its own clean water tank and chemical tank, solving the problem of no water and power supply. It is easy to move on the ground, and the integrated back strap design can completely free your hands, so that you can enjoy cleaning at anytime and anywhere.

Different from the traditional high-pressure cleaning machine and low-pressure sprayer, our product provides two kinds of cleaning pressures, so we can select different cleaning pressure according to different occasions.

Our product can meet the needs of a variety of cleaning situations, such as yard cleaning, cleaning after outdoor activities, pet cleaning, glass cleaning, bicycle cleaning, etc.

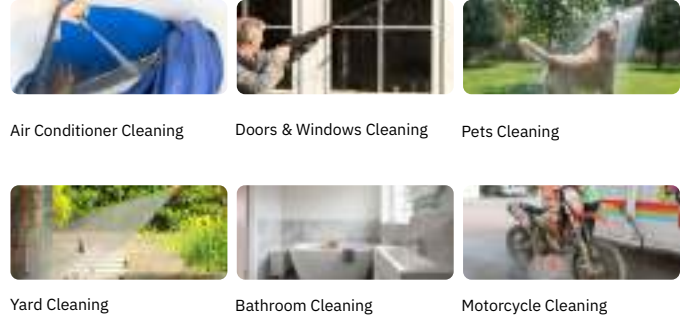

-  Lithium Battery Powered  
Ac Power Supply
-  Multipurpose Use
-  Excellent Mobility

### Technical Data

<b>Voltage:</b> 18V(AEG/RIDGID Interface)	<b>Pressure:</b> 5/10bar(72/145psi)
<b>Flow Rate:</b> 4L/min	<b>Tank Capacity:</b> 18L(water)+2L(chemical)
<b>Rated Power:</b> 80W	<b>Dimensions:</b> 568(h)*412(w)*282(h)
<b>Reference running time:</b> 50-120mins(4.0AhLi-ion battery)	
<b>Reference charging time:</b> 210mins(4.0AhLi-ion battery)	

**Remarks:** Due to the strict transportation terms, we can not include any Li-ion battery, you can choose our battery adapters for use your local batteries

### Accessories



### Dual Power Choice Battery Powered/AC Powered

It has ac / dc dual-mode. 18v lithium battery power can provide cordless cleaning, which is portable and convenient. AC power supply can provided corded cleaning with no time limited.

### Unique 1:3 Ratio Foaming Set

Unique spontaneous foam mixing valve for 1:3 mixing. The chemical and water are mixed in the ratio of 1:3, Which saves time and effort.

### Meet Multiple Scenarios Usage

Special design for these low pressure cleaning demand, Such as garden leisure, garden plants, outdoor balcony, Bicycle / motorcycle,etc. Ideal for hvac technician, it can quickly cleaning evaporator coils and condenser coil in locations where water and power may be inaccessible.



# Cordless Coil Cleaner M16L



- Cordless Cleaning**  
 18V lithium battery powered with a 18L clean water tank and 2L chemical tank, Easy to clean anytime, anywhere
- Powerful Pressure**  
 Up to 16bar(232psi) pressure can clean thicker, dirtier coils efficient without damaging sensitive fins.
- Professional Design**  
 1:3 ratio foaming valve, foaming nozzle, 220° rotational nozzle and 37cm extension rod to get the professional using experience.

# Cordless Coil Cleaner M16L



- Integrated Storage Design
- Portable & Mobile
- Suitcase Appearance
- Integrated Storage Tank

## Product Overview

M16L is a kind of cordless portable Air conditioner coil cleaning machine. It is powered by lithium battery and equipped with clean water tank and chemical tank, which solves the problem of no water source and power supply. It is easy to move on the ground, and the integrated back strap design can completely free your hands, so that you can enjoy cleaning at anytime and anywhere.

At the same time, it can do the cleaning under 16bar (232psi) pressure, which is different from traditional high-pressure cleaning machine and low-pressure sprayers, providing a double section pressure of 8bar and 16bar to efficiently clean the coil without damaging the sensitive fins.

In addition to the conventional outdoor cleaning in the courtyard, it is also especially suitable for the cleaning of internal air conditioners, external air conditioners, refrigeration evaporators, condenser coils, solar panels, etc.

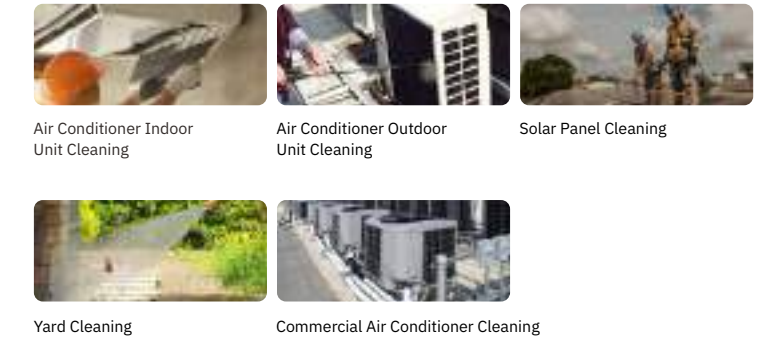

## Technical Data

<b>Voltage:</b> 18V(AEG/RIDGID Interface)	<b>Pressure:</b> 8/16bar(116/232psi)
<b>Flow Rate:</b> 4L/min	<b>Tank Capacity:</b> 18L(water)+2L(chemical)
<b>Rated Power:</b> 80W	<b>Dimensions:</b> 568(h)*412(w)*282(h)
<b>Reference running time:</b> 15-60mins(4.0AhLi-ion battery)	
<b>Reference charging time:</b> 210mins(4.0AhLi-ion battery)	
<b>Remarks:</b> Due to the strict transportation terms, we can not include any Li-ion battery, you can choose our battery adapters for use your local batteries	

## Accessories

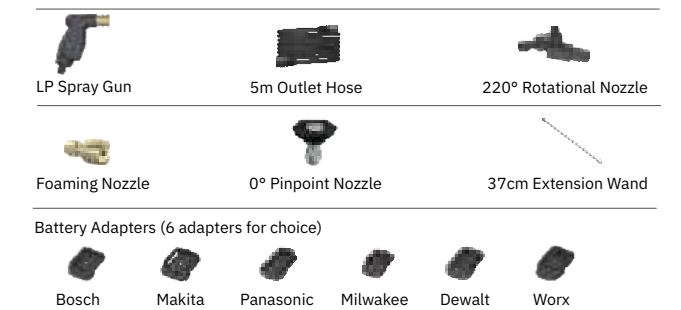





**M40**  
Adjustable High  
Pressure Cleaner



# Adjustable High Pressure Cleaner

## M40



Integrated Storage

Pressure Adjust Knob

Overhead Pressure Gauge

### Product Overview

The M40 is a comprehensive cleaning machine that differs from conventional high-pressure cleaning machine and low-pressure sprayers. It is equipped with a pressure-regulating knob that allows you to select the right pressure value from 10 to 40 bar for cleaning operations.

Another great advantage is the professional cleaning accessories:

1. Chemical self-priming valve: through siphoning technology, the chemical can be sprayed directly and evenly on the surface of the object to be cleaned.
  2. 220° rotating nozzle and 2 extension wands: it can easily go deep into the narrow space for accurate and rapid cleaning;
  3. 2 meters inlet hose and 38L large-capacity tank: with self-priming function, it can operate easily even where there is no water supply system;
- It is especially suitable for the comprehensive cleaning of industrial and commercial HVAC systems.



Yard Cleaning

Road Cleaning

House Window and Door Washing



Car Cleaning

Farm Cleaning

Commercial Air Conditioner Cleaning

### Accessories



220° Rotational Nozzle

15° Nozzle

Foaming Nozzle

1:3 Ratio Foaming Set

2m Inlet Hose

7m High Pressure Outlet Hose

36cm Extension Rod

High Pressure Spray Gun

### Technical Data

<b>Voltage:</b> 230V~/50-60Hz 100-120V~/50-60Hz	<b>Rated Power:</b> 750W
<b>Max. Pressure:</b> 60bar	<b>Max. Inlet Temperature:</b> 50 °C
<b>Working Pressure:</b> 10-40bar	<b>Pistons:</b> Ceramic-Coated
<b>Flow Rate:</b> 6L/min	<b>Cable Length:</b> 4m

### Triplex Ceramic-coated Pistons

- Long Service Life
- Abrasion Resistance
- More Efficient

### Integrated Storage Design

It can store all accessories as a whole, which is avoid any omissions.

### Variable Pressure

Pressure can be adjusted from 10 bar to 40 bar, covering low to high pressure Cleaning needs, meet a variety of cleaning scenarios.

Steam Cleaner

M6S





# Steam Cleaner

## M6S



### Product Overview

The Multi-functional Steam Cleaner M6S is a device that can meet the cleaning needs of multiple living spaces such as kitchen, living room, bedroom, bathroom and balcony.

Five cleaning modes available: Steam, Hot water, Cold water, Pulse and Disinfection. The machine equipped with 4 meters hose (Steam, Hot water, Cold water in one), integrated voice system, intelligent remote control gun, which is easy to operated and cleaned.

In addition, with the help of Disinfection, odors can be removed while disinfecting quickly. With the Steam mode, it has built a dual disinfection guarantee, which can achieve a sterilization rate of 99.9%. It is safe, environmentally friendly, efficient and reliable.

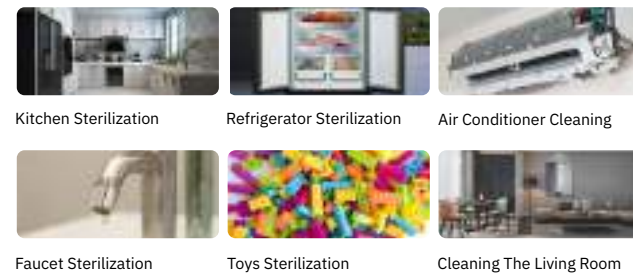

### High Temperature & Pressure Steam

Powerful cleaning with efficient sterilization and disinfection, Pure physical sterilization without residue



### LCD Touch Screen (Voice Alert)

Clearly display the working status, with voice prompts to enhance Using experience



### Intelligent Remote Spray Gun

- Start and stop machine
- Switch cleaning mode, steam & water pressure



### Technical Data

<b>Model:</b> M6S	<b>Voltage:</b> 230V~/50-60Hz 100-120V~/50-60Hz
<b>Heating capacity:</b> 2200/3300W	<b>Steam pressure:</b> 4/6bar
<b>Steam Temperature:</b> 130-150°C	<b>Outlet hose:</b> 4m
<b>Water tank:</b> 10L	<b>Water consumption:</b> 0.1L/min
<b>O<sub>3</sub> capacity:</b> 300mg/h	<b>Air purification:</b> 51-150m <sup>3</sup> /h
<b>Dimensions(LxWxH):</b> 372*292*434mm	<b>Weight:</b> 7.3kg

### Accessories

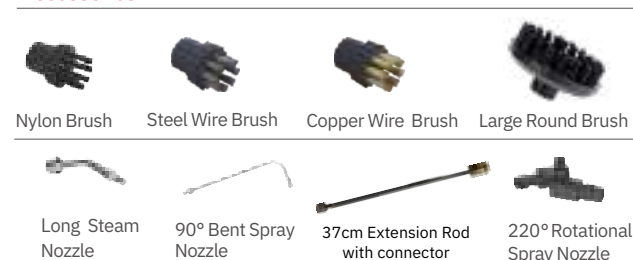



Cordless  
Electrostatic Sprayer

MS4





# Cordless Electrostatic Sprayer

MS4

## Static Charge Generator, Charge Adsorption

Through the built-in electrostatic generator, each sprayed particle is positively charged. Due to the mutual repulsion between the same charge, the cleaning coverage is wider and the effect of spraying on the surface of the object is more even.

# Cordless Electrostatic Sprayer

MS4



## Product Overview

MS4-Cordless Electrostatic Sprayer is based on the physical principle: Like charges repel each other; unlike charges attract.

Through the built-in electrostatic generator, each sprayed particle is positively charged. Due to the mutual repulsion between the same charges, its cleaning coverage is wider, and the effect of spraying on the object surface is more even.

In addition, since most objects have negative or neutral charges on their surfaces, they can just attract particles with positive charges and produce the effect of mutual adsorption with positive charges. They can easily cover the back of objects that are difficult to reach and complete the cleaning efficiently and quickly.

It is very suitable for environmental sanitation and disinfection of families, hotels, airports, food processing, other enterprises, etc.



Gym Disinfecting

Aircraft Disinfecting

Public Transport Disinfecting



Office Disinfecting

Outdoor Disinfecting

**⚡ Electrostatic Charge Generator**  
Patented electrostatic charge penetrates chemical providing a thin even spray pattern on all surfaces

**🔋 18V Lithium Powered**  
Cordless convenience allows for effortless movement room to room.

**💧 16L Capacity Tank**  
Save time and enhance efficiency  
Allowing coat up to 2000 sq. m in one tank

## Technical Data

<b>Voltage:</b> 18V(AEG/RIDGID interface)	<b>Reference Running time:</b> 150mins(2.0Ah)
<b>Optimum Spray Distance:</b> 0.8-2m	260mins(4.0Ah)
<b>Tank Capacity:</b> 16L	<b>Reference Charging time:</b> 120mins(2.0Ah)
<b>Nozzle Spray Sizes:</b> 140 micron	240mins(4.0Ah)
<b>Flow Rate(Max.):</b> 500ml/min	
<b>Remarks:</b>	Due to the strict transportation terms, we can not include any Li-ion battery, you can choose our battery adapters for use your local batteries

## Accessories

Battery Adapters (6 adapters for choice)



# Chiller Tube Cleaner

MTC-1





# Chiller Tube Cleaner

## MTC-1



# Chiller Tube Cleaner

## MTC-1

### Product Overview

MTC-1 is a professional maintenance tool for cleaning tubes/pipes 1/2"-1" (12.7-25.4mm) I.D. in chillers, condensers, evaporators, absorption machines and heat exchangers. It has strong, reliable and durable industrial characteristics. Specially designed for HVAC maintenance technicians.

This compact device integrates accessories storage, tap water washing, self-priming function, bi-directional foot switch, quick connect structure of brush and flexible shaft, makes tough tube cleaning a simple, one-person operation.

Equipped with roller and telescopic pull rod, it is easy to move between different operation sites. The integrated storage box can perfectly store the brush and foot switch, and the retractable pull rod is easy to hang the flexible shaft temporarily, which truly brings a new use experience.



Commercial And Industrial Chiller Cleaning



### Dual Mode for Water Supply

1. A bucket or storage tank
2. Connect directly to the tap water pipe



### Integrated Storage Design

All accessories can be stored, which is safe and can save time.



### Suitcase Appearance

Equipped with rollers and trolleys to move easily



### 2 Directions Foot Switch

Allows to manually control the shaft forward and reverse functionality. Enables faster, more controlled cleaning.

### Technical Data

<b>Voltage:</b> 230V~/50-60Hz 100-120V~/50-60Hz	<b>Brushes:</b> 36pcs(Nylon:18,Copper:9,Steel:9)
<b>Input Power:</b> 370W	<b>Brushes Size:</b> 1/2"-1"
<b>Shaft Speed:</b> 860r/min	<b>Cord Length:</b> 4m
<b>Shaft Length:</b> 7.6m	<b>Weight:</b> 24kg(w/o accessories)
<b>Shaft Size:</b> 12mm	<b>Dimensions:</b> 465*275*528mm
<b>Remarks:</b>	6mm Flexible shaft(7.6m) which cover the brush sizes from (1/4",5/16",3/8",7/16") can be ordered separately.

### Accessories



## Battery Adapter

### One-step conversion for perfect compatibility

MASTO makes an adapter for mainstream batteries in the market, so that you will no longer be troubled by battery problems when using it.  
 Made of high quality ABS, Durable.  
 Designed for six mainstream brands of 18v lithium batteries.

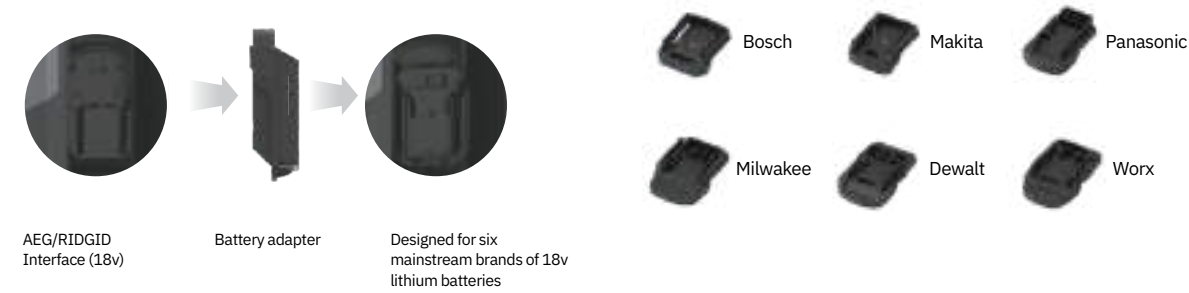

## Battery Converter

### Wired to Convert Unlimited Power

Free from lithium battery run time limitation  
 Ensure unlimited run time of lithium-ion devices

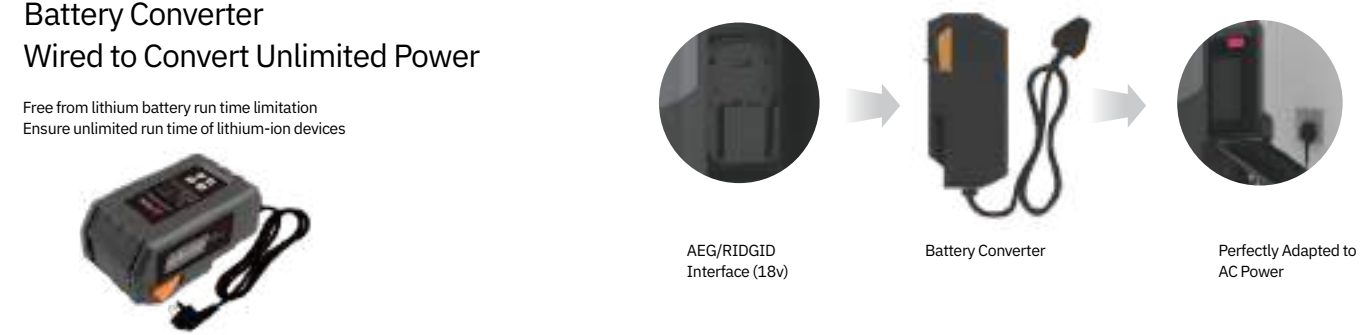

## Accessory Series



## Split A/C Cleaning Cover

### Full Protection, Easy Installation

- Made of artificial PU grade waterproof sealing strip with tight stitches
- Soft, sturdy, waterproof, corrosion resistant and durable
- The adjustable frame can change the length and suit for different split air conditioners
- Transparent front curtain can see coils' cleanliness clearly and prevents splashing
- 4 small back transparent films in the back of the A/C prevents walls from splashing

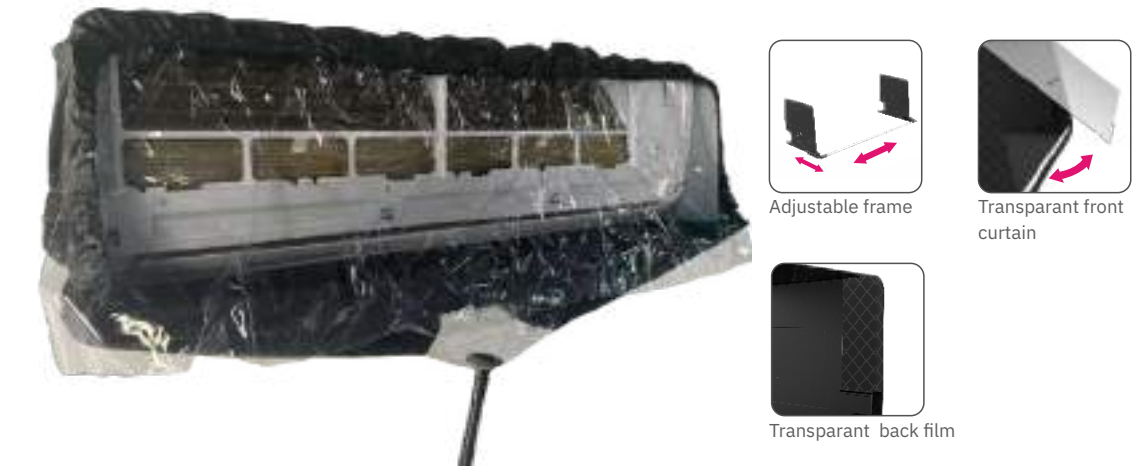

### Technical Data :

Size(mm)  
 H:280\*W:280\*L700-1000(adjustable)

## Ceiling A/C Cleaning Cover

- Widened collection surface, fully catch the waste water during cleaning
- Integrated connection design, make the assemble and disassemble easily
- Whole piece of waterproof fabric cloth to avoid any water leakage
- Come with a stretched suspension plate, free to adjust cover height easily



### Technical Data :

Size  
 125cm

Outlet hose  
 3m