



FD-650M_J(Z)-C

Modular Cubelet Ice Machine
Slim-Line Dispenser Series



FD-650M_J(Z)-C
08/03/23
Item # 13464

W x D x H
22" x 24" x 26"

FD-650MAJ-C
Air-Cooled

FD-650MWJ-C
Water-Cooled
Shown on optional
Lancer 30" Dispenser

FD-650MRJZ-C ★
Remote Air-Cooled



Item #: _____
Project: _____
Qty: _____
AIA#: _____

Features

- ▶ Durable stainless steel exterior
- ▶ Advanced CleanCycle24™ design 
- ▶ Stainless steel auger with greaseless bearing

- Up to 634 lbs. of ice production per 24 hours
- 2 second flush cycle every hour
- Flush cycle removes sediment for cleaner ice
- Infrared bin control for easy cleaning and reliability
- Protected by H-GUARD Plus Antimicrobial Agent 
- R-404A Refrigerant

Available on Bins:

B-250SF B-500SF B-700S B-800SF B-900SF

Top kit may be required; See Bin Spec Sheets.

Warranty:

3 Year Parts & Labor on entire machine. 5 Year Parts on Compressor; air-cooled condenser coil. Valid in United States, Canada, Puerto Rico and U.S. Territories. Contact factory for warranty in other countries.

Shipping: (LxWxH) 28.5" x 26.75" x 32" Volume: 14.12ft³

Condenser	Model	ICE PRODUCTION		WATER USAGE		ELECTRICAL							
		Air / Water Temp Lbs. per 24 hours 70°/ 50°F 90°/ 70°F	Potable Gal. per 100 lbs. 90°/ 70°F	Condenser Gal. per 100 lbs. 90°/ 70°F	kWh Used per 100 lbs. 90°/ 70°F	Min. Circuit/ Max. Fuse Size	Amperage	Voltage	Circuit Wires (including ground)	Heat Rejection BTU/hr.	Refrigerant Charge Amount	Net / Ship Weight (lbs.)	
Air	FD-650MAJ-C	634	495	12.0	N/A	5.50	20A	11.3A	115V/60/1	3	6,800	12.3 oz.	176 / 185
Water	FD-650MWJ-C	622	520	12.0	95.3	4.02	20A	7.9A	115V/60/1	3	5,400	15 oz.	176 / 185
Remote	FD-650MRJZ-C	588	470	12.0	N/A	4.95	20A	10.9A	115V/60/1	3	5,900	2 lbs. 3.3 oz. 4 lb. 1 oz.*	176 / 185

*(with condenser)

Cube Dimensions*

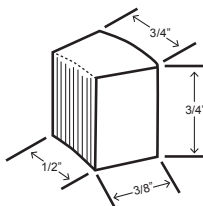

* approximate size in inches, image not to scale

Operating Limits

- Ambient Temp Range 45 - 100°F
- Water Temp Range 45 - 90°F
- Water Pressure 10 - 113 PSIG
- Voltage Range 104-127V
- If GFCI is required, a GFCI breaker MUST be used in lieu of GFCI receptacle

Service

- Panels easily removed and all components accessible for service.
- Allow 24" (61 cm) clearance at top for removal of auger and 6" (15 cm) clearance at rear and sides for proper air circulation and ease of maintenance/service.

Plumbing

- Icemaker Water Supply Line: Minimum 1/4" Nominal ID Copper Water Tubing or Equivalent
- Icemaker Drain Line: Minimum 3/4" Nominal ID Hard Pipe or Equivalent
- Water-Cooled Model (Lines Must Be Independent of Icemaker)
- Condenser Water Supply Line: Minimum 1/4" Nominal ID Copper Water Tubing or Equivalent
- Condenser Drain/Return Line: Minimum 1/4" Nominal ID Hard Pipe (open drain system) or Copper Water Tubing (closed loop system) or Equivalent

Hoshizaki reserves the right to change specifications without notice.



FD-650M_J(Z)-C

Modular Cubelet Ice Machine
Slim-Line Dispenser Series

FD-650M_J(Z)-C
08/03/23
Item # 13464

FRONT VIEW

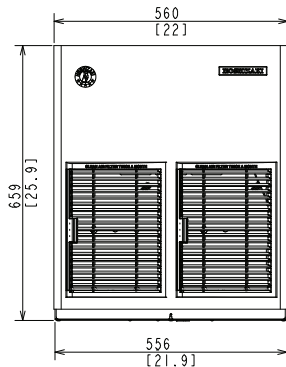

AIR-COOLED

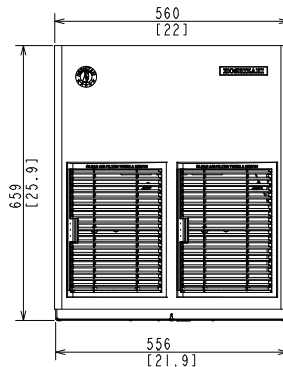

WATER-COOLED

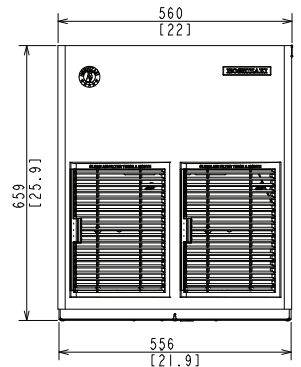

REMOTE AIR-COOLED

inch
[mm]

SIDE VIEW

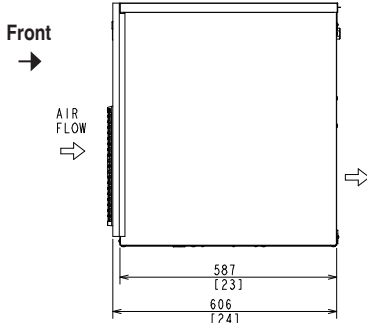

AIR-COOLED

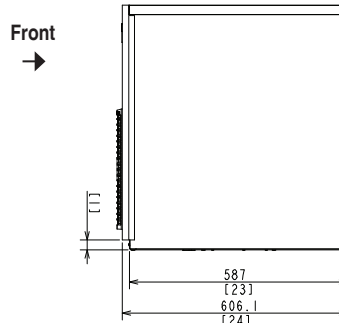

WATER-COOLED

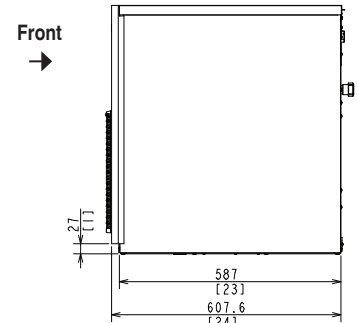

REMOTE AIR-COOLED

REAR VIEW

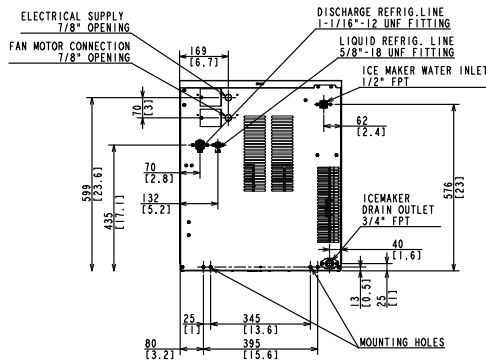

AIR-COOLED

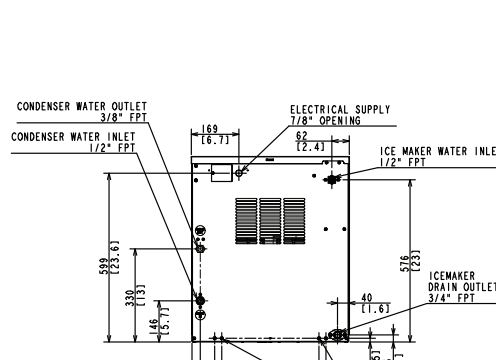

WATER-COOLED

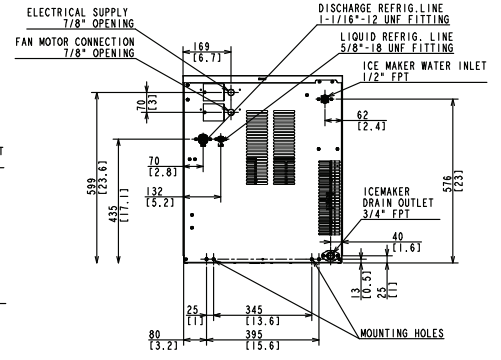

REMOTE AIR-COOLED

BOTTOM VIEW

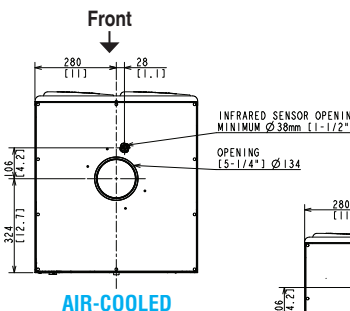

AIR-COOLED

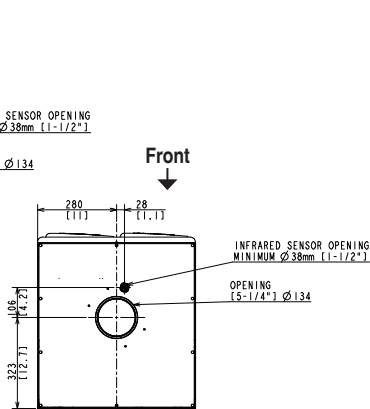

WATER-COOLED

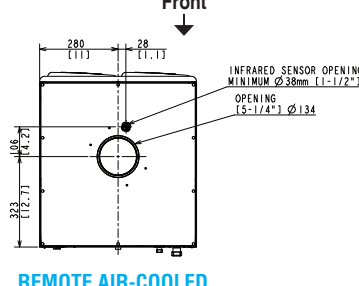

REMOTE AIR-COOLED

URC-5FZ Remote Condenser (Sold Separately)
(W x D x H) 21 13/16 x 14 1/16 x 32 13/16
For Use with FD-650MRJZ-C

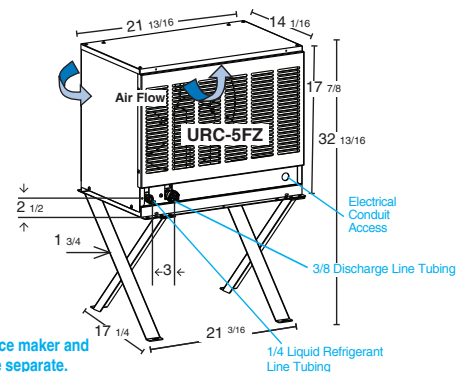

Brazed Line Sets
(Sold Separately)
25' HS-5587
35' HS-5588

Voltage supply for ice maker and
condensing unit are separate.